



## J95 HEAVY DUTY CONCEALED HINGES / PLATES



J95 Thick Door Inset Hinges used on 31" W x 93" H door.

- Load capacity: **55 lbs** w/ 2 hinges, **88 lbs** w/ 3 hinges
- Doors up to **6' 6" tall!**
- Clip on type for easy installation
- 3-way adjustment with door installed
- Requires 6 M5 or equivalent (US#10) screws: 2 screws for each hinge, and 4 screws for each mounting plate.
- Requires J95-P6T Mounting plate
- 40mm cup dia.

For a single pair, the Max weight is 55 lbs. (25 kg)  
3 Hinges Max weight is 88 lbs. (42 kg)

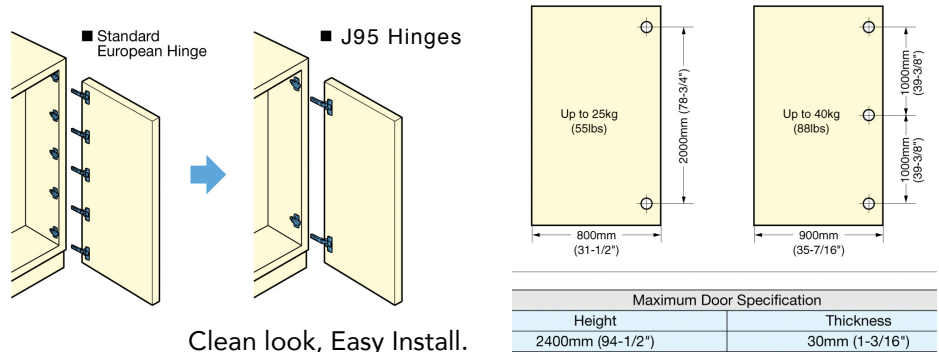

Clean look, Easy Install.

**J95-C24-25T**  
Self-Closing  
Overlay (20-25mm)



**J95-C24-16T**  
Self-Closing  
Half Overlay (16mm)



**J95-C24-0T**  
Self-Closing  
Inset



**J95-P6T plate**

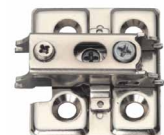

### J95 Hinge and Plate Cover Caps

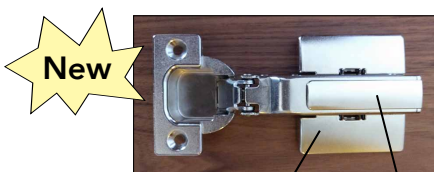

Baseplate Cover Cap



Hinge Arm  
Cover Cap

Code	Description	Ctn	List/ea
J95-C24-25T	HD Overlay hinge, Self-Closing, 40mm cup	10	\$ 18.00
J95-C24-16T	HD Half Ovrly hinge, Self-Closing, 40mm cup	10	20.00
J95-C24-0T	HD Inset hinge, Self-Closing, 40mm cup	10	22.00
J95-P6T	Mounting Plate, Frameless, 3-cam	10	9.00
<b>J95FO-H-NI</b>	Full Overlay Hinge Cover, Nickel	100	\$ 6.50
<b>J95HO-H-NI</b>	Half Overlay Hinge Cover, Nickel	100	6.50
<b>J95I-H-NI</b>	Inset Hinge Cover, Nickel	100	6.50
<b>J95-P-NI</b>	Baseplate Cover, Nickel	100	7.00

Hinge & plate specifications on back

## J95 Hinge & Plate Specifications

- Vertical adjustment:  $\pm 3\text{mm}$  ( $\pm 1/8''$ )
- Overlay adjustment:  $+0/-4\text{mm}$  ( $\pm 5/32''$ )
- Depth adjustment:  $+1.5/-2.5\text{mm}$  ( $\pm 5/32''$ )

### J95-C24-25T - Overlay

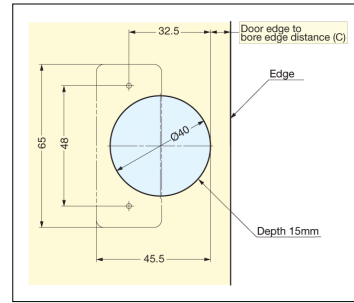

Bore Dimensions

■ Door edge to bore edge distance (C) and Overlay distance (E) Table 1.

Door edge to bore edge distance (C)	3	4	5	6	7	8
Overlay distance (E)	20	21	22	23	24	25

■ Hinge side opening clearance chart Table 2.

Door thickness (D)	Door edge to bore edge distance (C)					
	3	4	5	6	7	8
18	0.3	0.3	0.3	0.3	0.3	0.3
20	0.5	0.5	0.5	0.5	0.5	0.5
22	0.8	0.8	0.8	0.7	0.7	0.7
24	1.1	1.1	1.1	1.1	1.1	1.1
26	1.7	1.6	1.6	1.5	1.5	1.5
28	3.2	2.8	2.5	2.2	2.1	2.0
30	5.0	4.5	4.0	3.6	3.3	3.0
32	6.8	6.2	5.7	5.2	4.8	4.4
34	8.6	8.0	7.5	6.9	6.5	6.0
Hinge side O.C. (B)						

\*Mounting Plate sold separately.

\*If the door thickness is over 30mm (1-3/16") the frame will need to be chamfered.

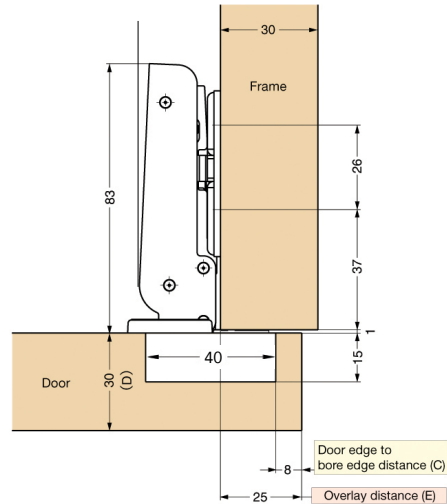

### J95-C24-0T - Inset



■ Door edge to bore edge distance (C) and Hinge side O.C. (b) Table 1.

Door edge to bore edge distance (C)	3	4	5	6	7	8
Hinge side O.C. (b)	6	5	4	3	2	1

■ Hinge side opening clearance chart Table 2.

Door thickness (D)	Door edge to bore edge distance (C)					
	3	4	5	6	7	8
18	0	0	0	0	0	0
20	0	0	0	0	0	0
22	0.1	0.1	0.1	0.1	0.1	0.1
24	0.1	0.1	0.1	0.1	0.1	0.1
26	0.3	0.3	0.3	0.3	0.3	0.3
28	1.7	1.1	0.6	0.5	0.5	0.5
30	3.5	2.9	2.3	1.8	1.0	0.9
32	5.4	4.7	4.1	3.6	3.0	2.5
34	7.3	6.0	6.0	5.4	4.8	4.3
Hinge side O.C. (B)						

\*If the door thickness is over 30mm (1-3/16") the door will need to be chamfered.

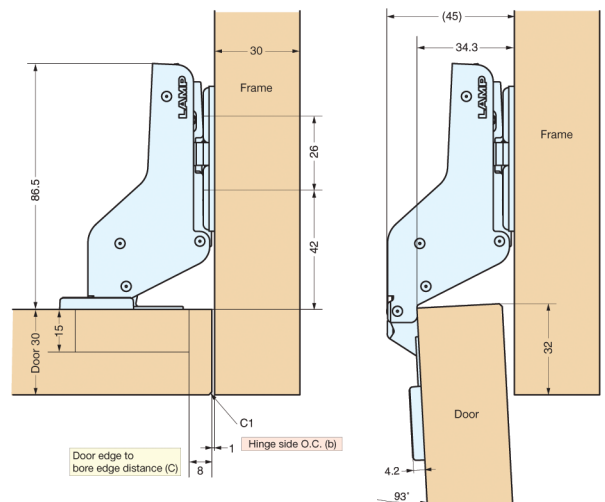

## J95-C24-16T - Half Overlay



■ Door edge to bore edge distance (C) and Overlay distance (E) Table 1.

Door edge to bore edge distance (C)	3	4	5	6	7	8
Overlay distance (E)	11	12	13	14	15	16

■ Hinge side opening clearance chart Table 2.

Door thickness (D)	Door edge to bore edge distance (C)					
	3	4	5	6	7	8
18	0.3	0.3	0.3	0.3	0.3	0.3
20	0.5	0.5	0.5	0.5	0.5	0.5
22	0.8	0.8	0.8	0.7	0.7	0.7
24	1.1	1.1	1.1	1.1	1.1	1.1
26	1.7	1.6	1.6	1.5	1.5	1.5
28	3.2	2.8	2.5	2.2	2.1	2.0
30	5.0	4.5	4.0	3.6	3.3	3.0
32	6.8	6.2	5.7	5.2	4.8	4.4
34	8.6	8.0	7.5	6.9	6.5	6.0
Hinge side O.C. (B)						

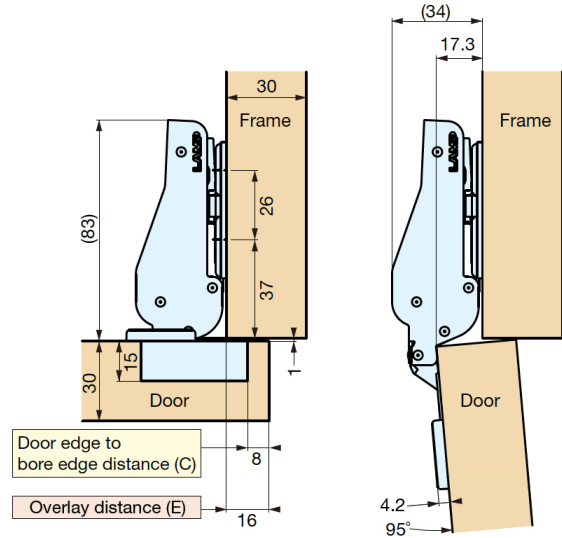

## J95-P6T - Frameless Mounting Plate

