

HERA HALOGEN

HERA RECESSED HALOGEN - 1/16" Ht.

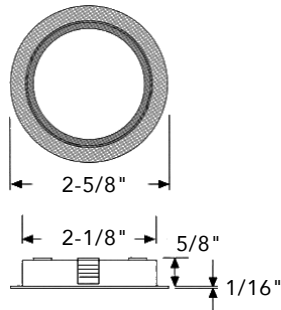

20 watt Halogen friction recess fixture with surface height of 1/16". Aluminum reflector in silver. Tempered glass, frosted lens. 12V. Attached 72" connecting cable with NV6 plug.

Code	Color	Ctn	List/ea
KB1220BL	Black Matte	1 ea.	\$ 54.97
KB1220WH	White Matte	1	49.97

PRESS-IN SPOTLIGHT

ARF20 Series

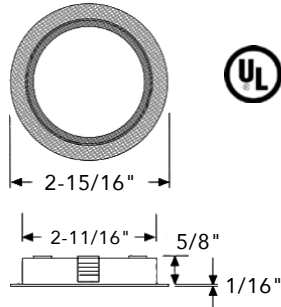

Halogen. Press-in fit. No screws for installation. Very low profile trim ring; only 1/16" thick. Requires 68mm hole saw. Includes 79" Connecting cable. Snap-in installation. Osram bulb rated 4000 hr.

Code	Color	List
ARF20BL	Black Matte	\$ 74.96
ARF20WH	White Matte	74.96
ARF20GO	Gold	69.76
ARF20SS	St. Steel Matte	76.73
ARF20CH	Chrome	69.76

TRANSFORMERS

HERA ECOLINE TRANSFORMER

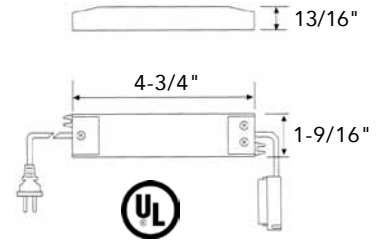

Electronic Transformer supports 12 volt fixtures up to a combined wattage of 60 watts. Plug-in or hard-wiring capability with included 79" plug-in cable and the 10" 12V connector with NVK6/3 terminal. Short circuit and overload protection. Soft start. Dimmable with standard dimmers. Weighs only 4 ounces. Gray color. Pack: 12 ea.

Code	Description	List/ea
UE-E60FT	Ecoline Transformer, 13/16" Ht. Accommodates 3 ea. 20W lights	\$ 61.70

HERA ELECTRONIC TRANSFORMER

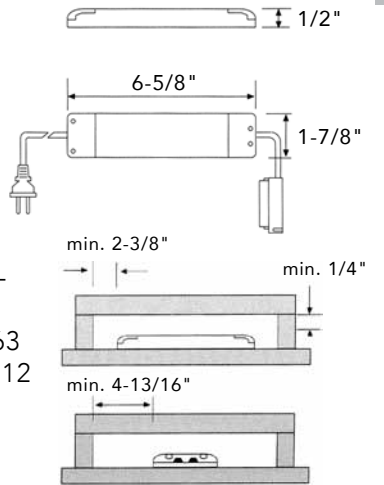

Electronic Plug-in or hard-wiring capability with 79" main connector and NVK63 terminal block. Supports 12 volt fixtures up to a combined wattage of 10 to 60 watts (UC-60FT) or 10 to 120 watts (UK-120TW).

Plug-in or hard-wiring capability with included 79" plug-in cable and the 10" 12V connector with NVK6/3 terminal. Short circuit and overload protection. Soft start. Dimmable with standard dimmers. Weighs only 4 ounces. Includes RF suppression for commercial applications. White color. Pack: 6 each.

Code	Description	List/ea
UC-60FT	60 watt Transformer: 1/2" Ht. Accommodates 3 ea. 20W lights	\$ 102.26
UK-120TW	120 watt Transformer, 13/16" Ht. Accommodates 6 ea. 20W lights or 12 ea. 10W lights	188.67

HERA PARTS

HERA TOUCH DIMMER
110V/500 Watt

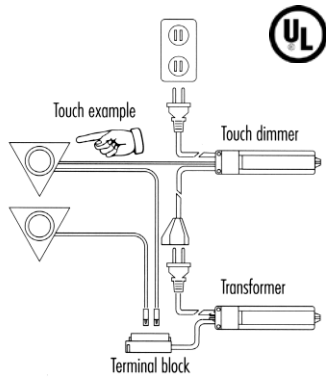

For Halogen Lights. Touch dimmer can control up to 300 watts. Comes with 10' power cord, 12" 3-outlet female end and 3' "touch wire." Transformers plug into dimmer and dimmer plugs into wall outlet. "Touch wire" attaches to anything metallic (hinge, knob, screw, etc.).

4 dimming levels: off, 50%, 75% and 100%.
Size: 4-1/4" L x 1-3/8" W x 1-3/8" H.

Code	Description	List/ea
ETD-1	Touch Dimmer	\$ 62.64

HERA ROTARY DIMMER
110V/630 Watt

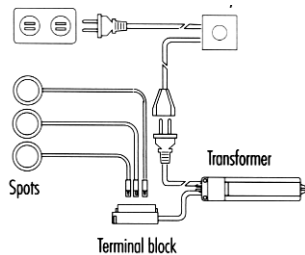

For Halogen Lights. The rotary dimmer can control up to 300 watts. Provides linear dimming from 0 to 100%. Easy installation. No wiring necessary. Fits behind standard switch plate.

Code	Description	Box Size	List/ea
ERD-1	Rotary Dimmer	2"W x 2"L x 7/8"H	\$ 46.18

HALOGEN

CABLE 2NV6

Low voltage cable for variable length connections between Hera transformer and halogen spotlights.



Code	Length	Ctn	List/ea
2NV6500	20"	6 ea.	\$ 7.12
2NV61000	39"	6	8.21
2NV62000	79"	6	10.71
2NV63000	119"	6	13.21

ECOLINE BULB

G4 socket, Halogen
Rated 2000 hrs.



Code	Description	List/ea
EB10	10 Watt Clear	\$ 4.56
EB20	20 Watt Clear	4.56
EBF20	20 Watt Frosted	3.79

TERMINAL BLOCKS

Low voltage connector for all Hera 10W halogen spotlights.



Code	Description	List/ea
NVK64	Four Sockets	\$ 15.35

HERA PARTS - HALOGEN

GLASS LENSES



Pack: 6 each

<u>Code</u>	<u>For Fixture/Color</u>	<u>List/ea</u>
GLFR	AH11/EH11, Frosted	\$ 6.77
GLCL	AH11/EH11, Clear	7.45

HARDWIRE BOX

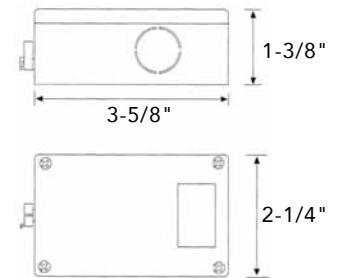

SHWC (no switch)
SHWC/S (with switch)

<u>Code</u>	<u>Description</u>	<u>List/ea</u>
SHWC	Hardwire Box, No Switch	\$ 27.25
SHWC/S	Hardwire Box, W/ Switch	29.98

10

HOLE SAW SIZES FOR HERA SPOTLIGHTS



<u>Code</u>	<u>mm</u>	<u>inches</u>	<u>Hera Series</u>	<u>List/ea</u>
HS134	44	1-3/4"	EH2420 - Premium Swivel Spot	\$ 21.58
HS218	54	2-1/8"	ER/ES120 - Ecoline Spots	25.87
HS214	57	2-1/4"	EH1120 - Premium Spots or Ecoline w/ spring clip	24.31
HS21116	68	2-11/16"	ARF20 - Press-in Spot	26.49



XENON LIGHTS



Xenon



XENON POCKET LIGHTS - METAL POCKET

- Durable all metal construction
- Frosted lens for a diffused light
- Low profile (1/16")
- Recess 2-1/8" Dia. or surface mount
- Push-on ring for easy bulb replacement
- 20W Xenon bulb
- 12V low voltage
- 2900K color temp
- 5,000 hr. bulb life
- 79" cord



REQUIRED PARTS

XENON LIGHTS

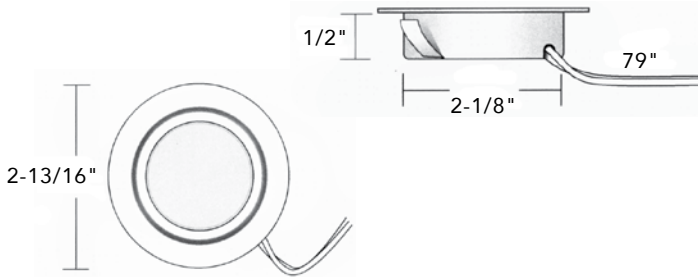

Code	Color	List/ea
POC-20WX-BL-M	Black	\$ 26.53
POC-20WX-NI-M	Nickel	22.81
POC-20WX-WH-M	White	22.16

TRANSFORMER for XENON LIGHTS

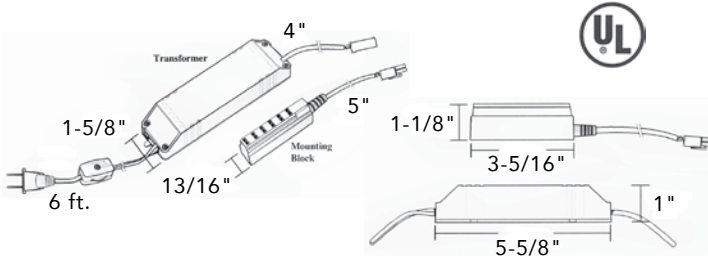

60W Transformer. Power cord with roll switch. Snap block with male/female connectors. Short circuit and overload protected with auto reset. RF1 protection.

Code	Description	List/ea
SL-ELT60-CON	12VAC, 60W, White	\$ 58.44

OPTIONAL ACCESSORIES

See Tresco Accessories next page for further details.

METAL RINGS FOR SURFACE MOUNT

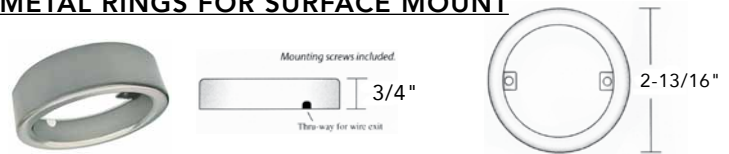

Code	Finish	List/ea
SPACER-BL-M	Black	\$ 3.54
SPACER-NI-M	Nickel	5.50
SPACER-WH-M	White	3.54

Code	Description	List/ea
TS2-72	Touch On/Off Switch	\$ 50.04
TD4-72	4 Step Dimming Touch Dimmer	48.12
RDSW-2M-WH	Round Switch, White	18.91
RDSW-2M-BL	Round Switch, Black	18.91
EXT-1M	39" Extension Cord	7.22
EXT-3M	118" Extension Cord	10.14
LB-20X	Xenon Repl. Bulb	12.03
MALEAMP	Amp Connector	12.03



TRESCO ACCESSORIES

TOUCH DIMMER

For Pocket Xenon Lights

Touch Dimmer pad attaches to surface with adhesive backing. Transformer plugs in to dimmer. White.

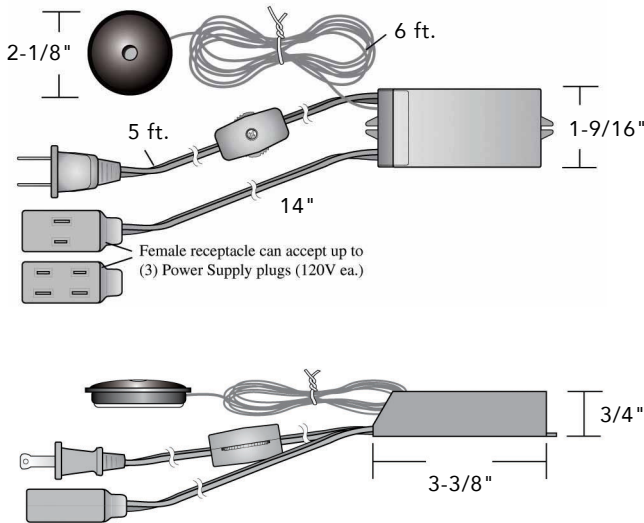

Code	Description	List/ea
TD4-72	4 Step Dimming Touch Dimmer	\$ 48.12

XENON REPLACEMENT BULBS

G4 Base, 5000 hrs.

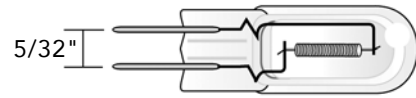

Code	Description	List/ea
LB-20X	20W Xenon Bulb	\$ 12.03

REPLACEMENT BULBS - MR16 LED 3W

For iMAGine Power Track System

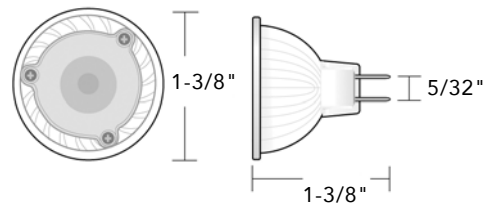

Code	Description	List/ea
LEDMR16-3W-CBL	3W, 4800K, Black	\$ 55.03
LEDMR16-3W-CNI	3W, 4800K, Nickel	55.03
LEDMR16-3W-CWH	3W, 4800K, White	55.03

10

POCKET XENON EXTENSION CORDS

For Pocket Xenon Lights

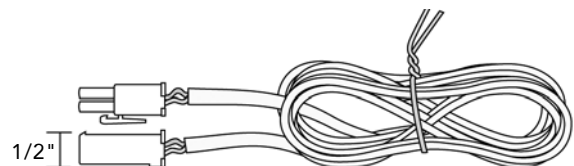

Code	Description	List/ea
EXT-1M	39" Extension Cord	\$ 7.22
EXT-3M	118" Extension Cord	10.14

FLUORESCENT SLIM LITES

HERA

SLIM LITE FROM HERA

1-1/4" high, 11/16" wide

Soft, even slim lighting



Line Voltage:
No Transformer Needed

The compact Hera SlimLite fits in even the narrowest spaces. Easy to install with a snap-in system. You can also combine several fixtures effortlessly. The modular connecting system makes it simple to create long, continuous lines of fluorescent lighting to fit any space. Tri Phosphor lamp. UL listed.

- Sizes: 10", 13", 20", 35", 46", 58"
- Built-in electronic ballast
- Slender profile fits virtually any furniture or display
- Easy-to-clean plexiglass cover protects bulb
- Instant starting, lamp is quiet and flicker-free
- Easy installation—screw in two clips, fixture snaps in
- Plug-in modular system permits easy connection for continuous lighting, max. 200 watts per power supply
- Long bulb life, rated 10,000 hours
- Cool white = 4100K, Warm white = 3450K

Code	Description	List/ea
ES10	10" long, 7W	\$ 85.08
ES10WW/P	10" long, 7W, warm white	85.08
ES13	13" long, 10W	85.63
ES13WW/P	13" long, 10W, warm white	85.63
ES20	20" long, 18W	86.74
ES20WW/P	20" long, 18W, warm white	86.74
ES34/BC	34-7/8", 21W	153.91
ES34WW/BC	34-7/8", 21W, warm white	153.91
ES46/BC	46-3/4", 28W	157.25
ES59/BC	58-7/16", 35W	165.32

SLIM LITE CONNECTIONS

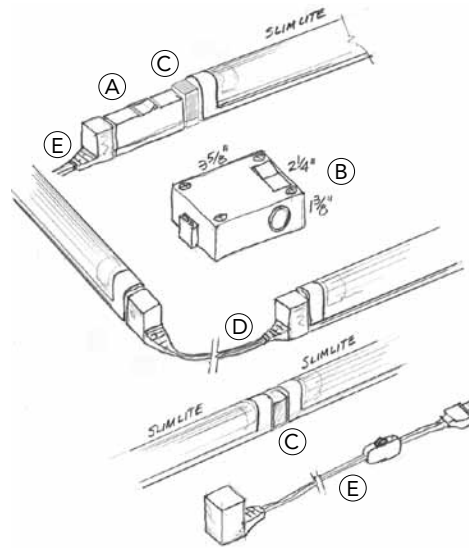

- A. Inline Switch (SRS)
- B. Hardwire Box w/Switch SHWC/S w/o Switch SHWC
- C. Direct Connector SDC
- D. Connecting Cable SCC
6", 12", 24", 48", 72"
- E. Power Cord w/Switch SPC-S w/o Switch SPC



Code	Description	List/ea
SCC6	Connecting Cable, 6"	\$ 7.23
SCC12	Cable, 12"	7.51
SCC24	Cable, 24"	9.63
SCC48	Cable, 48"	9.74
SCC72	Cable, 72"	10.11
SPC	Power Cord, 6'	8.91
SPC-S	Power Cable W/ Switch	12.23
SMC	Mounting Clip	3.35
SDC	Direct Connector	2.78
SRS	On/off Rocker Switch	15.74
SFB7CW	Replacement bulb, 7W, cool wht	18.91
SFB7WW	Replacement bulb, 7W, wm wht	25.95
SFB10CW	Replacement bulb, 10W, cool wht	19.46
SFB10WW	Replacement bulb, 10W, wm wht	19.46
SFB18CW	Replacement bulb, 18W, cool wht	21.73
SFB18WW	Replacement bulb, 18W, wm wht	20.30
SFB21CW	Replacement bulb, 21W, cool wht	21.97
SFB35CW	Replacement bulb, 35W, cool wht	23.91
SHWC	Hardwire Box	27.25
SHWC/S	Hardwire Box w/switch	29.98

HERA

LED SPOTLIGHTS

HERA KB12 LED SPOTLIGHTS

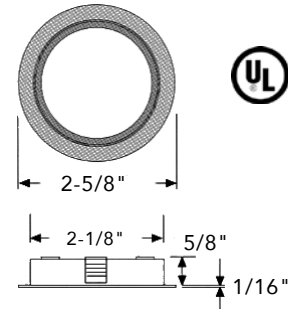
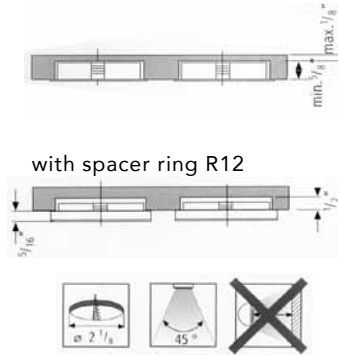

High Quality LED Spotlight at a Mid-Level Price. The KB12-LED is a German made LED spotlight, available at a very attractive price. It features 25 latest generation SMD LEDs which provide a high and even light output while using only 1.6 W of energy; replaces 20 W Halogen. Can be surface and recessed mounted and is perfect for kitchen cabinet and furniture applications.

- Recess depth only 5/8" or 1/2" (with spacer ring R12)
- When surface mounted, overall height 1"
- Friction fit
- Only 1.6 Watt power consumption; rated 30,000 hrs.
- Warm White (3250K) or Cool White (5350K)
- Stocking Black & Stainless Steel finishes
- Attached 98" connecting cable w/ plug-in connector
- To be used with 24 Vdc LED driver
- Special accessories available:
R12 - Spacer ring to reduce recess depth

Code	Description	List/ea
KB12LEDBL/WW	LED Spot, Black, WW	\$ 106.72
KB12LEDBL/CW	LED Spot, Black, CW	106.72
KB12LEDSS/WW	LED Spot, Stainless Steel, WW	106.60
KB12LEDSS/CW	LED Spot, Stainless Steel, CW	106.72
STICKPS24/6	Constant Voltage Drive, 25W	52.71
STICKPS24/30	" ", 30W	104.21
STICKPS24/75	" ", 75W	207.17

HERA ER/EQ LED

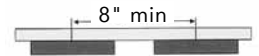
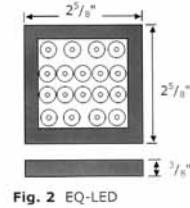
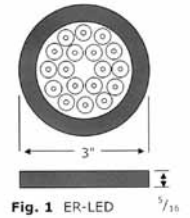

High quality ER-LED and EQ-LED feature an energy saving, surface mounted spotlight perfect for under cabinets in kitchens, bathrooms or displays using only 1.2 Watts; replaces 15 W Halogen. Easy installation with no need to drill holes into cabinets.

- Surface Mount, Slim 5/16" profile
- Long life, rated at 30,000 hours
- Energy efficient - only 1.2 Watts
- Stainless Steel finish in either Round or Square Design
- Cool White (5350K) or Warm White (3250K)
- ER-LED height only 5/16", EQ-LED height only 3/8"
- Attached 98" connecting cable with plug-in connector
- To be used with 24 Vdc LED Driver
- Compatible with Hera 24 V LED switching accessories
- Dimmable with optional accessories

Code	Description	List/ea
ERLEDSS/WW	LED spot, Round, WW	\$ 72.50
ERLEDSS/CW	LED spot, Round, CW	72.48
EQLEDSS/WW	LED spot, Square, WW	72.48
EQLEDSS/CW	LED spot, Square, CW	72.48
STICKPS24/6	Constant Voltage Driver 6W	52.71
STICKPS24/30	Constant Voltage Driver 30W	104.21
STICKPS24/75	Constant Voltage Driver 75W	207.17
KB12LEDCC39	Connecting Cable, 39"	5.18
KB12LEDCC98	Connecting Cable, 98"	7.44
STICKPSDIM	Dimmer	56.17
DIMCONTROL	Dimmer Controller	179.58
STICKDIM/YCABLE*	Distributor Cable	22.03
IRSWITCH	Infrared Switch	41.51
RCPSDIM	Remote Control Dimmer	130.40
STICKTB	Terminal Block	10.48

* Special Order

STICK - LED LIGHTING

HERA

HERA MINIATURE LED LIGHTING WITH CONNECTING SYSTEM

Features

- Aluminum and plexiglass housing
- Small dimensions: width: 3/8", height: 5/16"
- Available in two different sizes: 8" and 12"
- Available with cool white (4300K) and warm white (3250K) LEDs, as well as special color for meat cases
- Extremely high, even light output
- Up to 8' of Stick-LEDs can be connected per run - Plug end to end or use flexible connecting cable
- To be used with 24 V LED driver (part #s below)
- Rated 50,000 hours per fixture

<u>Code</u>	<u>Description</u>	<u>List/ea</u>
STICK2/8/WW	8" long, 1.6W, WW	\$ 83.09
STICK2/12/WW	12" long, 2.4W, WW	122.67
STICK2/PC	Power Cord, 98" long	9.14
STICK2/CC1	Connecting Cable, 1-3/16"	3.69
STICK2/CC12	Connecting Cable, 12"	4.52
STICK2/CC39	Connecting Cable, 39"	5.45

HERA DRIVERS

For Stick-LED, TwinStick-LED, KB12 & ER/EQ Spotlights

Features

- 110 V, 50/60 Hz
- 24 Vdc
- Overload protection
- Overheat protection
- Short-circuit protection
- Soft start for maximum LED life
- 79" power cord
- Attached terminal block for 6 x Stick-LED runs

<u>Code</u>	<u>Description</u>	<u>List/ea</u>
STICKPS24/6	6W, 24 Vdc Driver	\$ 52.71
STICKPS24/30	30W, 24 Vdc Driver	104.21
STICKPS24/75	75W, 24 Vdc Driver	207.17
STICKPSDIM	Dimmer	56.17

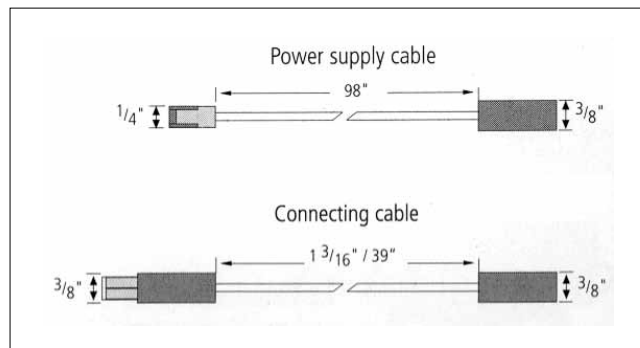
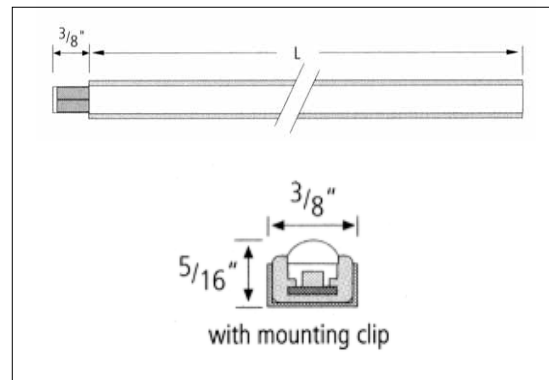
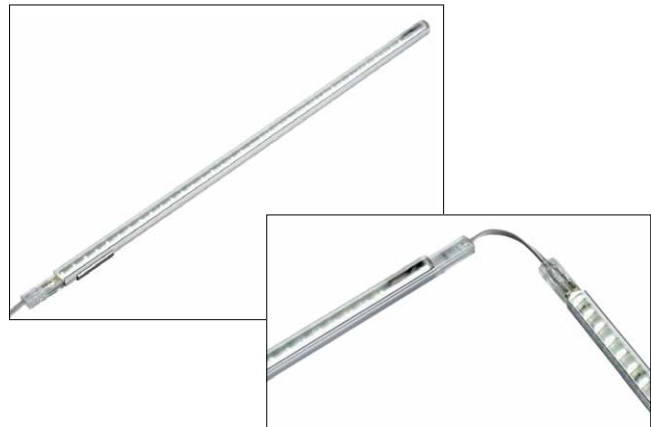

HERA

TWIN STICK - LED

HERA COMPACT LED LIGHTING WITH CONNECTING SYSTEM

Features

- Aluminum and plexiglass housing
- Small dimensions: width: 11/16", height: 5/16"
- Available in two different sizes: 8" and 12"
- Available with cool white (4300K) and warm white (3200K) LEDs, as well as special color for meat cases
- Extremely high, even light output
- Up to 8' of Twinstick-LEDs can be connected per run - Plug end to end or use flexible connecting cable
- To be used with 24 V LED driver
- Rated 50,000 hours per fixture

<u>Code</u>	<u>Description</u>	<u>List/ea</u>
TWINSTICK2/8/WW	8" long, 3W, WW	\$ 143.11
TWINSTICK2/12/CW	12" long, 4.4W, CW	178.88
TWINSTICK2/12/WW	12" long, 4.4W, WW	178.88
TWINSTICK2/PC	Power cord, 98" long	12.39
TWINSTICK2/CC1	Connecting cable, 1-3/16"	5.76
TWINSTICK2/CC12	Connecting cable, 12"	7.13
TWINSTICK2/CC39	Connecting cable, 39"	8.70

HERA DRIVERS

For Stick-LED, TwinStick-LED, KB12 & ER/EQ Spotlights

Features

- 110 V, 50/60 Hz
- 24 Vdc
- Overload protection
- Overheat protection
- Short-circuit protection
- Soft start for maximum LED life
- 79" power cord
- Attached terminal block for 6 x Stick-LED runs

<u>Code</u>	<u>Description</u>	<u>List/ea</u>
STICKPS24/6	6W, 24 Vdc Driver	\$ 52.71
STICKPS24/30	30W, 24 Vdc Driver	104.21
STICKPS24/75	75W, 24 Vdc Driver	207.17
STICKPSDIM	Dimmer	56.17

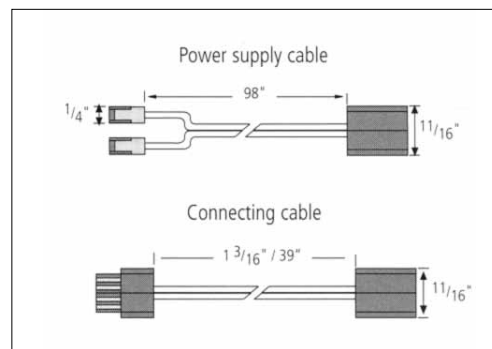
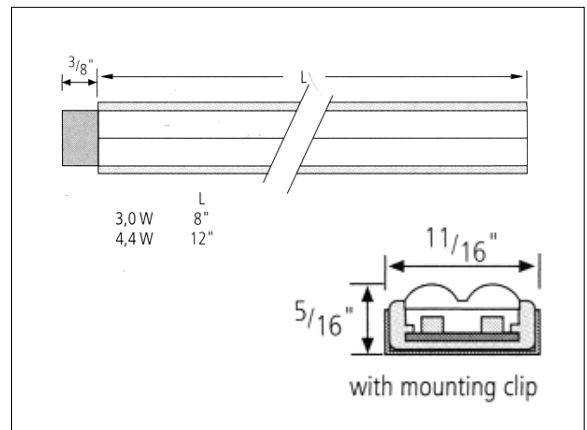

10

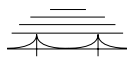

LED POCKET LIGHTS



1W POCKET LED LIGHTS

- Warm White - 2700K (Cool White avail. special order)
- 25,000 hour life
- 90° light spread
- Replaceable 1W AC/DC LED chip
- Durable all metal construction
- Easy push-on ring for quick LED replacement
- 79" cord, Dimmer available
- Recess or Surface mount

REQUIRED PARTS

1W LED POCKET LIGHTS - Metal

2700K color temperature. Replaceable LED chips. Order surface mounting ring separately

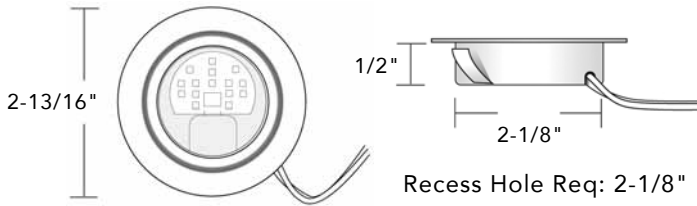

Code	Color	List
POC-LED-WWH-M	White	\$ 47.78
POC-LED-WBL-M	Black	47.78
POC-LED-WNI-M	Nickel	48.71

Takes any ELT Transformer 6W to 60W.

18W TRANSFORMER: DC-ELT18-CON List \$ 63.05

1W - 18 lights max. Includes mounting block and power cord. For an extra 6-snap mounting block order TRANS-MNT-BL). Black.

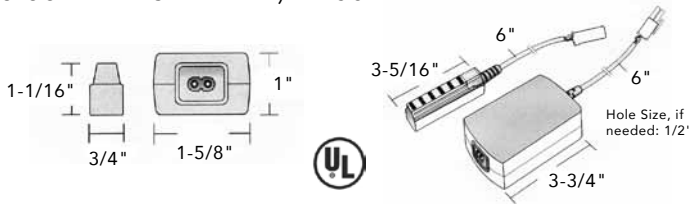

60W TRANSFORMER: DC-ELT60-CON List \$ 74.55

1W - 60 lights max. Includes mounting block and power cord. For an extra 6-snap mounting block order TRANS-MNT-BL). Black.

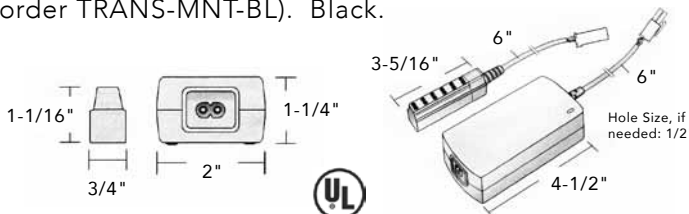

OPTIONAL ACCESSORIES

See Tresco Accessories pages 1020-1025 for further details.

METAL RINGS FOR SURFACE MOUNT

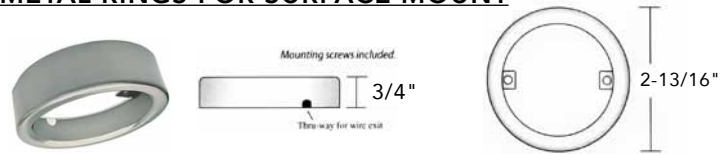

Code	Finish	List/ea.
SPACER-BL-M	Black	\$ 3.54
SPACER-NI-M	Nickel	5.50
SPACER-WH-M	White	3.54

Code	Description	List
TS2-72	Touch On/Off Switch	\$ 50.04
RDSW-2M-WH	Round Switch, White	18.91
RDSW-2M-BL	Round Switch, Black	18.91
TRANS-MNT-BL	6-Snap Mounting Block	11.17
LED-LINKD-25	Extension Cord, 10"	6.19
LED-LINKD-60	Extension Cord, 24"	7.91
LED-LINKD-120	Extension Cord, 48"	8.47
LED-LINKD-180	Extension Cord, 72"	10.31
LED-DIMRMT-12V8A	LED Dedicated Remote Control Dimmer	82.50
LED-DIMRMT-12V8A-U	LED Universal Remote Control Dimmer	82.90
LED-DIMCON-WH	Manual Rotary Dimmer, White	51.56
LED-DIMCON-BL	Manual Rotary Dimmer, Black	51.56
MALEAMP	Amp Connector	12.03
LED-SMPTD4	Inline Touch Dimmer	56.89
LED-SMPADP-60	24" Rectangular Adaptor	7.29
LED-SMPADP-120	48" Rectangular Adaptor	9.31
LED-OVLTD-NI	Dimmer Control, Nickel	45.33
LED-OVLDS-NI	Door Sensor, Nickel	44.94
LED-OVLMS-NI	Motion Sensor, Nickel	49.89



LED POCKET LIGHTS

1.5W POKKIT PLUS LED LIGHTS



The Pockit PLUS has a slim metal body with a 2" light face and throws a wide, 90° angle of bright LED light. 25,000 hour life.

Clean lines, designed for quick recess or surface mounting. Requires only 1/4" depth for recess mounting and 3/8" height for surface. (Mounting Ring provided). The extra PLUS is a bright light without high energy cost and heat.

Requires a 12VDC Power Supply. Pockit PLUS has an attached 2 m (79 in.) Starter Cord.

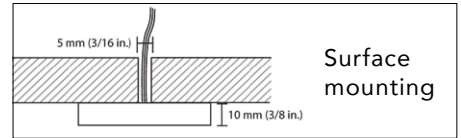
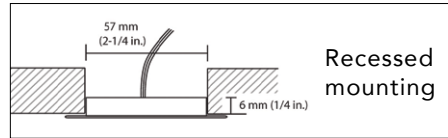

REQUIRED PARTS

1.5W LED POCKET LIGHTS

3000K color temperature.

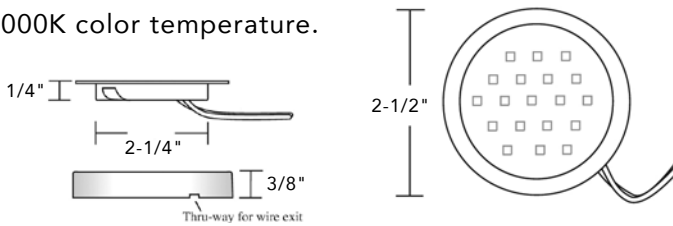

Code	Description	List/ea
POC-1LEDSFR-WNI	Warm White, Nickel	\$ 72.19
POC-1LEDSFR-WBL	Warm White, Black	72.19

Takes any ELT Transformer 6W to 60W.

18W TRANSFORMER: DC-ELT18-CON List \$ 63.05

1.5W - 12 lights max. Includes mounting block and power cord. For an extra 6-snap mounting block order TRANS-MNT-BL). Black.

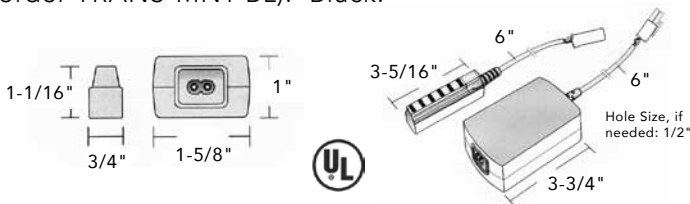

60W TRANSFORMER: DC-ELT60-CON List \$ 74.55

1.5W - 40 lights max. Includes mounting block and power cord. For an extra 6-snap mounting block order TRANS-MNT-BL). Black.

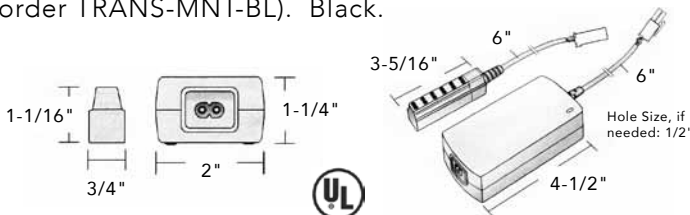

OPTIONAL ACCESSORIES

See Tresco Accessories pages 1020-1025 for further details.

Code	Description	List
TS2-72	Touch On/Off Switch	\$ 50.04
RDSW-2M-WH	Round Switch, White	18.91
RDSW-2M-BL	Round Switch, Black	18.91
TRANS-MNT-BL	6-Snap Mounting Block	11.17
LED-LINKD-25	Extension Cord, 10"	6.19
LED-LINKD-60	Extension Cord, 24"	7.91
LED-LINKD-120	Extension Cord, 48"	8.47
LED-LINKD-180	Extension Cord, 72"	10.31
LED-DIMRMT-12V8A	LED Dedicated Remote Control Dimmer	82.50
LED-DIMRMT-12V8A-U	LED Universal Remote Control Dimmer	82.90
LED-DIMCON-WH	Manual Rotary Dimmer, White	51.56
LED-DIMCON-BL	Manual Rotary Dimmer, Black	51.56
MALEAMP	Amp Connector	12.03
LED-SMPTD4	Inline Touch Dimmer	56.89
LED-SMPADP-60	24" Rectangular Adaptor	7.29
LED-SMPADP-120	48" Rectangular Adaptor	9.31
LED-OVLTD-NI	Dimmer Control, Nickel	45.33
LED-OVLDS-NI	Door Sensor, Nickel	44.94
LED-OVLMS-NI	Motion Sensor, Nickel	49.89



LED PUCK LIGHTS



EQUILINE LED PUCK LIGHTS

12VDC Features

- Dimmable
- 2.5 Watts
- Recess mount
- Surface mount ring (sold separately)
- Avail. in Cool (5000K) and Warm (3000K) White
- 60° Light spread
- 25,000 hour life



REQUIRED PARTS

EQUILINE LED PUCK LIGHTS

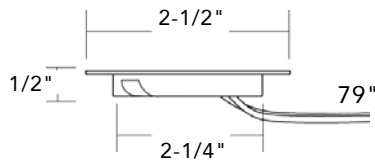
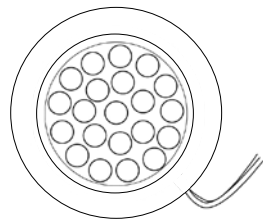

Code	Description	List
POC-2LEDCL-WNI	Warm White, Nickel	\$ 44.48
POC-2LEDCL-WBL	Warm White, Black	44.48
POC-2LEDCL-CNI	Cool White, Nickel	44.48
POC-2LEDCL-CBL	Cool White, Black	44.48

Takes any ELT Transformer 6W to 60W.

REQUIRED PARTS

POWER SUPPLIES

DC-ELT15WP-CON

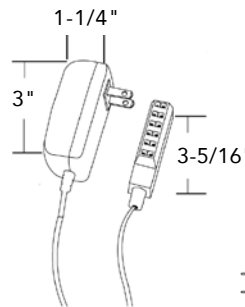

DC-ELT6WP-CON

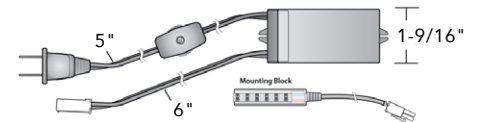
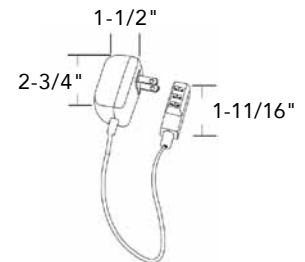

DC-ELT12-CON

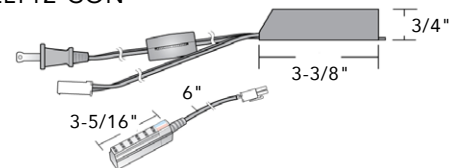

Code	Description	List
DC-ELT6WP-CON	6W 12VDC Wall Mount w/ 3 Snap Block	\$ 30.68
DC-ELT12-CON	12W 12VDC w/ 6 Snap Mounting Block	52.42
DC-ELT15WP-CON	15W 12VDC Wall Mount w/ 6 Snap Mounting Block	39.60

OPTIONAL ACCESSORIES

See Tresco Accessories pages 1020-1025 for further details.

Equiline Puck Surface Ring

Code	Description	List
SMR-2LED-NI	Surface Ring, Nickel	\$ 6.20
SMR-2LED-BL	Surface Ring, Black	6.20

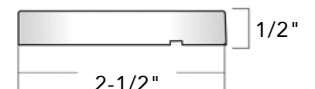



LED POCKET LIGHTS

3W POWER POCKET LED LIGHTS



The Power Pocket LED offers effective flood and task lighting in a low profile, energy-efficient package. Provides rated life of 50,000 hours. Can be used within interior cabinets, under cabinets and store displays - providing a crisp, uniform lighting. Has a frosted diffuser which eliminates glare and reflections.

- Lowest profile - 1/4" depth when recessing
- 1/2" overall thickness (surface mount)
- 120° light spread
- Warm white (3000K)
- 79" cord, dimmer available
- Surface mount ring included
- 2-1/4" hole for recessing

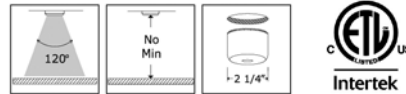

REQUIRED PARTS

3W LED POCKET LIGHTS

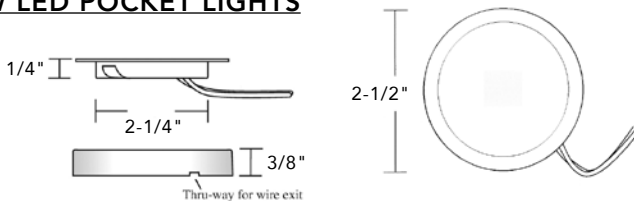

Code	Description	List/ea
POC-3LEDSFR-WWH	WW 3000K, White	\$ 96.25
POC-3LEDSFR-WBL	WW 3000K, Black	96.25
POC-3LEDSFR-WNI	WW 3000K, Nickel	96.25
POC-3LEDSFR-CBL	CW 5000K, Black	96.25
POC-3LEDSFR-CNI	CW 5000K, Nickel	96.25

Takes any ELT Transformer 6W to 60W.

18W TRANSFORMER: DC-ELT18-CON List \$ 63.05

3W - 6 lights max. Includes mounting block and power cord. For an extra 6-snap mounting block order TRANS-MNT-BL). Black.

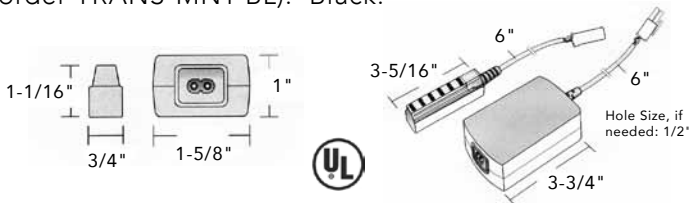

60W TRANSFORMER: DC-ELT60-CON List \$ 74.55

3W - 20 lights max. Includes mounting block and power cord. For an extra 6-snap mounting block order TRANS-MNT-BL). Black.

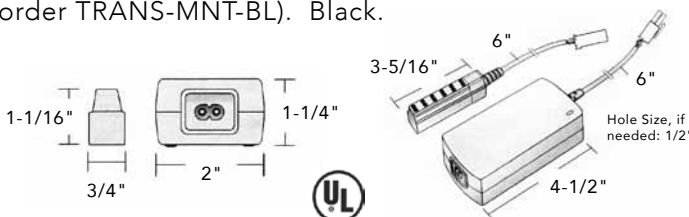

OPTIONAL ACCESSORIES

See Tresco Accessories pages 1020-1025 for further details.

Code	Description	List
TS2-72	Touch On/Off Switch	\$ 50.04
RDSW-2M-WH	Round Switch, White	18.91
RDSW-2M-BL	Round Switch, Black	18.91
TRANS-MNT-BL	6-Snap Mounting Block	11.17
LED-LINKD-25	Extension Cord, 10"	6.19
LED-LINKD-60	Extension Cord, 24"	7.91
LED-LINKD-120	Extension Cord, 48"	8.47
LED-LINKD-180	Extension Cord, 72"	10.31
LED-DIMRMT-12V8A	LED Dedicated Remote Control Dimmer	82.50
LED-DIMRMT-12V8A-U	LED Universal Remote Control Dimmer	82.90
LED-DIMCON-WH	Manual Rotary Dimmer, White	51.56
LED-DIMCON-BL	Manual Rotary Dimmer, Black	51.56
MALEAMP	Amp Connector	12.03
LED-SMPTD4	Inline Touch Dimmer	56.89
LED-SMPADP-60	24" Rectangular Adaptor	7.29
LED-SMPADP-120	48" Rectangular Adaptor	9.31
LED-OVLTD-NI	Dimmer Control, Nickel	45.33
LED-OVLDS-NI	Door Sensor, Nickel	44.94
LED-OVLMS-NI	Motion Sensor, Nickel	49.89



LED POCKET LIGHTS



3W POKKIT T2 LED LIGHTS



The Pockit T2 LED is a true plug-and-play lighting solution. Can be recessed or surface mounted. 120V - no transformer required.

- 120V - No Transformer Needed - Line Voltage
- LED burns cooler
- Linkable up to 10 fixtures
- Brighter and more efficient than Halogen and Xenon
- Surface or Recess mount
- Frosted diffuser



120 NL - Non-Linkable



120 L - Linkable

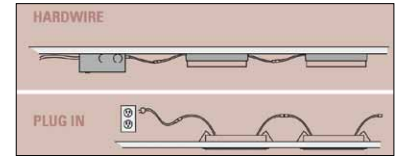
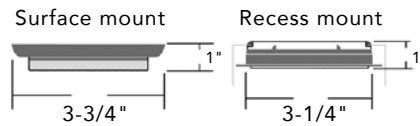

REQUIRED

3W LED POCKET LIGHTS

Warm White 2700K

Input and output leads are 9"

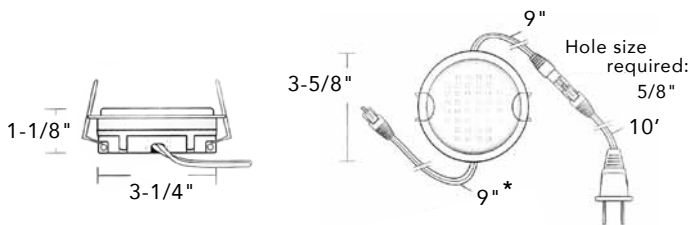

* Minus this cord spec for Non-Linkable

OPTIONAL ACCESSORIES

See Tresco Accessories pages 1020-1025 for further details.

Code	Description	List
TS2-72	Touch On/Off Switch	\$ 50.04
RDSW-2M-WH	Round Switch, White	18.91
RDSW-2M-BL	Round Switch, Black	18.91
HWB-BL-T5	Black Hardwire Box, w/o switch	17.19
HWB-WH-T5	White Hardwire Box, w/o switch	17.24
FPOC-HWB-ADP-WH	Adaptor for Hardwire Box	3.79
FPOC-LINKA-25-BL	10" Black Linking Cord	3.95
FPOC-LINKA-60-BL	24" Black Linking Cord	4.95
FPOC-LINKA-120-BL	48" Black Linking Cord	7.12
FPOC-LINKA-180-BL	72" Black Linking Cord	8.91

Code	Description	List
LPOC-3W-120L-WBL	Linkable, Black	\$ 79.92
LPOC-3W-120L-WNI	Linkable, Nickel	79.92
LPOC-3W-120NL-WBL	Non-Linkable, Black	79.92
LPOC-3W-120NL-WNI	Non-Linkable, Nickel	79.92



FLEXTAPE LED LIGHTS



Warm White LED FlexTape

FLEXTAPE LED LIGHTS - Tresco

- Avg. rated life: 25,000 hrs
- 1.5 Watts / foot
- Sold by 4' and 20' rolls (L x 3/8" W x 1/16" H)
- Cuttable every 49mm (2 inches)
- Low heat
- Strong 3M adhesive backing
- Dimmer available
- Avail. in Warm & Cool White
- Linkable

This flexible LED tape's low profile allows use in many discreet locations. It has an adhesive backing for easy mounting. Sold per roll.

Applications: Cove lighting, Back lighting, Accent and Edge lighting, Toekick, Soffit

REQUIRED PARTS

FLEXTAPE LED

Roll Size 20' or 4'.
Cuttable every 2".



Code	Description	List
LED-FLXTPE-WROLL	Warm White, 20'	\$ 394.29
LED-FLXTPE-4	Warm White, 4'	131.43
LED-FLXTPE-CROLL	Cool White, 20'	424.62
LED-FLXTPE-C4	Cool White, 4'	132.88

TRANSFORMER - 60W

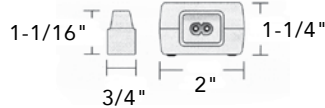
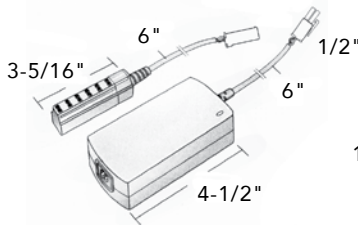

Maximum run of FlexTape from a single Transformer is 40 ft. Mounting Block and Power Cord are included with each Transformer. Black.

Code	Description	List
DC-ELT60-CON	60W 12VDC Transformer	\$ 74.55

STARTER CORD

Straight Feed

Connects each FlexTape segment to mounting block of transformer. Length: 79".



Code	Description	List
LED-TPEPKT-2M	Straight Feed	\$ 8.94
LED-TPEPKT-2M-TEE	Split Feed	14.16

OPTIONAL ACCESSORIES

See Tresco Accessories pages 1020-1025 for further details.

Code	Description	List
TS2-72	Touch On/Off Switch	\$ 50.04
RDSW-2M-WH	Round Switch, White	18.91
RDSW-2M-BL	Round Switch, Black	18.91
LED-TPEPKT-2M-TEE	Split Feed Starter Cord	14.16
LED-DIMRMT-12V8A	LED Dedicated Remote Control Dimmer	82.50
LED-DIMRMT-12V8A-U	LED Universal Remote Control Dimmer	82.90
LED-DIMCON-WH	Manual Rotary Dimmer, White	51.56
LED-DIMCON-BL	Manual Rotary Dimmer, Black	51.56
MALEAMP	Amp Connector	12.03
LED-TPELNK-TEE	Tee Connector	5.83
LED-TPELNK-CON90	Right Angle Connector	5.15
LED-TPELNK-5	Jumper Cord, 2"	5.34
LED-TPELNK-15	Jumper Cord, 6"	5.83
LED-TPELNK-25	Jumper Cord, 10"	6.56
LED-TPELNK-60	Jumper Cord, 24"	7.40
LED-TPELNK-120	Jumper Cord, 48"	7.76
LED-TPELNK-180	Jumper Cord, 72"	8.40
LED-LINKD-25	Extension Cord, 10"	6.19
LED-LINKD-60	Extension Cord, 24"	7.91
LED-LINKD-120	Extension Cord, 48"	8.47
LED-LINKD-180	Extension Cord, 72"	10.31
LED-SMPADP-60	24" Rectangular Adaptor	7.29
LED-SMPADP-120	48" Rectangular Adaptor	9.31
LED-OVLTD-NI	Dimmer Control, Nickel	45.33
LED-OVLDS-NI	Door Sensor, Nickel	44.94
LED-OVLMS-NI	Motion Sensor, Nickel	49.89

10



LED LIGHTING STRIPS



LED LIGHT STRIPS - Tresco ilo L Series

Compact linkable fixture provides economical lighting. The built-in diffuser creates a soft even glow for highlighting every application. Perfect for interior cabinets, toe kicks, coves, wine racks, glass cabinets and more.

- Instant On/Instant Brightness
- Built-In diffuser to reduce glare
- 2.5 Watts per foot
- Aluminum finish
- Linkable up to 12' continuous run (24' total per transformer)
- Available in 6 lengths
- 90° viewing area
- 25,000 hour life
- 2700K color temp
- Dimmer available

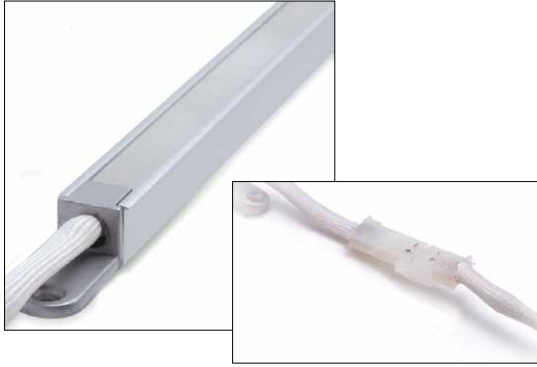

REQUIRED PARTS

LED LIGHTING STRIPS

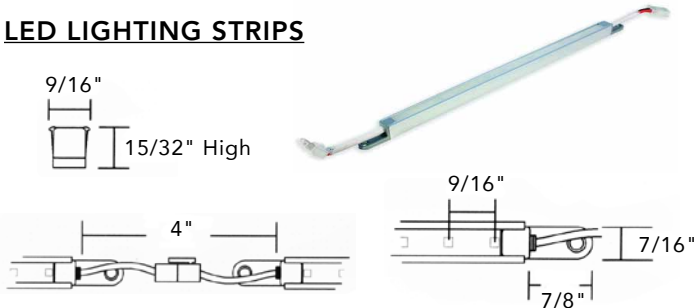

Linkable lighting strips. Warm 2700K.

Code	Length	List/ea
LED-LSP-250WNI	10"	\$ 85.05
LED-LSP-406WNI	16"	116.63
LED-LSP-559WNI	22"	152.65
LED-LSP-711WNI	28"	186.79
LED-LSP-864WNI	34"	231.37
LED-LSP-1016WNI	40"	265.51

TRANSFORMER - 60W

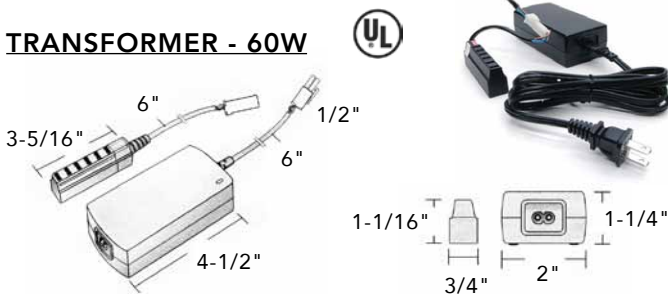

Dimmable on trailing edge (12V side). Mounting Block and Power Cord are included with each Transformer. Black.

Code	Description	List
DC-ELT60-CON	60W 12VDC Transformer	\$ 74.55

REQUIRED PARTS

STARTER/LINK

Required to connect run of lights to transformer.



Code	Length	List/ea
LED-LINKD-25	10"	\$ 6.19
LED-LINKD-60	24"	7.91
LED-LINKD-120	48"	8.47
LED-LINKD-180	72"	10.31

OPTIONAL ACCESSORIES

See Tresco Accessories pages 1020-1025 for further details.

Code	Description	List
TS2-72	Touch On/Off Switch	\$ 50.04
RDSW-2M-WH	Round Switch, White	18.91
RDSW-2M-BL	Round Switch, Black	18.91
LED-DIMRMT-12V8A	LED Dedicated Remote Control Dimmer	82.50
LED-DIMRMT-12V8A-U	LED Universal Remote Control Dimmer	82.90
LED-DIMCON-WH	Manual Rotary Dimmer, White	51.56
LED-DIMCON-BL	Manual Rotary Dimmer, Black	51.56
MALEAMP	Amp Connector	12.03
LED-SMPTD4	Inline Touch Dimmer	56.89
LED-SMPADP-60	24" Rectangular Adaptor	7.29
LED-SMPADP-120	48" Rectangular Adaptor	9.31
LED-OVLTD-NI	Dimmer Control, Nickel	45.33
LED-OVLDS-NI	Door Sensor, Nickel	44.94
LED-OVLMS-NI	Motion Sensor, Nickel	49.89



LED STICK LIGHTS

FINELINE LED STICK LIGHTS



The low-profile FineLine features a frosted diffuser for even illumination. Requires a 60W 12VDC Tresco Power Supply (DC-ELT60-CON).

LED-STK is available in 3 lengths. Warm White, 3000K Color Temp. Installation is a snap, with six Link Cord sizes, direct fixture-to-fixture linking capability and simple U Clip mounting. Includes 79" Starter Cord and two mounting clips with screws.

An optional Inline Touch Dimmer attaches directly or remotely via link cord to the light and features four dimming levels (lo-med-hi-off).



Can link together light to light without a link cord.



79" Starter Cord
Two Mounting Clips w/screws

Link Cords available in 6 lengths.



REQUIRED PARTS

FINELINE LED STICK LIGHTS

Warm White, 3000K

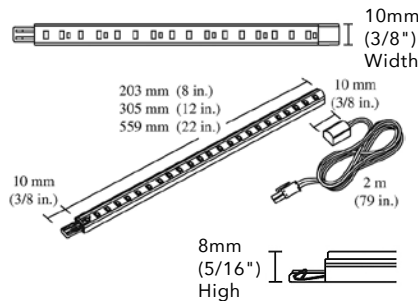

Aluminum/
Nickel Finish

Code	Description	List
LED-STK8-WNI	8" LED Single Stick	\$ 62.90
LED-STK12-WNI	12" LED Single Stick	79.58
LED-STK22-WNI	22" LED Single Stick	140.93

TRANSFORMER - 60W

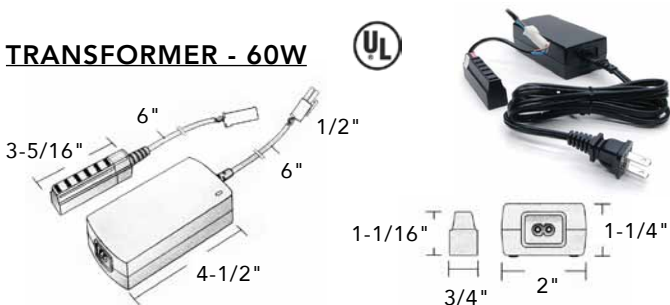

Max 24' per 60W Power Supply. Mounting Block and Power Cord are included with each Transformer. Black.

Code	Description	List
DC-ELT60-CON	60W 12VDC Transformer	\$ 74.55

OPTIONAL ACCESSORIES

See Tresco Accessories pages 1020-1025 for further details.

Code	Description	List
TS2-72	Touch On/Off Switch	\$ 50.04
RDSW-2M-WH	Round Switch, White	18.91
RDSW-2M-BL	Round Switch, Black	18.91
TRANS-MNT-BL	6-Snap Mounting Block	11.17
LED-DIMRMT-12V8A	LED Dedicated Remote Control Dimmer	82.50
LED-DIMRMT-12V8A-U	LED Universal Remote Control Dimmer	82.90
LED-DIMCON-WH	Manual Rotary Dimmer, White	51.56
LED-DIMCON-BL	Manual Rotary Dimmer, Black	51.56
MALEAMP	Amp Connector	12.03
LED-SMPTD4	Inline Touch Dimmer	56.89
LED-SMPADP-60	24" Adaptor Link	7.29
LED-SMPADP-120	48" Adaptor Link	9.31
LED-OVLTD-NI	Dimmer Control, Nickel	45.33
LED-OVLDS-NI	Door Sensor, Nickel	44.94
LED-OVLS-NI	Motion Sensor, Nickel	49.89
LED-STKDIM-TD4	Inline Touch Dimmer	44.69
LED-STKLNK-5	2" Stick Linking Cord	4.30
LED-STKLNK-15	6" Stick Linking Cord	4.81
LED-STKLNK-25	10" Stick Linking Cord	5.16
LED-STKLNK-60	24" Stick Linking Cord	6.36
LED-STKLNK-120	48" Stick Linking Cord	7.91
LED-STKLNK-180	72" Stick Linking Cord	9.62
STKAUCLP-NI	Adjustable U Clip, Nickel	3.01

10

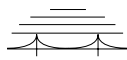

SIMPLED LIGHTS



SIMPLED LIGHT SERIES 4.5W/ft, Dimmable

The SimplLED's very high output (4.5W/foot) comes in 3 lengths, and the fixture quickly mounts with U clips or screws. It can be linked back-to-back with Link Cords that are available in 6 lengths. Dimmer options are also available. Warm White with a Nickel Finish. "Three-in-one" diffuser option packaged with each light: clear, frosted or milk/opal which determines the light's glare/reflection and intensity.

Three DIFFUSER Options (packaged with each light)

Diffuser Options	Eliminate Glare/Reflection	Intensity (Lumen Output)
Clear	No reduction	Best
Frosted	Good	Better
Milk/Opal	Best	Good

With three Diffuser options, you can easily select your preferred lighting output.

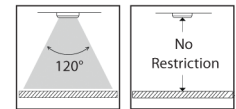

REQUIRED PARTS

SIMPLED LED LIGHTS

Warm White, 3000K

10

LED-SMP in 3 lengths

Aluminum/
Nickel Finish

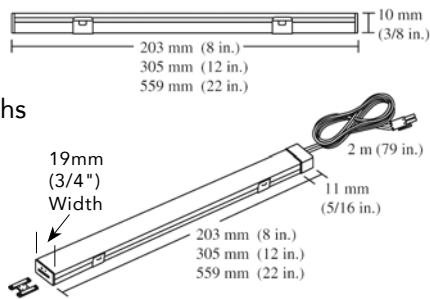

Code	Description	List
LED-SMP8-WNI	SimpLED 8" strip, 3W	\$ 82.67
LED-SMP12-WNI	SimpLED 12" strip, 4.5W	111.21
LED-SMP22-WNI	SimpLED 22" strip, 9W	211.23

TRANSFORMER - 60W

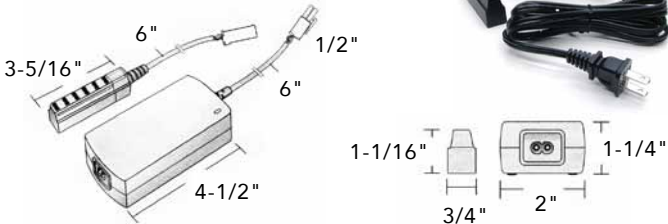

Max 13' per 60W Power Supply. Mounting Block and Power Cord are included with each Transformer. Black.

Code	Description	List
DC-ELT60-CON	60W 12VDC Transformer	\$ 74.55

OPTIONAL ACCESSORIES

See Tresco Accessories pages 1020-1025 for further details.

Code	Description	List
TS2-72	Touch On/Off Switch	\$ 50.04
RDSW-2M-WH	Round Switch, White	18.91
RDSW-2M-BL	Round Switch, Black	18.91
TRANS-MNT-BL	6-Snap Mounting Block	11.17
LED-DIMRMT-12V8A	LED Dedicated Remote Control Dimmer	82.50
LED-DIMRMT-12V8A-U	LED Universal Remote Control Dimmer	82.90
LED-SMPTD4	Inline Touch Dimmer	56.89
LED-SMPADP-60	24" Adaptor Link	7.29
LED-SMPADP-120	48" Adaptor Link	9.31
LED-OVLTD-NI	Dimmer Control, Nickel	45.33
LED-OVLDS-NI	Door Sensor, Nickel	44.94
LED-OVLMS-NI	Motion Sensor, Nickel	49.89
LED-SMPLNK-5	Linking Cord, 2"	5.50
LED-SMPLNK-15	Linking Cord, 6"	5.84
LED-SMPLNK-25	Linking Cord, 10"	6.36
LED-SMPLNK-60	Linking Cord, 24"	7.39
LED-SMPLNK-120	Linking Cord, 48"	9.11
LED-SMPLNK-180	Linking Cord, 72"	11.00
LED-LINKD-25	Extension Cord, 10"	6.19
LED-LINKD-60	Extension Cord, 24"	7.91
LED-LINKD-120	Extension Cord, 48"	8.47
LED-LINKD-180	Extension Cord, 72"	10.31
SMPAUCLP-NI	Adjustable U-Clip, Nickel	3.01



EUROLINX

EUROLINX LINEAR LIGHTING

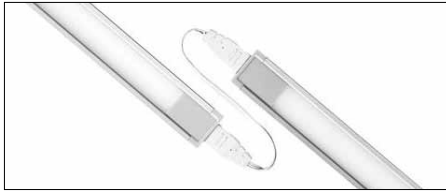

EUL - Eurolinx linkable lighting

The Eurolinx flat profile blends in with any application. Using specialized diffuser and reflector technology to achieve Uniform output, this European styled light is a perfect choice for all contemporary and high-end commercial applications. Use the magnets within the U-Clips for metal shelving or office furniture mounting. Features two beam spreads based on orientation of lights. 4W per foot and over 200 lumens.

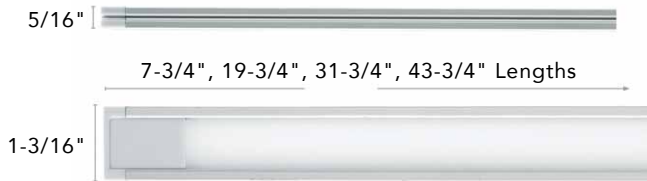

- Available in four lengths
- Linkable back-to-back up to 10' (3 m) continuous run
- Mounting clips with integrated magnets allow for metal surface mounting as well as traditional screw mount
- Optional in-line Gradual Touch Dimmer
- Sleek, contemporary European design

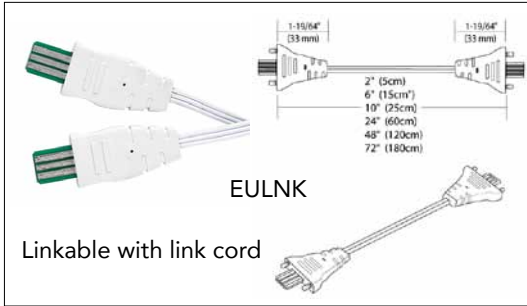

Linkable with link cord

EULNK

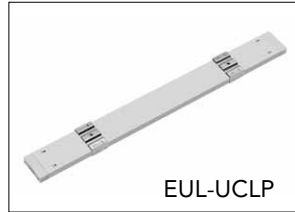

EUL-UCLP

Mounting clips with integrated magnets



EUL-GTD

Optional inline gradual touch dimmer



EUL-BTB-GY

Back-to-Back Link

10

Required Items

Eurolinx Series 12VDC. Each light contains: 79" cord, U-Clips and a back to back connector

Code	Description	List/ea
EUL3W-197CAL	7.75", 3W, Cool White	\$ 93.76
EUL3W-197WAL	7.75", 3W, Warm White	93.76
EUL7W-502CAL	19.75", 7W, Cool White	121.21
EUL7W-502WAL	19.75", 7W, Warm White	121.21
EUL11W-806CAL	31.75", 11W, Cool White	151.11
EUL11W-806WAL	31.75", 11W, Warm White	151.11

18W TRANSFORMER: DC-ELT18-CON List \$ 63.05

60W TRANSFORMER: DC-ELT60-CON List \$ 74.55

Includes mounting block and power cord. For an extra 6-snap mounting block order TRANS-MNT-BL. Maximum 15 feet per 60W power supply.

Two Beam Spreads!!!

Powered Left Side Powered Right Side

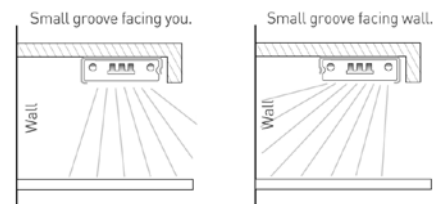

Scan for more info

Optional Items

Code	Description	List/ea
EULNK-15-WH	6" Link Cord, white	\$ 9.85
EULNK-25-WH	10" Link Cord, white	10.38
EULNK-60-WH	24" Link Cord, white	11.96
EULNK-120-WH	48" Link Cord, white	14.24
EULNK-180-WH	72" Link Cord, white	16.88
EULNK-BTB-GY	Back-to-back Link, gray	5.45
EUL-GTD	27W gradual inline touch dimmer	29.20
EUL-UCLP	U-Clip pack (2 clips)	6.68



TRESCENT LEDS



T5 TRESCENT LED SERIES



- Stocking Warm/Cool Temps and Black/Nickel finishes
- Avail. in 4 lengths
- Instant On, Instant Brightness
- No hum or flicker
- 30,000 hr life
- 6' Starter cord included
- 6 lengths of linking cords
- Optional Hardwire Box avail.

Line Voltage - No transformer/power supply needed.

T5 TRESCENT LED SERIES

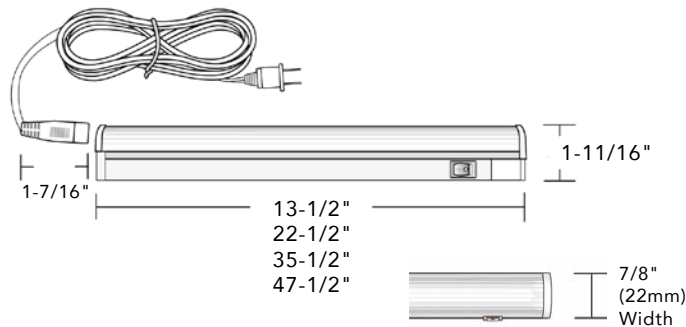

OPTIONAL ACCESSORIES

See Tresco Accessories pages 1020-1025 for further details.

Code	Description	List/ea
T54W-343-WWH	4W WW, White 13.5"	\$ 63.52
T54W-343-CWH	4W CW, White 13.5"	63.52
T54W-343-WBL	4W WW, Black 13.5"	63.52
T54W-343-CBL	4W CW, Black 13.5"	63.52
T57W-571-WWH	7W WW White 22.5"	93.42
T57W-571-CWH	7W CW White 22.5"	93.42
T57W-571-WBL	7W WW Black 22.5"	93.42
T57W-571-CBL	7W CW Black 22.5"	93.42
T514W-904-WWH	14W WW, White 35.5"	162.25
T514W-904-CWH	14W CW, White 35.5"	162.25
T514W-904-WBL	14W WW, Black 35.5"	162.25
T514W-904-CBL	14W CW, Black 35.5"	162.25
T518W-1204-WWH	18W WW, White 47.5"	209.31
T518W-1204-CWH	18W CW, White 47.5"	209.31
T518W-1204-WBL	18W WW, Black 47.5"	209.31
T518W-1204-CBL	18W CW, Black 47.5"	209.31

Code	Description	List/ea
T5-LNK15-WH	6" White Linking Cord	\$ 5.31
T5-LNK15-BL	6" Black Linking Cord	5.31
T5-LNK25-WH	10" White Linking Cord	6.37
T5-LNK25-BL	10" Black Linking Cord	6.37
T5-LNK60-WH	24" White Linking Cord	7.08
T5-LNK60-BL	24" Black Linking Cord	7.08
T5-LNK120-WH	48" White Linking Cord	7.78
T5-LNK120-BL	48" Black Linking Cord	7.78
T5-LNK180-WH	72" White Linking Cord	8.49
T5-LNK180-BL	72" Black Linking Cord	8.49
HWB-WH-T5	White LED Hardwire Box	17.24
HWB-BL-T5	Black LED Hardwire Box	17.19
T5-HWBADP-WH	Adapter cord for White LED Hardwire Box	3.44
T5-HWBADP-BL	Adapter cord for Black LED Hardwire Box	3.44



LED ACCESSORIES

LED POWER SUPPLIES

TRANSFORMERS - 12W, 18W, 60W

12V DC Power Supply, equipped with mounting block that allows for 6 easy snap-in connections. Supplied with a standard 6' 110/120V cord and plug.



DC-ELT12-CON

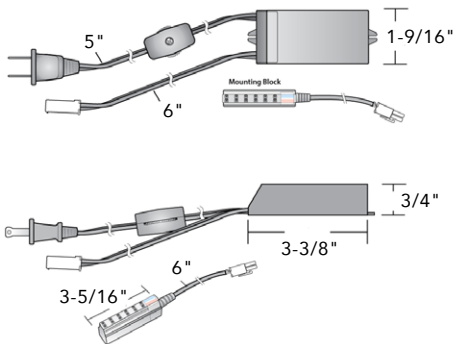

DC-ELT18-CON

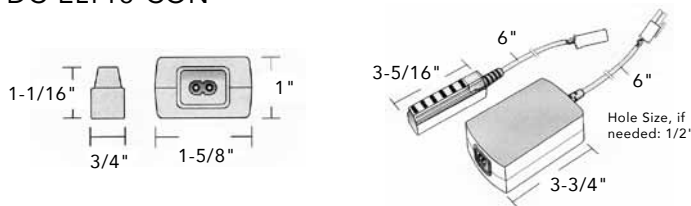

DC-ELT60-CON

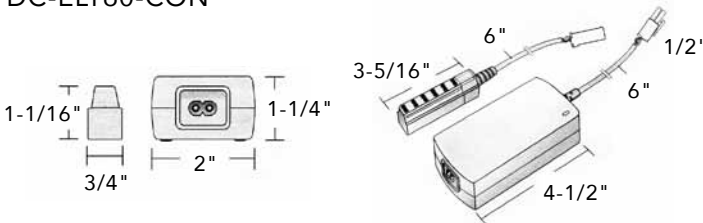

Code	Description	List
DC-ELT12-CON	12W 12VDC Transformer	\$ 52.42
DC-ELT18-CON	18W 12VDC Transformer	63.05
DC-ELT60-CON	60W 12VDC Transformer	74.55

LED WALL MOUNT POWER SUPPLIES

12V DC Wall Mount Power Supplies for Equiline Puck Lights. 6W includes 3 Snap Mounting Block, 15W includes a 6 Snap Mounting Block.



DC-ELT6WP-CON

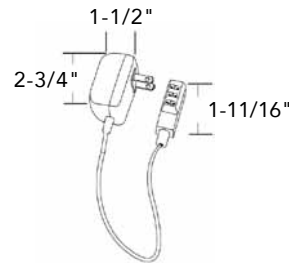

DC-ELT15WP-CON

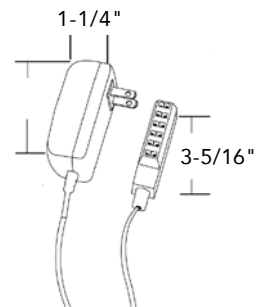

Code	Description	List
DC-ELT6WP-CON	6W 12VDC Wall Mount w/ 3 Snap Block	\$ 30.68
DC-ELT15WP-CON	15W 12VDC Wall Mount w/ 6 Snap Mounting Block	39.60

ELECTRONIC TRANSFORMER - 60W
For Xenon Lights

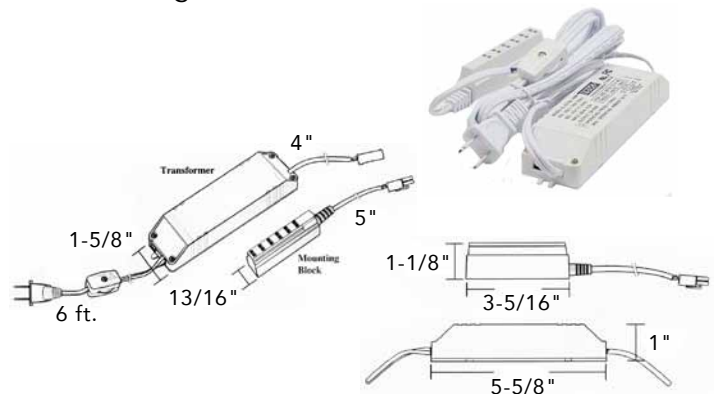

60W Transformer. Power cord with roll switch. Snap block with male/female connectors. Short circuit and overload protected with auto reset. RF1 protection.

Code	Description	List/ea
SL-ELT60-CON	12VAC, 60W, White	\$ 58.44

LED ACCESSORIES



HARDWIRE 12V DC POWER SUPPLY

Dimmable

- 60W 12V DC
- Magnetic transformer
- cETLus listed
- Class 2 w/ manual reset circuit breaker on secondary
- No minimum load requirement*
- Dimmable by standard LED/CF Wall dimmers
- Works with all Tresco 12V DC Dimmable light fixtures
- 2-1/4" H x 6" L x 2-5/8" W



DC-MGT60-CON



Hardwire within unit

* No minimum load when controlled by a dimmer

Code	Description	List/ea
DC-MGT60-CON	Dimmable Hardwire Power Supply	\$ 264.51

LUTRON DIVA C-L DIMMER

Works with above LED Power Supply

- Matches existing switches
- Large paddle switch and a small slider
- Slide control to adjust lights, paddle switch returns light to your favorite level
- Power failure memory
- Standard RFI suppression
- Rated at 120 VAC, 60 Hz
- Use only with dimmable bulbs



Wall Dimmer



DVCL-153PH-WH	List \$ 74.82
---------------	---------------

MOUNTING BLOCK

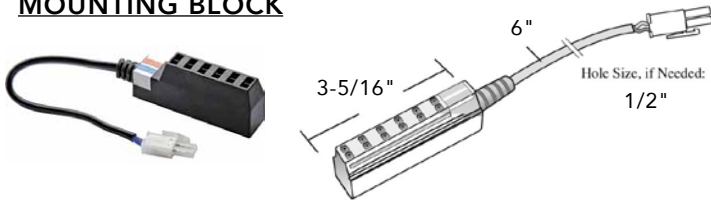

6 Snap Mounting Block. For Tresco DC Power Supplies only, 60W max. Add an extra mounting block to utilize the full capacity of the power supply. Can be hardwired on above Hardwire Power Supply.

Code	Description	List/ea
TRANS-MNT-BL	6-Snap Mounting Block	11.17

TOUCH ON/OFF SWITCH

On/Off switch touch pad attaches to surface with adhesive backing. Power supply plugs into On/Off switch.

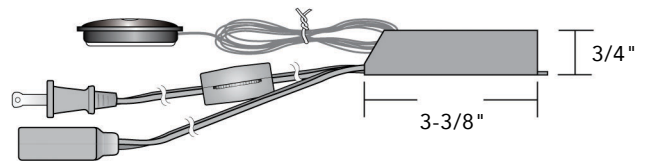
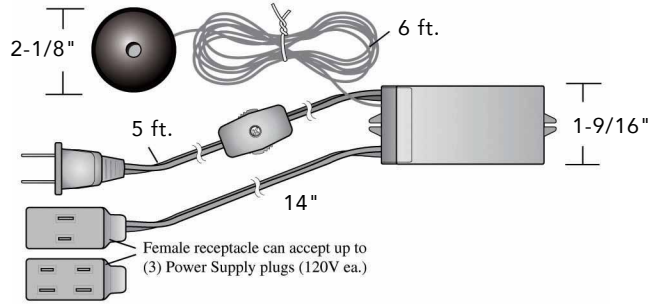

Code	Description	List/ea
TS2-72	Touch On/Off Switch	50.04

ROUND SWITCH - 12V

Round Rocker Switch available in Black or White. 3/4" hole required for switch. 79" cord from switch to plug.

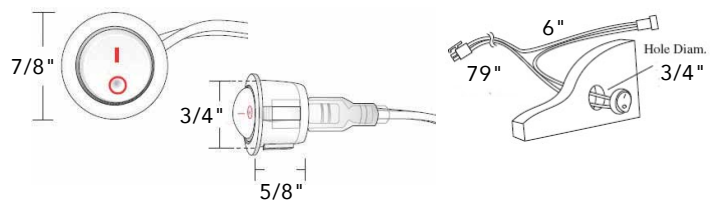

Code	Description	List/ea
RDSW-2M-WH	Round Switch, White	\$ 18.91
RDSW-2M-BL	Round Switch, Black	18.91



REMOTE CONTROL LED DIMMERS - 12V

Remote Control LED Dimmers feature radio-frequency, remote-control dimming to adjust lights from anywhere in the room - up to 30 feet. Provides On/Off power and dims lights from 100% to 1%.



The Dedicated Remote Control independently controls one specific dimmer in a room with other dimmers. The Universal Remote Control controls multiple dimmers in a room. 12V DC, 96W.

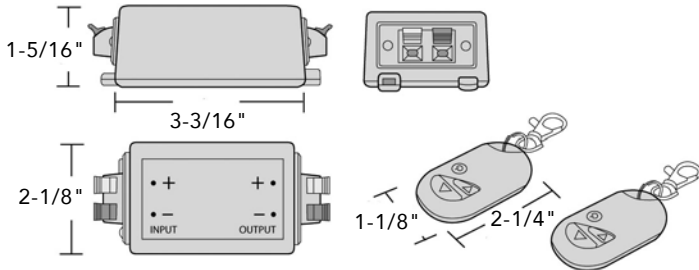

Code	Description	List/ea
LED-DIMRMT-12V8A	LED Dedicated Remote Control Dimmer	\$ 82.50
LED-DIMRMT-12V8A-U	LED Universal Remote Control Dimmer	82.90

AMP CONNECTOR

Male AMP Connector for LED Light Fixtures.



Code	Description	List/ea
MALEAMP	AMP Connector	\$ 12.03

LED ACCESSORIES

MANUAL ROTARY DIMMER

Provides On/Off power and dims lights from 1-100%. Available in Black or White.

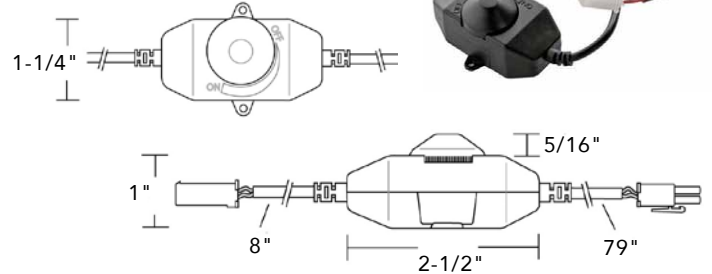

Code	Description	List
LED-DIMCON-WH	Manual Rotary Dimmer, White	\$ 51.56
LED-DIMCON-BL	Manual Rotary Dimmer, Black	51.56

EXTENSION CORD

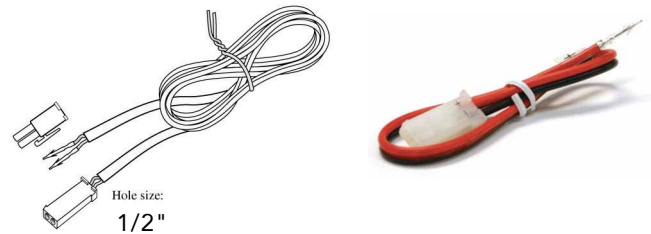

Code	Description	List
LED-LINKD-25	Extension Cord, 10"	\$ 6.19
LED-LINKD-60	Extension Cord, 24"	7.91
LED-LINKD-120	Extension Cord, 48"	8.47
LED-LINKD-180	Extension Cord, 72"	10.31

TEE STARTER CORD

Split feed

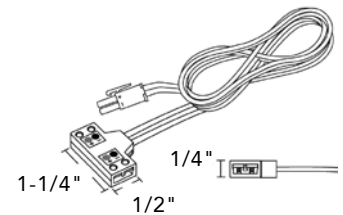

79" Flextape Tee Starter Lead. 5/8" hole required.

Code	List/ea
LED-TPEPKT-2M-TEE	\$ 14.16



LED ACCESSORIES

JUMPER CORD

Link Flextape splices together. Positive and negative contacts on Flextape and FlexConnects should match up, to maintain proper polarity.



Code	Description	List
LED-TPELNK-5	Flextape Link Cord, 2"	\$ 5.34
LED-TPELNK-15	Flextape Link Cord, 6"	5.83
LED-TPELNK-25	Flextape Link Cord, 10"	6.56
LED-TPELNK-60	Flextape Link Cord, 24"	7.40
LED-TPELNK-120	Flextape Link Cord, 48"	7.76
LED-TPELNK-180	Flextape Link Cord, 72"	8.40

ROUND DIMMER/SENSORS

10 Recessed or surface mounted lighting controllers for 12VDC. Can be placed between mounting block and power supply (sold separately) to control all the lights on one system, or between light and mounting block for isolated control of each light. Uses power supplies; DC-ELT12, 18, or 60. Max Wattage: 27W. 17/32" diameter, 2-3/8" Length. Cable input: 79", output: 6". Nickel finish.



LED-OVLTD-NI
Touch ON/OFF and 0-100% dimming control. Hold finger down for dimming.



LED-OVLMS-NI
Turns on when human motion is detected. Sensor range 0-5 ft. 100° viewing. Time on: 30 sec. if no motion.



LED-OVLDS-NI
Door Open: Light on; Door Closed: Light off. Sensor range: 0 - 3-1/8".

Code	Description	List
LED-OVLTD-NI	Dimmer Control	\$ 45.33
LED-OVLMS-NI	Motion Sensor	44.94
LED-OVLDS-NI	Door Sensor	49.89

RECTANGLE DIMMER/ADAPTERS

Inline Touch Dimmer Sensor (4-Step), for use with Tresco LED lighting systems. 12VDC.



2-3/4" L x 3/8" H.

- Control the intensity of light with this 4-Step dimmer (low, medium, high, off)
- Blue indicator light to help locate sensor in the dark
- Max load. 27W

Adapter Cords for use with the Control Modules for Tresco LED lighting systems.



Code	Description	List
LED-SMPTD4	27W Inline Touch Dimmer	\$ 56.89
LED-SMPADP-60	24" 12VDC Adapter	7.29
LED-SMPADP-120	48" 12VDC Adapter	9.31

TEE CONNECTOR

For connecting FlexTape splices at a T-junction.



Code	Description	List
LED-TPELNK-TEE	Tee Connector	\$ 5.83

RIGHT ANGLE CONNECTOR

For connecting FlexTape splices at a 90 degree corner.



Code	Description	List
LED-TPELNK-CON90	Right Angle Connector	\$ 5.15



LED ACCESSORIES

FINELINE TOUCH DIMMER

For FineLine Stick LEDs

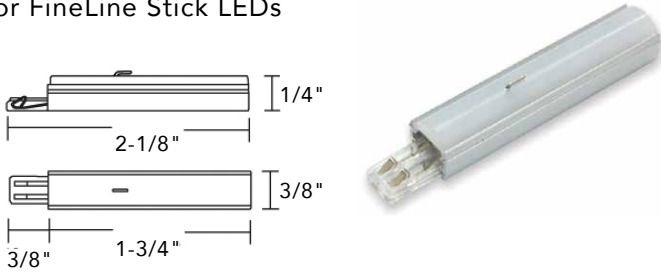

4-Step Dimmer Sensor (low, medium, high, off). Max Load 27W. Controls up to 11 feet of FineLine Lights. Attaches directly or remotely via link cord to the FineLine Lights.

<u>Code</u>	<u>Description</u>	<u>List</u>
LED-STKDIM-TD4	Inline Touch Dimmer	\$ 44.69

FINELINE LINK CORDS

For FineLine Stick LEDs

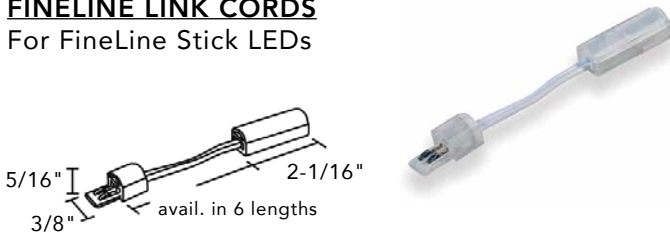

12VDC Stick Linking Cord for use with Tresco Fineline lights. Fineline lights can be mounted end-to-end or with these optional link cords. Available in six lengths. Hole size (if needed): 7/16 in.

<u>Code</u>	<u>Description</u>	<u>List</u>
LED-STKLNK-5	2" Fineline Linking Cord	\$ 4.30
LED-STKLNK-15	6" Fineline Linking Cord	4.81
LED-STKLNK-25	10" Fineline Linking Cord	5.16
LED-STKLNK-60	24" Fineline Linking Cord	6.36
LED-STKLNK-120	48" Fineline Linking Cord	7.91
LED-STKLNK-180	72" Fineline Linking Cord	9.62

SIMPLED LINK CORDS

For SimpleLED Lights

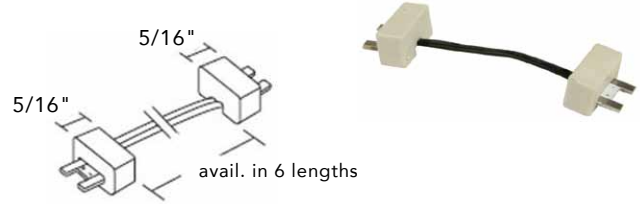

12V DC Linking Cord for use with Tresco SimpleLED lights. SimpleLED lights can be mounted back-to-back or with these optional link cords. Available in six lengths. Hole size (if needed): 7/8 in.

<u>Code</u>	<u>Description</u>	<u>List</u>
LED-SMPLNK-5	2" Simpled Linking Cord	\$ 5.50
LED-SMPLNK-15	6" Simpled Linking Cord	5.84
LED-SMPLNK-25	10" Simpled Linking Cord	6.36
LED-SMPLNK-60	24" Simpled Linking Cord	7.39
LED-SMPLNK-120	48" Simpled Linking Cord	9.11
LED-SMPLNK-180	72" Simpled Linking Cord	11.00

ADJUSTABLE U-CLIPS

Swivel and adjust Fineline Stick and SimpleLED Lighting. Nickel finish.



<u>Code</u>	<u>Description</u>	<u>List</u>
STKAUCLP-NI	Adjustable U-Clip for Fineline Sticks	3.01
SMPAUCLP-NI	Adjustable U-Clip for SimpleLEDs	3.01

10

TRESCO ACCESSORIES



T5 TRESCENT LINK CORDS

For T5 LED Lights



Avail. in Black or White.
Hole size, if needed: 3/4"

For use with Tresco Trescent T5 lights. Allow for easy wiring over and around obstacles without a new power supply.

Code	Description	List/ea
T5-LNK15-WH	6" White Linking Cord	\$ 5.31
T5-LNK15-BL	6" Black Linking Cord	5.31
T5-LNK25-WH	10" White Linking Cord	6.37
T5-LNK25-BL	10" Black Linking Cord	6.37
T5-LNK60-WH	24" White Linking Cord	7.08
T5-LNK60-BL	24" Black Linking Cord	7.08
T5-LNK120-WH	48" White Linking Cord	7.78
T5-LNK120-BL	48" Black Linking Cord	7.78
T5-LNK180-WH	72" White Linking Cord	8.49
T5-LNK180-BL	72" Black Linking Cord	8.49

T5 HARDWARE BOXES/ADAPTER CORDS

Without switch. Available in White and Black. Adapter cord is required for proper connection.

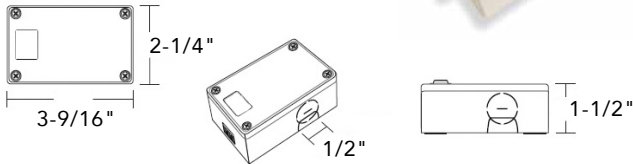

Code	Description	List/ea
HWB-WH-T5	White LED Hardwire Box	\$ 17.24
HWB-BL-T5	Black LED Hardwire Box	17.19
T5-HWBADP-WH	Adapter cord for White LED Hardwire Box	3.44
T5-HWBADP-BL	Adapter cord for Black LED Hardwire Box	3.44

POCKIT T2 ADAPTER

For Hardwire Box

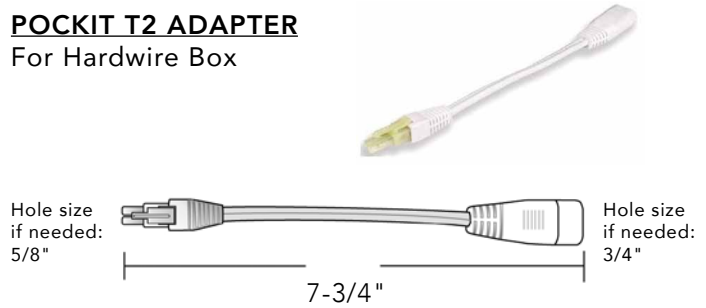

Code	Description	List/ea
FPOC-HWB-ADP-WH	Adapter for Hardwire Box / Pockit T2 Lights	\$ 3.79

POCKIT T2 LINK CORDS

For Pockit T2 LED Lights

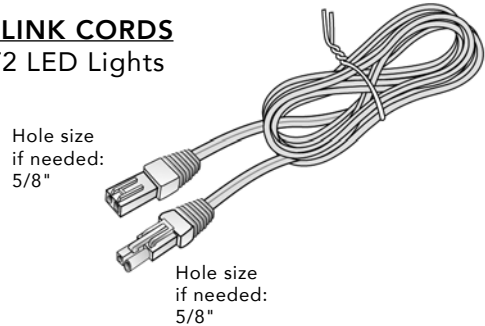

Code	Description	List
FPOC-LINKA-25-BL	10" Black Linking Cord	\$ 3.95
FPOC-LINKA-60-BL	24" Black Linking Cord	4.95
FPOC-LINKA-120-BL	48" Black Linking Cord	7.12
FPOC-LINKA-180-BL	72" Black Linking Cord	8.91

CABLE HOLE COVERS

LARGE PLASTIC CABLE GROMMET

Sugatsune

6-9/16" L x 3" W (overall)

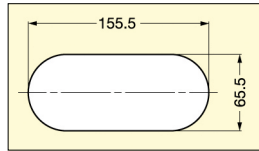

Hole Size

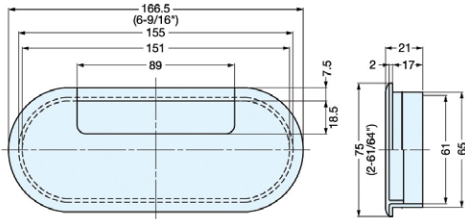

Code	Color	Ctn	List/ea
S165-76W	Off-White	150 ea.	\$ 7.48
S165-76B	Black	150	8.25

WOODEN CABLE HOLE COVERS

Very Slight Oval Top

Bore Size: 1-3/4".
Outside Diameter: 2-3/16"



Code	Wood	Ctn	List/ea
24-OAK	Oak	10 ea.	\$ 3.81
24-BIR	Maple	10	4.16

GROMMETS

HALF MOON GROMMET

With 3 Wire Holes

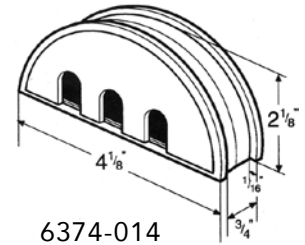

6374-014

Three hole grommet has a fine pebble texture finish. Wire holes are 9/16" x 5/8".

Code	Color	Ctn	List/ea
6374-014	Black	50 ea.	\$ 6.07

LOW PROFILE PAPER GROMMET

1-5/8"W

16-5/8"L



Provides a decorative finish for your computer paper slots. Ultra thin lip (.04") allows this unique grommet to be installed under any type of printer. Insert leg is 1-1/4" deep and has a radius on the inside wall to prevent paper jams. Will accommodate computer paper up to 16" wide and fits into a 1-5/8" x 16-5/8" slot. Install by gluing with a hot melt adhesive and press into place, or staple. High impact polystyrene. Matte black finish.

Code	Color	Ctn	List/ea
122HB-1616-000	Black	10 ea.	\$ 9.91

10



CABLE HOLE COVERS

GROMMETS



1" Hole Grommet

1" Bore, 1-1/8" Overall
Accepts cords up to 13/16"
wide. Plastic.

Code	Color	Ctn	List/ea
1041BK	Black	10 ea.	\$ 2.93
1041BR	Brown	10	2.90
1041WH	White	10	2.93



1-3/4" Hole Grommet

1-3/4" Bore, 2" Overall
Accommodates most telephone
connectors and office machine
plugs. Fits plugs up to 1-5/8".
Plastic.

Code	Color	Ctn	List/ea
1039BK	Black	10 ea.	\$ 2.93
1039BR	Brown	10	2.93
1039WH	White	10	2.93
2000IV*	Ivory	10	2.80
2000PU*	Putty	10	2.97

* disc. when out



2-1/2" Hole Grommet

2-1/2" Bore, 3" Overall
Fits plugs up to 2-1/4", well
suited for most computer uses.

Code	Color	Ctn	List/ea
3000BL	Black	10 ea.	\$ 3.20
1031BR	Brown	10	2.96
1031WH	White	10	2.96
1031GY	Gray	10	2.96
1031AL	Almond	10	2.92



3500 Series Grommet

3-1/4" x 1-3/4" Hole
3-1/2" x 2" Overall
Accepts up to a 3" wide plug.
Openings at both ends - can
handle multiple cords. Plastic.

Code	Color	Ctn	List/ea
3500BL	Black	10 ea.	\$ 8.95
3500BR	Brown	10	2.90
3500GR	Gray	10	3.51
3500WH	White	10	2.90



6000 Liner

6" Hole, 6-3/4" Overall.

Large 6" hole for applications ranging from mass cord
coordination to trash receptacle liners.

Code	Color	Ctn	List/ea
6000BL	Black	10 ea.	\$ 5.82

TRASH CAN RING

Stainless Steel

6" Diameter,
1" and 2" Depths.



Code	Depth	Finish	List/ea
TR6X1.SS	1"	Stainless Steel	\$ 36.97
TR6X2.SS	2"	Stainless Steel	43.98

WIRE ORGANIZATION

WIRE ORGANIZER CHANNELS



Go from this...

to this.

Plastic wire channel is used to store and organize wire and cable on such items as entertainment centers, computer work stations, etc. Black in color with self-adhesive tape. Length: 2.5 meters (98.43").

Code	Ctn	List/ea
CPIWM1500T	36	\$ 24.86

WIRE ORGANIZER CLIPS

Same as above except in 1" strips. Black in color. Projection: 1.09" Each piece has self-adhesive tape.

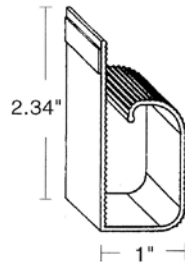

Code	Ctn	List/ea
CPIWM1500C	1000	\$.42

VENT



C816



84126

Economy with high performance, rustproof aluminum, ventilates 44 to 129 square feet. Embossed margin adds rigidity. Revolutionary louver design boosts free area 11% - 17% yet is priced 20% - 40% lower than ordinary undereaves ventilators. No mesh.

Code	Overall Dimensions	Ctn	List/ea
84126	16" x 4"	24	\$ 8.67
C816	16" x 8"	72	4.69

VENTS AND LOUVERS

CABINET VENTILATING LOUVERS

Washington Products

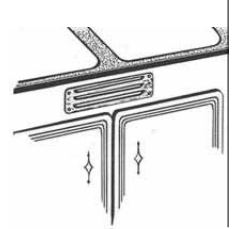

For apron above sink door. Outside dimensions: 10-7/16" x 2-7/8". Cut-Out dimensions: 9" x 2-1/2". 12 per box.

Code	Finish	List/ea
12-26	Bright Chrome	\$ 10.58

MINIATURE VENTS

Under eave mounted attic intake vent. Louvers are stamped and formed, and the screen is securely held in place. Must be used in conjunction with adequate exhaust vents for proper operation. Mill finish. Screen: 10 mil, 8x8 mesh Aluminum Screen.

CV-1, CV-2, CV-3 are packaged 6 units per bag. Order in increments of 6.



CV-4 sold per each.

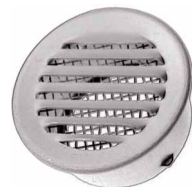

CV-1, CV-2, CV-3
6 ea. per pack,
Full packs only.



CV-4
Bulk - order
per each.

Code	Dia.	Rough Opening	List/ea
CV-1	1-1/4"	1"	\$ 2.81
CV-2	2-1/4"	2"	4.35
CV-3	3-1/2"	3"	4.53
CV-4	4-1/2"	4"	7.46

10