

Fastener Recognition/Tech Sheet

Nominal or Screw Diameter	Threads per inch	Major Diameter	Minor Diameter	Length Range	Min. Torque Lbs./inch
#5 0.125	14	.128/.122	.078/.072	3/8" - 1"	18
#6 0.138	13	.141/.135	.0787/.087	3/8" - 1-1/2"	18
#7 0.151	12	.154/.148	.0874/.096	1/2" - 2"	22
#8 0.164	11	.168/.161	.0937/.1028	1/2" - 3"	28
#9 0.177	10	.181/.174	.0984/.1098	1" - 4"	32
#10 0.190	9	.194/.187	.1098/.1189	5/8" - 6"	39

Flat Heads



Size	Head Diameter		Driver Size
	Max	Min	
#4	.225	.195	1
#5	.252	.220	2R
#6	.255	.240	2R
#7	.295	.267	2
#8	.332	.292	2
#9	.335	.295	2
#10	.385	.340	2

Pan Heads for Framing Screws



Size	Head Diameter		Driver Size
	Max	Min	
#7	Modified	Modified	2R

Truss Heads



Size	Head Diameter		Driver Size
	Max	Min	
#6	.321	.303	2R

Oval Heads



Size	Head Diameter		Driver Size
	Max	Min	
#5	.252	.220	2R
#6	.279	.244	2R

Combo-Truss Heads for Machine Screws



Size	Head Diameter		Driver Size
	Max	Min	
#8	.384	.364	2,2R

Pan Heads



Size	Head Diameter		Driver Size
	Max	Min	
#6	.270	.256	2R
#7	.296	.281	2
#8	.322	.306	2
#9	.373	.357	2

Combo-Round Washer Heads



Size	Head Diameter		Driver Size
	Max	Min	
#8	.321	.303	2R
#9	.471	.376	2
#10	.500	.472	2

Large Round Washer Heads

















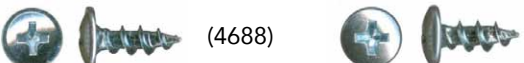

Size	Head Diameter		Driver Size
	Max	Min	
#8	.500	.472	2,2R



SCREW & FASTENER INDEX

Page No.

BUGLE HEAD (Drywall) SCREWS		1810
CABINET CONNECTING SCREWS		1814-1818
CONFIRMAT SCREWS/CAPS/DRILLS		1817
COVER CAPS		1813-1814, 1827
DRAWBOLTS		1835
DRAWERFRONT SCREWS/ADJUSTERS		1819
DRAWERSLIDE SCREWS (Euro guide)	 (6-58FPDT)	1822
DRAWERSLIDE SCREWS (ball-bearing)	 (4688)  (4460)	1821
DRAWERSLIDE SCREWS (undermount)	 (7-58FPDT) use 6-58FPDT, 58-6 PHDT for clips	1822
EURO/SYSTEM SCREWS		1820
FACE FRAME SCREWS		1806
FASTAP SCREWS (Interior/Exterior)		1811-1813
FLAT HEAD WOOD SCREWS (FHWS)		1823
FLAT HEAD TAPPING SCREWS (FHTS)		1824
GRASS WOOD SCREWS		1822
HARDWARE (Machine) SCREWS		1821

SCREW & FASTENER INDEX cont.

Page No.

HEX HEAD SCREWS		1817
KOLBE KORNER		1833
MELAMINE SCREWS		1812
PAN HEAD SCREWS		1824
PARTICLE BOARD SCREWS		1806
NIBBED HEAD SCREWS (self-countersinking)		1807-1808
REAR SOCKET SCREWS		1822
SALICE EURO SCREWS		1820
SPAX SCREWS		1813
SCREW DRIVER TIPS (Pozi, Phillips, Square)		1825-1826
SQUARE DRIVE CABINET MAKER SCREWS		1806, 1808, 1820, 1822
TITUS CONNECTORS		1814-1816
TITUS SCREWS (Hi-Lo)		1814
WHITE INSTALLATION SCREWS		1809
TRIM HEAD STREAKERS		1810
WIC INSTALLATION SCREWS		1809

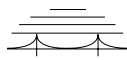

SENCO STAPLES

Note: Dimensions over each staple show leg length.

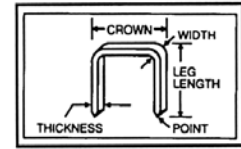

FINE WIRE STAPLES - 3/16" Crown



Crown: 3/16 (4.8)
Width: .030
Thickness: .0215
Gauge: 22



Crown: 3/16 (4.8)
Width: .050
Thickness: .019
Gauge: 20

Use the E10 with KV 255 standards!

Code	Finish	Length	Box Qty	Boxes/Case	List/bx
A08BABP	Galv.	1/2"	30,000	8	\$ 112.00
D10BABPN	Galv.	5/8"	23,000	8	86.68
E08BAA	Galv.	1/2"	10,000	16	49.95
E10BAA	Galv.	5/8"	5,000	25	32.13

MEDIUM WIRE STAPLES

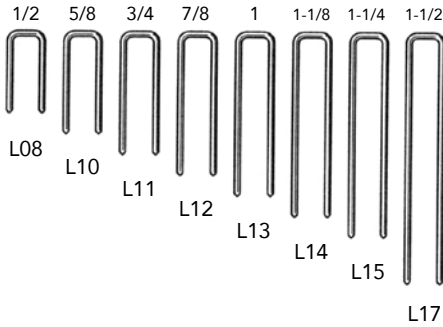

Crown: 1/4 (6.4)
Width: .050
Thickness: .044
Gauge: 18

MEDIUM WIRE STAPLES - 1/4" Crown

L08BAB	Galv.	1/2"	10,000	8	\$ 34.77
L10BABN	Galv.	5/8"	5000	12	22.08
L11BRB	Metallic	3/4"	5000	10	19.10
L12BAB	Galv.	7/8"	5000	10	27.53
L13BRBN	Metallic	1"	5000	8	22.53
L14BRB	Metallic	1-1/8"	5000	6	35.98
L15BRB	Metallic	1-1/4"	5000	6	30.09
L17BAB	Galv.	1-1/2"	6000	6	36.93

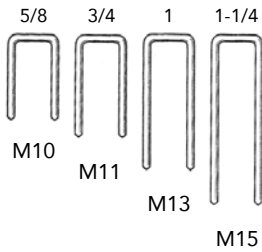

Crown: 3/8 (9.5)
Width: .050
Thickness: .044
Gauge: 18

MEDIUM WIRE STAPLES - 3/8" Crown

M10BRBN	Metallic	5/8"	5000	9	\$ 33.44
M11BRBN	Metallic	3/4"	5000	8	39.19
M13BRB	Metallic	1"	5000	6	43.71
M15BAB	Galv.	1-1/4"	10,000	1	115.55

HEAVY WIRE STAPLES - 7/16" Crown

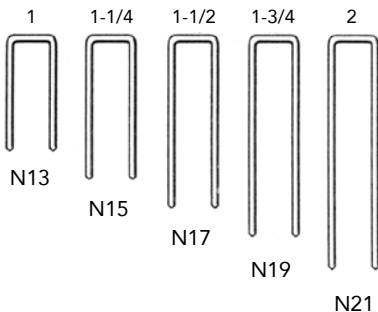

Crown: 7/16 (11.1)
Width: .062
Thickness: .055
Gauge: 16

N13BAB	Galv.	1"	5000	4	\$ 42.54
N15BRB	Metallic	1-1/4"	10,000	1	87.42
N17BRB	Metallic	1-1/2"	10,000	1	88.00
N19BRB	Metallic	1-3/4"	10,000	1	106.75
N21BRB	Metallic	2"	10,000	1	108.65

SENCO BRADS & NAILS

SENCO FINISHING NAILS & BRADS & PINS

15 Ga. 34° Angled Strip Finish Nails

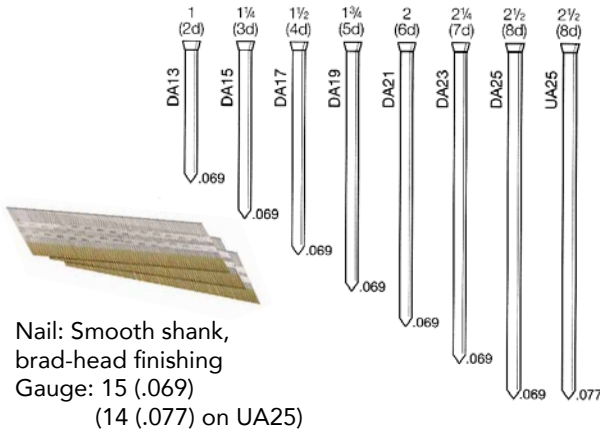

Code	Finish	Length	Qty	Boxes/ Case	List/bx
DA13EPB	Metallic	1"	4000	5	\$ 44.83
DA15EPB	Metallic	1-1/4"	4000	5	46.62
DA17EPB	Metallic	1-1/2"	4000	5	43.06
DA17EABN	Galv.	1-1/2"	4000	5	90.71
DA19EPB	Metallic	1-3/4"	4000	4	55.75
DA21EPB	Metallic	2"	4000	4	56.24
DA21EABN	Galv.	2"	4000	4	81.09
DA23EPB	Metallic	2-1/4"	4000	3	63.57
UA25EPB	Metallic	2-1/2"	3100	3	103.00
DA25EPB	Metallic	2-1/2"	4000	3	60.66
DA25EAB	Galv.	2-1/2"	3000	3	70.60

18 Ga. Straight Strip Brad Nails



AY10	Galv.	5/8"	5000	24	\$ 29.53
AY11	Galv.	3/4"	5000	20	30.98
AY13	Galv.	1"	5000	16	34.41
AX13	Galv.	1"	5000	16	18.20
AX15	Galv.	1-1/4"	5000	12	16.52
AX17	Galv.	1-1/2"	5000	10	18.42
AX18	Galv.	1-5/8"	5000	10	34.34
AX19	Galv.	1-3/4"	5000	5	32.30
A202009	Galv.	2"	800	5	9.64
AX21EAAN	Galv.	2"	5000	6	51.07

**Straight Strip
Micro Pins**

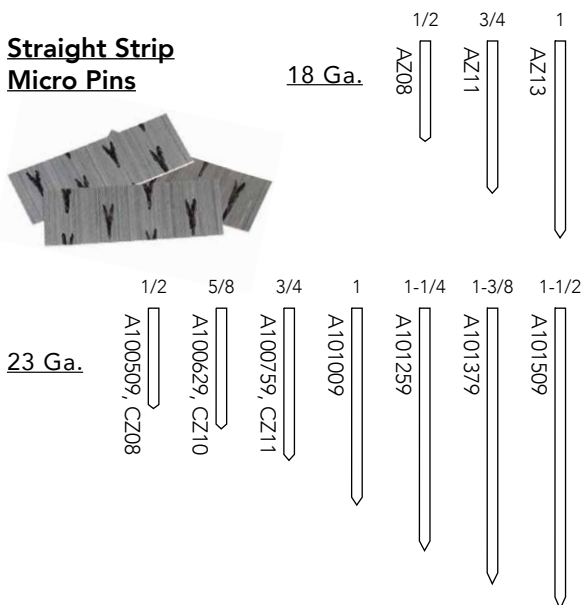

18 Gauge Pins

AZ08EAAN	Galv.	1/2"	5000	32	\$ 29.62
AZ11EAAN	Galv.	3/4"	5000	24	37.58
AZ13EAAN	Galv.	1"	5000	16	33.96

23 Gauge Pins

A100509	Galv.	1/2"	2600	5	\$ 17.38
CZ08EAA	Galv.	1/2"	15500	4	103.94
A100629	Galv.	5/8"	2600	5	16.44
CZ10EAA	Galv.	5/8"	15500	4	107.92
A100759	Galv.	3/4"	2600	5	17.38
CZ11EAA	Galv.	3/4"	15500	4	113.54
A101009	Galv.	1"	2600	5	15.43
A101259	Galv.	1-1/4"	2600	5	16.95
A101379	Galv.	1-3/8"	2600	5	36.28
A101509	Galv.	1-1/2"	2600	5	17.90



GREX TOOLS

Headless Pinners and Pins

23 Gauge Headless Pinner

Pinner

- P635 3/8" - 1-3/8"
- P650 3/8" - 2"



Code	Description	List/ea
P635	3/8" - 1-3/8" Pinner	\$ 372.40
P650	3/8" - 2" Pinner	578.54

Headless Pins / Med Head Brads

P6 Series
23 gauge
Headless pins
10,000/box



GBN Series
18 gauge
Brad Nails
Medium
Head
5,000/box

Code	Description	List/bx
P6/10L	3/8" Headless Pins	\$ 13.70
P6/12L	1/2" Headless Pins	14.10
P6/15L	5/8" Headless Pins	12.06
P6/20L	3/4" Headless Pins	18.65
P6/22L	7/8" Headless Pins	19.33
P6/25L	1" Headless Pins	19.11
P6/28L	1-1/8" Headless Pins	21.81
P6/30L	1-3/16" Headless Pins	23.38
P6/35L	1-3/8" Headless Pins	22.56
P6/38L	1-1/2" Headless Pins	33.16
P6/40L	1-9/16" Headless Pins	36.52
P6/45L	1-3/4" Headless Pins	38.67
P6/50L	2" Headless Pins	45.21
18 GBN18-15	5/8" Brad Nails	22.90
GBN18-25	1" Brad Nails	27.59
GBN18-32	1-1/4" Brad Nails	29.10
GBN18-38	1-1/2" Brad Nails	30.46
GBN18-50	2" Brad Nails	31.23

SENCOR™ CORRUGATED FASTENERS

Senco - For the SC2 Tool



X06NRA - 3/8"



X08NRA - 1/2"



Crown: 1", Thickness: .020", Gauge: 25
Order by the box.

Code	Size	Box Qty	Boxes/ case	List/box
X06NRA	3/8"	5,000	1	\$ 191.22
X08NRA	1/2"	4,000	1	173.91

Senclamp®

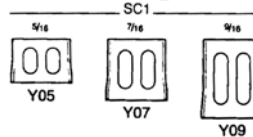

Crown: 7/16" (11.1)
Thickness: .20
Gauge: 25

Y05	Brt. Brass	5/16"	3000	8	\$ 111.95
Y07	Brt. Brass	7/16"	3000	8	123.93
Y09	Brt. Brass	9/16"	3000	6	152.32



SCREWS

FACE FRAME SCREWS

Quickscrews

Pan Head with Type 17 Auger Point for quicker penetration. For hardwoods such as Oak or Maple.

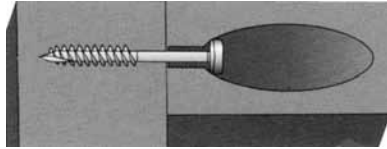

Square Dr.



Phillips Dr.



Square Dr	Size	Ctn	List/M
2722	6 x 1-1/4"	8000	\$ 21.44
2724	6 x 1-1/2"	7000	26.47

Phillips Hd	Size	Ctn	List/M
5715	6 x 1-1/4"	8000	\$ 23.78
5716	6 x 1-1/2"	7000	23.16

"QUICK CUTTER"

FACE FRAME SCREWS

Quickscrews

Square Pan Head Face Frame screws with a double auger point for fast cutting. For easy installation in extremely hard woods, such as hickory.



Code	Size	Ctn	List/M
4082	6 x 1-1/4"	8000	\$ 28.04
5215	6 x 1-1/2"	7000	27.63

FACE FRAME SCREWS - For Particle Board

Quickscrews

A face frame screw with a coarse thread for faster driving and superior holding in softwoods, MDF, and particleboard. Type 17 Auger Point and #2 Square Dr.



Code	Size	Ctn	List/M
4080	7 x 1-1/4"	8000	\$ 24.26
4081	7 x 1-1/2"	7000	26.21

"HI-LOW" POCKET HOLE

FACE FRAME SCREWS

Quickscrews

Plain Steel Finish. #2 Square Drive Head. Hi-Low Thread. Type 17 Auger Pt.



Code	Size	Ctn	List/M
4084	7 x 1-1/4"	8000	\$ 21.34
4085	7 x 1-1/2"	7000	23.84

FACE FRAME SCREWS

Grabber

Pan Head Self-Tapping - for hardwoods. For cabinet assembly and installation. Has a special auger point designed to bore a pilot hole in the hardest wood. Drives faster, eliminates splitting. Black.



PHILLIPS HEAD - Five Pound Boxes

Code	Size	Box	List/bx
V90-4	6 x 1-1/4"	1060	\$ 39.85
V90	6 x 1-1/2"	920	41.85

PHILLIPS HEAD - Bulk Pack

Code	Size	Box	List/M
90S	6 x 1-1/4"	10000	\$ 35.71
90GR	6 x 1-1/2"	5000	38.56

SQUARE DRIVE - Five Pound Boxes

Code	Size	Box	List/bx
V902Q4	6 x 1-1/4"	1105	\$ 39.11
V902Q	6 x 1-1/2"	950	39.11

SQUARE DRIVE - Bulk Pack

Code	Size	Box	List/M
902Q4	6 x 1-1/4"	10000	\$ 37.16
902Q	6 x 1-1/2"	5000	39.60



SCREWS

CABINET ASSEMBLY SCREWS

Quickscrews

Flat head with 4 nibs for self-countersinking. Zinc plated.



<u>Small Pack</u>	<u>Size</u>	<u>Ctn</u>	<u>List/M</u>
1177	1 x 8	1000	\$ 21.36
1178	1-1/4 x 8	1000	26.74
1179	1-1/2 x 8	1000	28.27
1180	1-5/8 x 8	1000	33.99
1181	2 x 8	1000	40.15
1183	2-1/2 x 9	500	57.88
1184	3 x 9	500	66.81

<u>Bulk Pack</u>	<u>Size</u>	<u>Ctn</u>	<u>List/M</u>
136	1 x 8	11000	\$ 18.46
137	1-1/4 x 8	9000	22.17
138	1-1/2 x 8	7000	27.62
139	1-5/8 x 8	5500	28.54
140	2 x 8	4000	34.69
142	2-1/2 x 9	2500	44.20
143	3 x 9	2000	55.89

CABINET ASSEMBLY SCREWS

Type 17 Auger point for quicker penetration. Phillips Flat Head with 4 nibs for self-countersinking. Zinc plated.



<u>Small Pack</u>	<u>Size</u>	<u>Ctn</u>	<u>List/M</u>
9124	1 x 8	1000	\$ 22.80
13404	1-1/8 x 8	1000	25.74
9126	1-1/4 x 8	1000	27.01
9127	1-1/2 x 8	1000	30.38
9128	1-5/8 x 8	1000	36.69
9129	1-3/4 x 8	1000	32.82
9131	2 x 8	1000	43.56
9134	2-1/2 x 9	500	54.15
9135	3 x 9	500	66.26

CABINET ASSEMBLY SCREWS cont.



<u>Bulk Pack</u>	<u>Size</u>	<u>Ctn</u>	<u>List/M</u>
9005SG	1 x 8	11000	\$ 21.27
13362	1-1/8 x 8	10000	22.97
9006SG	1-1/4 x 8	9000	23.63
9007	1-1/2 x 8	7000	27.01
9008	1-5/8 x 8	6000	33.37
9009	1-3/4 x 8	6000	29.94
9010	2 x 8	4000	35.53
9011	2-1/4 x 8	3000	44.41
9012	2-1/2 x 9	2500	53.87
9013	3 x 9	2000	62.59

CABINET ASSEMBLY SCREWS

Type 17 Combo Head

Type 17 Auger point for quicker penetration. Combo Square/Cross recess Flat Head with 4 nibs for self-countersinking. Coarse thread. Zinc plated.



<u>Small Pack</u>	<u>Size</u>	<u>Ctn</u>	<u>List/M</u>
2477	1 x 8	1000	\$ 20.76
2478	1-1/4 x 8	1000	25.18
2482	1-1/2 x 8	1000	29.02
2483	1-5/8 x 8	1000	33.03
2484	2 x 8	1000	37.57
2485	2-1/2 x 9	500	51.78
2486	3 x 9	500	67.92

<u>Bulk Pack</u>	<u>Size</u>	<u>Ctn</u>	<u>List/M</u>
1245	1 x 8	11000	\$ 18.27
1247	1-1/4 x 8	9000	22.04
1250	1-1/2 x 8	7000	25.86
1252	1-5/8 x 8	5500	28.50
1254	2 x 8	4000	34.77
1256	2-1/2 x 9	2500	54.34
1258	3 x 9	2000	67.75



SCREWS

CABINET ASSEMBLY SCREWS

Type 17 #2 Square Drive

Square Drive Flat Head Screws. Four nibs on-head for self counter-sinking and a type 17 auger point for quicker penetration. Zinc in color.

All sizes 1" length and shorter are fully threaded.



Small Pack	Size	Ctn	List/M
12657	1 x 8	1000	\$ 23.25
12658	1-1/4 x 8	1000	26.60
12659	1-1/2 x 8	1000	30.84
12660	1-5/8 x 8	1000	37.29
12661	1-3/4 x 8	1000	37.48
12662	2 x 8	1000	44.59
12664	2-1/2 x 9	500	63.12
12665	3 x 9	500	68.49

Bulk Pack	Size	Ctn	List/M
12613	1 x 8	11000	\$ 18.78
12614	1-1/4 x 8	9000	22.84
12615	1-1/2 x 8	7000	26.28
12616	1-5/8 x 8	5500	31.04
12617	1-3/4 x 8	5500	33.04
12618	2 x 8	4000	37.10
12620	2-1/2 x 9	2500	52.56
12621	3 x 9	2000	57.23

CABINET ASSEMBLY SCREWS

ROUND WASHER HEAD

Type 17 #2 Square Drive

#8 x 1-1/4", Round Washer Head, #2 Square Drive, Coarse Thread, Type 17 Auger Point, Zinc in color.



Code	Size	Ctn	List/M
13292	1-1/4 x 8	9000	\$ 24.73

CABINET ASSEMBLY SCREWS

ROUND WASHER HEAD

Combo Square/Phillips Drive

#8 x 1-1/8", Round Washer Head, Combo Drive #2 Square/Phillips, Coarse Thread, Zinc in color.

Designed for softer woods or particle board.



Code	Size	Ctn	List/M
6468	1-1/8 x 8	9000	\$ 25.98

CABINET ASSEMBLY SCREWS

QUICK CUTTER

Type 17 Phillips Flat Head

For Hardwood Applications

Phillips flat Head with 4 nibs, Double Auger Shank, and Type 17 Auger Point. Minimizes pre-drilling in hardwood applications. Replaces Twinfast-type fasteners. Zinc in color.



Code	Size	Ctn	List/M
7317	1-1/4 x 8	9000	\$ 30.60
7318	1-1/2 x 8	5000	33.24
7319	1-5/8 x 8	5500	37.34
7320	1-3/4 x 8	4000	37.81
7322	2 x 8	4000	44.94
7323	2-1/4 x 8	3000	51.66
7324	2-1/2 x 8	2500	64.46
7325	3 x 8	2000	72.52
7326	3-1/2 x 10	1000	122.50
7327	4 x 10	1000	140.85



SCREWS

CABINET INSTALLATION SCREW

Works in both Wood or Metal Studs

These WI approved installation screws work in wood or metal studs. They have a #3 Phillips Round Washer Head, Hi-Lo thread and a double auger. Zinc in color.



WI Approved



Code	Size	Ctn	List/C
8214	2-1/2 x 14	1500	\$ 16.23
8215	3 x 14	1200	19.05
8216	3-1/2 x 14	1000	30.61
8217	4 x 14	700	33.39

CABINET INSTALLATION SCREW

Round Washer Head

Combo Square Drive and Phillips Head. Zinc Plate or Painted Head: White, Sand or Black. Quick Cutter™ Double Auger.



White



Sand



Black

Zinc



Code	Size	Head	Ctn	List/M
7927	2-1/2 x 10	Zinc	1500	\$ 81.54
7935	3 x 10	Zinc	1500	88.34
7936	3-1/2 x 10	Zinc	1000	113.03
8010SG	2-1/2 x 10	Ptd. White	1500	88.16
8011	3 x 10	Ptd. White	1500	120.45
13794	3 x 10	Sand	1500	126.38
9912	3 x 10	Black	1500	120.51

14 x 3" PAN HEAD SCREW

Quickscrews

These #14 x 3" Phillips Pan Head self-tapping sheet metal screws meet WIC recommendations for cabinet installation on wood or metal studs.



Code	Size	Ctn	List/C
2769	3 x 14	1000	49.59

1809

Dealer No. B/E

QUADREX WHITE POWDER COATED SCREWS

Epoxy coated, Quadrex head

White



White, epoxy-coated Quadrex head screws are deep thread with a pan/washer head. Head size is 3/8" diameter. Drives best with the 2X2QB Quadrex Head screwdriver, though a #2 Square driver (X950-2 Apex for example) will work.

Code	Size	Box	List/bx
8118B	1-1/8" x 8	5000	\$ 248.70
8114B	1-1/4" x 8	5000	192.89
8212	2-1/2" x 8	500	53.04
8212B	2-1/2" x 8	2500	208.19
8300	3" x 8	500	68.90
8300B	3" x 8	2000	232.19

QUADREX SCREWDRIVER BIT

Sqare/Phillip Drive Combo Head



2X2QB



The 2X2QB combo head screwdriver bit has both Square drive and Phillips drive "teeth." This makes it a fine bit to use with the Quadrex white screws as well as the Spax screws.

Code: 2X2QB

List: \$ 5.40 ea.

SCREWS

BUGLE HEAD COARSE SCREW

Grabber



Fastens sheetrock to wood, with superior holding power and ease of penetration. No. 2 Phillips recess. Black.

One Pound Boxes

<u>Code</u>	<u>Size</u>	<u>Box</u>	<u>List/bx</u>
X300	1-1/4 x 6	262	\$ 7.60
X400	1-5/8 x 6	202	7.24
X500	2 x 7	140	7.63
X1100	3 x 8	80	7.63

Five Pound Boxes

<u>Code</u>	<u>Size</u>	<u>Box</u>	<u>List/bx</u>
V100	1 x 6	1580	\$ 31.84
V300	1-1/4 x 6	1315	33.92
V400	1-5/8 x 6	1010	33.56
V500	2 x 7	702	31.96
V1100	3 x 8	400	33.56

Bulk Boxes

<u>Code</u>	<u>Size</u>	<u>Box</u>	<u>List/M</u>
100GR	1 x 6	10000	\$ 14.96
200GR	1-1/8" x 6	10000	15.78
300GR	1-1/4 x 6	8000	17.04
400GR	1-5/8 x 6	5000	21.77
500GR	2 x 7	3500	32.55
900	2-1/2 x 8	2500	44.87
1100GR	3 x 8	2000	56.94

DRYWALL SCREWS

Quickscrews



Phillips Bugle Head, coarse thread screws. Black in color.

<u>Code</u>	<u>Size</u>	<u>Ctn</u>	<u>List/M</u>
9693	4 x 10	1000	\$ 115.10

BUGLE HEAD FINE SCREW

Grabber



For sheetrock and metal studs. Attaches sheetrock to 20-25 gauge steel. Standard bugle head. No. 2 Phillips recess. Black.

Five Pound Boxes

(Approx. count)

<u>Code</u>	<u>Size</u>	<u>Box</u>	<u>List/bx</u>
V968	2-1/2 x 8	475	\$ 31.96
V1168	3 x 8	400	27.32
V1368	4 x 10	235	67.99

Bulk Boxes

<u>Code</u>	<u>Size</u>	<u>Ctn</u>	<u>List/M</u>
968	2-1/2 x 8	2500	\$ 53.14
1168	3 x 8	2000	56.76
1368	4 x 10	1000	141.87

BUGLE HEAD CABINET SCREW

Grabber



For cabinet assembly and installation. No. 2 Phillips recess. Black.

<u>Code</u>	<u>Size</u>	<u>Ctn</u>	<u>List/M</u>
6W	1-1/2 x 7	5000	\$ 40.31

TRIM HEAD STREAKERS

Grabber



Attaches wood trim over single or double layer gypsum board to 20-25 ga. steel. Square Drive. Black.

<u>Code</u>	<u>Size</u>	<u>Ctn</u>	<u>List/M</u>
17S	1-5/8 x 7	10000	\$ 31.10
18S	2-1/4 x 7	5000	47.94
17S76	3 x 8	2000	72.67

Self-Drilling Stalker:

17SD76	3 x 8	2000	84.35
--------	-------	------	-------



FASTAP SCREWS

**FASTAP SELF-DRILLING
CARPENTRY SCREWS**

Tougher Than
Drywall Screws!

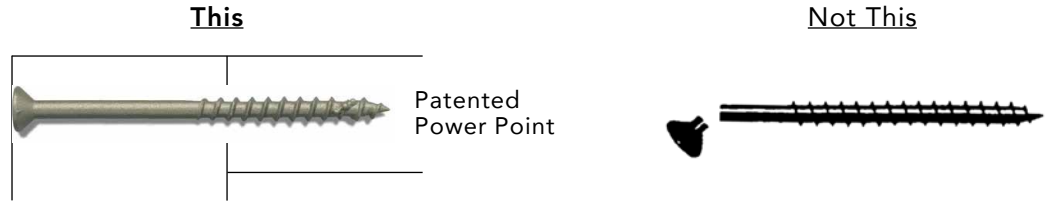

Self-Drilling: Revolutionary Power Point creates a pilot hole as you drive the screw. No pre-drilling needed even in the hardest wood.

45° Threads: Coarse threads with unique 45° angle holds tight for superior pull-out resistance in all woods. Hardened and tempered for greater strength. No need to worry about screws breaking on the job!

Self-Countersinks: Flat head with nibs head design helps resist over-driving and gives you a flush fitting countersink that locks screws tight. Phillips head unless otherwise noted as Square Drive.

SMALL PACKS - FULL CARTONS ONLY

Bugle Head. Black or Unichrome (highly polished zinc).

Order by Box.

Code	Size	Color	Box	List/Box
FTP100	1" x 7	Black	100 ea.	\$ 4.37
FTP100W	"	Black	1000	30.33
FTP100WU	"	Unichr.	1000	30.33
FTP125	1-1/4" x 7	Black.	100	4.61
FTP125W	"	Black	1000	35.18
FTP125WU	"	Unichr.	1000	35.18
FTP125WSQ	" Sq Dr.	Black	1000	35.18
FTP162	1-5/8" x 7	Black	100	5.82
FTP162W	"	Black	1000	43.68
FTP162WU	"	Unichr.	1000	43.68
FTP162WSQ	" Sq Dr.	Black	1000	43.68
FTP200	2" x 7	Black	100	7.28
FTP200W	"	Black	1000	54.59
FTP200WU	"	Unichr.	1000	54.59
FTP200WSQ	" Sq Dr.	Black	1000	54.59
FTP225	2-1/4" x 8	Black	100	9.83
FTP225W	"	Black	500	37.61
FTP225WSQ	" Sq Dr.	Black	500	37.61
FTP250	2-1/2" x 8	Black	100	11.53
FTP250W	"	Black	500	43.68
FTP250WU	"	Unichr.	500	43.68
FTP250WSQ	" Sq Dr.	Black	500	43.68
FTP300	3" x 8	Black	100	13.59
FTP300W	"	Black	500	49.74
FTP300WU	"	Unichr.	500	49.74
FTP300WSQ	" Sq Dr.	Black	500	49.74

BULK PACK - FULL CARTONS ONLY

Bugle Head. Black or Unichrome (highly polished zinc).

Order by Box.

Code	Size	Color	Box	List/Box
FTP100B	1" x 7	Black	10000	\$ 271.75
FTP100BU	"	Unichr.	10000	271.48
FTP125B	1-1/4" x 7	Black	8000	257.18
FTP125BU	"	Unichr.	8000	257.18
FTP162B	1-5/8" x 7	Black.	5000	198.97
FTP162BU	"	Unichr.	5000	198.97
FTP200B	2" x 7	Black	3500	178.35
FTP200BU	"	Unichr.	3500	178.35
FTP225BU	2-1/4" x 8	Unichr.	3000	203.47
FTP225BSQ	" Sq. Dr.	Black	3000	207.43
FTP250B	2-1/2" x 8	Black	2500	202.62
FTP250BU	"	Unichr.	2500	202.62
FTP300B	3" x 8	Black	2000	186.81
FTP300BU	"	Unichr.	2000	184.72
FTP300BSQ	" Sq. Dr.	Black	2000	186.81

FASTAP SCREWS

FASTAP PLUS DURACOAT XT EXTERIOR SCREWS

Silver Duracoat XT all-weather screws for exterior use. Self-Drilling and Self-Countersinking.

Far outlasts zinc fasteners on decks, construction, marine, etc....45° threads. Phillips head with nibs.



Self-Drilling and Toughened to Bend without Breaking

Full cartons only. Order by Box.

<u>Small Pack</u>	<u>Size</u>	<u>Box</u>	<u>List/Box</u>
DAC134	1-3/4 x 8	100	\$ 10.07
DAC138	1-3/8 x 8	100	8.62
DAC200	2 x 8	100	11.76
DAC225	2-1/4 x 9	100	15.41
DAC250	2-1/2 x 9	100	17.16
DAC300	3 x 9	100	18.50
DAC334	3-3/4 x 10	50	18.68
DAC450	4-1/2 x 10	50	26.83
DAC500	5 x 10	25	19.06
DAC600	6 x 10	25	24.25

<u>Whs Pack</u>	<u>Size</u>	<u>Box</u>	<u>List/Box</u>
DAC134W	1-3/4 x 8	1000	\$ 75.77
DAC138W	1-3/8 x 8	1000	62.27
DAC200W	2 x 8	1000	92.29
DAC225W	2-1/4 x 9	500	62.27
DAC250W	2-1/2 x 9	500	67.28
DAC300W	3 x 9	500	74.45
DAC334W	3-3/4 x 10	250	74.14
DAC450W	4-1/2 x 10	250	117.70
DAC500W	5 x 10	250	140.75
DAC600W	6 x 10	250	187.46

<u>Bulk Pack</u>	<u>Size</u>	<u>Box</u>	<u>List/Box</u>
DAC134B	1-3/4 x 8	5000	\$ 355.78
DAC138B	1-3/8 x 8	7000	383.46
DAC200B	2 x 8	3500	292.56
DAC225B	2-1/4 x 9	3000	331.76
DAC250B	2-1/2 x 9	2500	312.98
DAC300B	3 x 9	2000	279.59
DAC334B	3-3/4 x 10	1500	417.35
DAC450B	4-1/2 x 10	1000	449.40
DAC500B	5 x 10	800	569.72
DAC600B	6 x 10	2000	582.92

FASTAP MELAMINE SCREWS



Unique design joins melamine without predrilling. The Flat Head screws have nibs for a flush fit. All with Phillips drive. Unichrome finish.

Warehouse Pack: 1000 per box, Order by Box.

<u>Code</u>	<u>Size</u>	<u>Box</u>	<u>List/Box</u>
MEL100W	1 x 8	1000	\$ 40.04
MEL118W	1-1/8 x 8	1000	36.64
MEL125W	1-1/4 x 8	1000	44.89
MEL138W	1-3/8 x 8	1000	48.53
MEL158W	1-5/8 x 8	1000	58.23
MEL200W	2 x 8	1000	70.37

Bulk Pack: Order by Box.

<u>Code</u>	<u>Size</u>	<u>Box</u>	<u>List/Box</u>
MEL125B	1-1/4 x 8	8000	\$ 339.71

FASTAP TRIM HEAD FINISHING SCREWS



Gold in color. Self-drilling and self-countersinking. With 45° threads. Sq. Drive. Full boxes only.

Order by Box.

<u>Code</u>	<u>Size</u>	<u>Box</u>	<u>List/Box</u>
B150TTSQ	1-1/2 x 6	100	\$ 5.58
FTP150TTWSQ	1-1/2 x 6	1000	38.82
B225TTSQ	2-1/4 x 7	100	8.01
FTP225TTWSQ	2-1/4 x 7	1000	59.45
FTP225TTBSQ	2-1/4 x 7	3000	175.16
FTP300TTBSQ	3 x 8	2000	198.95



FASTAP BIT TIPS

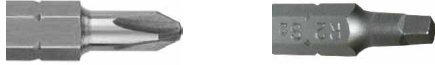

Code	Description	Ctn	List/bg
PBT #2	Phil. Hd. 2 ea/bag For 1" - 3" Screws	10 bgs	\$ 1.21
PBT #3	Phil. Hd. 1 ea/bag For 3-1/4" to 6" Screws	10	.61
SBT #1	Sq. Hd. 2 ea/bag For Trim Hd. Screws	10	1.21
SBT #2	Sq. Hd. 2 ea/bag For 1" - 3" Screws	10	1.21

SCREW COVER CAPS



Flexible plastic screw caps give a flush finished look to surfaces. Flexible grooved pegs with hollow core ensure a firm hold on screw races. Use finger or hammer to tap into screw head. Fits any #2 square drive or phillips drive.

Bulk: Sold in Full Cartons only.

Code	Color	Ctn	List/M
5525-014B	Black	1000	\$ 28.76
5525-010B	White	1000	28.75
5525-058B	Brown	1000	24.70

SPAX SCREWS

SPAX SCREWS

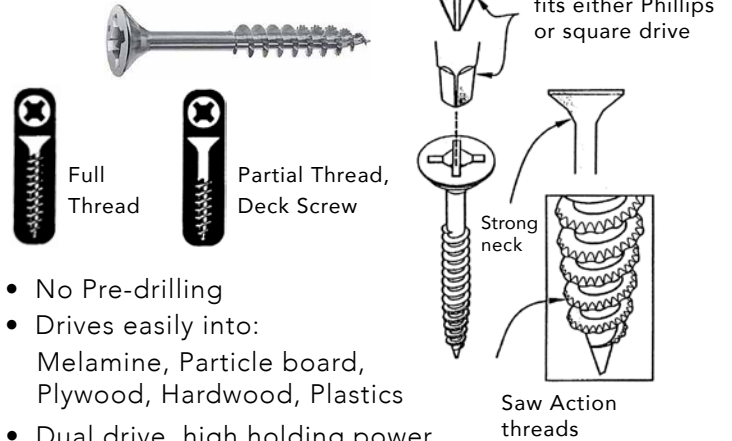

- No Pre-drilling
- Drives easily into:
Melamine, Particle board,
Plywood, Hardwood, Plastics
- Dual drive, high holding power
- Break resistant head and shaft
- Flat head, Zinc plated, 90° Countersunk
- Patented saw action threads drive without pre-drilling. Joins melamine and particle board cleanly.
- Screws are stress-relieved to reduce head and shaft breakage. Screw neck is reinforced.
- Threads are the deepest available for the best tear out resistance.

Full Thread	Size	Ctn	List/M
12-6F	1/2 x 6	1000	\$ 31.67
58-6F	5/8 x 6	1000	32.82
34-6F	3/4 x 6	1000	36.16
1-6F	1 x 6	1000	41.55
114-6F	1-1/4 x 6	1000	45.03
112-6F	1-1/2 x 6	1000	50.94
34-8F	3/4 x 8	1000	39.82
1-8F	1 x 8	1000	40.93
114-8F	1-1/4 x 8	1000	47.46
112-8F	1-1/2 x 8	1000	69.62
134-8F	1-3/4 x 8	500	71.92
2-8F	2 x 8	500	91.71
212-8F	2-1/2 x 8	500	95.07

Partial Thread	Size	Ctn	List/M
112-6	1-1/2 x 6	1000	\$ 50.51
134-6	1-3/4 x 6	1000	32.76
112-8	1-1/2 x 8	1000	60.29
134-8	1-3/4 x 8	500	53.73

Deck Screw

Partial Thread	Size	Ctn	List/M
3-8D	3 x 8	200	\$ 107.75
312-10D	3-1/2 x 10	200	141.81

CABINET CONNECTORS

TITUS CONNECTOR SCREWS

Pozi Drive, Funnel Head

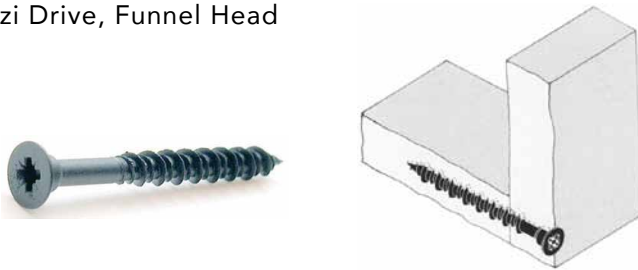

Titus Connector Screws are excellent for cabinet and wall unit construction. The Hi-Lo thread and narrow shaft offer low bursting pressure and good holding performance. Hole Boring: Simple straight through or straight blind holes drilled from one side of the board only. Drill 3mm (1/8") dia. hole for screw shank. Use on 5/8" or 3/4" board. Case hardened carbon steel. Pozidrive; funnel head.

<u>Code</u>	<u>Size</u>	<u>Ctn</u>	<u>List/M</u>
00062PH	25mm x 8mm	10000	\$ 29.98
00071PH	33mm x 8mm	14000	34.55
00077PH	45mm x 8mm	10000	39.23
06077PH	50mm x 8mm	6000	49.93
06080PH	50mm x 11mm	6000	64.54

TITUS SCREW COVER CAPS

Specifically designed for insertion into the head of the above screws. Simply knock into screw head with a hammer.



<u>Code</u>	<u>Color</u>	<u>Ctn</u>	<u>List/M</u>
01020TAO	Light Brown	1000	\$ 27.60
01020WAO	White	1000	19.96

TITUS DOWEL & CAM CONNECTORS

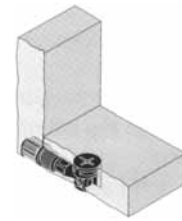

PUSH-IN DOWEL

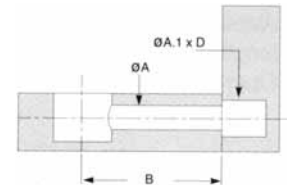

Push-in dowel with plastic expanding sleeve. Tool-free fixing of dowel into face boring cuts assembly time by 50%. Klix feature provides a strong, vibration proof connection. Dark Gray in color. Dimensions: A = 8mm, A.1 = 8mm B = 34mm, D = 12mm

<u>Code</u>	<u>Description</u>	<u>Ctn</u>	<u>List/M</u>
5554YA	Dowel, 8mm x 34mm	2000	\$ 161.57

TITUS CAM

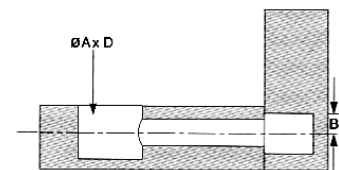

Suits all Titus dowels. Straight lower edge facilitates alignment and positioning during production. Klix feature provides a strong, vibration-proof connection. Die-cast zinc. Dimensions: A = 15mm, D = 14mm, B = 9.0-9.5mm

<u>Code</u>	<u>Description</u>	<u>Ctn</u>	<u>List/M</u>
5656ZN	Cam, 15mm x 14mm	2000	\$ 136.61

CABINET CONNECTORS

TITUS SYSTEM 6, QUICKFIT EXPANDO

20mm CamFix outrigger

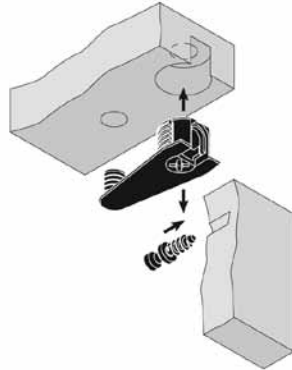

- Housing expands when cam is tightened: provides a tight joint
- Drop-on insertion of shelf panel
- All metal (stronger) or metal/plastic
- Strong vibration-proof connection with "Klix" locking feature
- Face boring only - no edge boring required
- Angle drive feature on cam for driving comfort

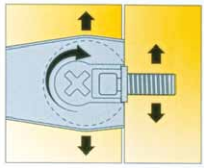

Expanding housings and dowels provide a tight joint.

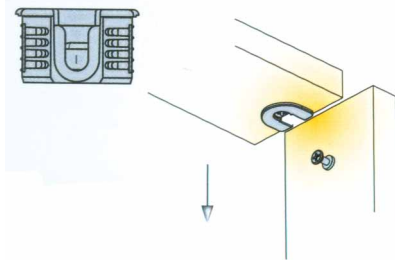

Drop-on insertion of shelf panel: only from the top.

Outrigger for 16mm (5/8") board material

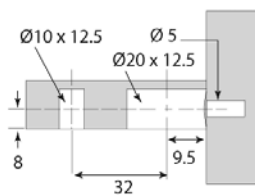

Code	Drill Depth	Panel Thickness	Color	Ctn	List/ea
06439-835	12.5mm	16mm (5/8")	Black	1250	\$.22
06439-877	12.5mm	16mm "	White	1250	.22
06439-898	12.5mm	16mm "	Brown	1250	.28
06455-847	12.5mm	16mm "	Zinc	1500	1.01
			- All metal		
06397-877	14mm	19mm (3/4")	White	1250	.24

Dowels not included - order separately.

TITUS SYSTEM 6, QUICKFIT EXPANDO

Expanding Dowels and Double-ended Dowels

Expanding Dowels

Dowel Ø5

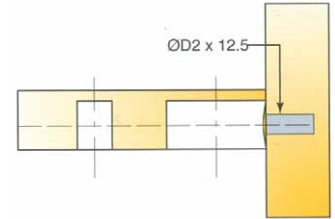
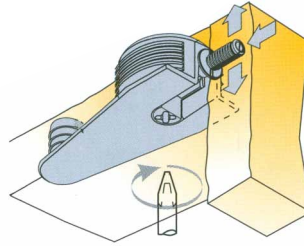

Code	Description	Ctn	List/ea.
6408	Dowel, ø5	5000	\$.10

TITUS

QUICKFIT CONNECTORS

TITUS QUICKFIT EXPANDO-6 HOUSING



06433
Drop-on

- Push-in (tool-free) housing is quick and easy to install
- Housing is high grade nylon
- Inner cam made of diecast zinc
- Housing available in a variety of plastic colors
- Suitable for 18mm/19mm board
- Connection with dowel is drop-on
- When housing is pushed into the underside of shelving, Posi-drive locking of cam may take place from above or below
- Housing expands inside panel on locking
- Klix locking system provides a strong, vibration-proof connection

Pack: 2500 each

<u>Code</u>	<u>Color</u>	<u>List/M</u>
06433AP	Oiled Cherry	\$ 256.26
06433CC	Cherry	256.26
06433GA	Hardrock Maple	256.26
06433KA	Light Brown	368.50

TITUS EXPANDO WEDGEFIX-6 CONNECTOR



06472

- All plastic connector without inner cam
- Wedgefix may be snapped into position on the dowel. It can be unsnapped, should the panel need to be relocated later.
- Corrosion-proof
- Use only push-in (tool-free) Quickfit-6 expanding dowels

Pack: 2500 each

<u>Code</u>	<u>Description</u>	<u>Color</u>	<u>List/M</u>
06472WA	Wedgefix Connector	White	\$ 201.53

TITUS QUICKFIT DOWELS

For Expando-6 Housing



06406

Screw-in Dowel:

- Has 5mm Eurothread
- Integral skirt acts as positive stop during insertion



6416

Double-ended (Dogbone) Dowel:

- For 19mm board
- Push-in (tool-free) installation

These Zinc die-cast dowels are for Ø5mm system holes; they provide a strong, vibration-proof connection.

<u>Code</u>	<u>Description</u>	<u>Ctn</u>	<u>List</u>
06406	Screw-in Dowel	5000	\$ 75.53/M
6416	Double Dowel	2500	.10/ea

20mm CMT BORING BIT - RH

Carbide tipped boring bit.
20mm diameter.
57.5mm overall length.
Shank: 10mm outside dia.



<u>Code</u>	<u>Description</u>	<u>List/ea</u>
317.200.11	RH 20mm Boring Bit	\$ 45.07

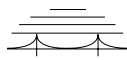

CONNECTING SCREWS

CONNECTING SCREWS

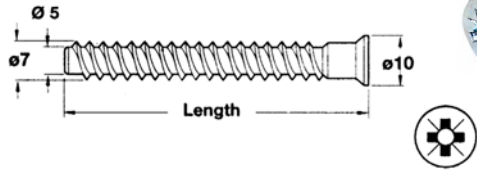

Zinc-plated, posidrive with hole for cover cap, blunt or point.

Code	Shank	Length	Ctn	List/C
10552	5mm	50mm	3000	\$ 5.56
10752	7mm	50mm	2000	9.64
02.7501.001.6.3X40	7mm	40mm	100	7.92

STEP DRILL FOR CONNECTING SCREWS

Quickscrews



overall length: 5-3/4"

Drills 3 different diameters: 5mm, 7mm, 10mm.

Code	Description	List/ea
12793	Step Drill Bit, High Speed Steel, USA	\$ 43.85

HEX HEAD CONFIRMAT SCREW

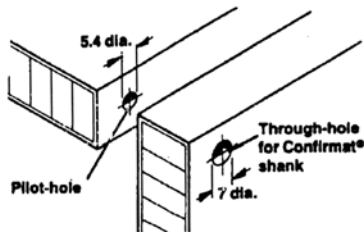

Hex. socket head 4 mm

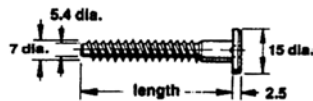

Drilling diagram
Dimensions in mm

Code	Description	Ctn	List/C
264.47.138	Bronzed, 50mm	100	\$ 22.73

CONNECTING SCREWS

QuickScrews Int'l

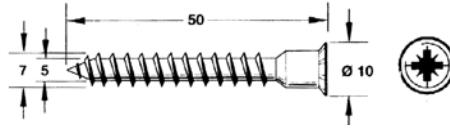

With nibs and a sharp point. Pozi Flat Head.
Size: 7mm x 50mm. Head Dia: 7.3mm - 7.5mm.
Use with cover caps.

Code	Description	Ctn	List/M
5502	7mm x 50mm	2000	\$ 62.16

CONNECTING SCREWS

QuickScrews Int'l

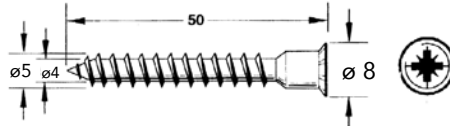

With nibs and a sharp point. Pozi Flat Head.
Size: 5mm x 50mm.

Code	Description	Ctn	List/M
13720	5mm x 50mm	4000	\$ 56.18

PANEL CONNECTORS

SEX BOLTS

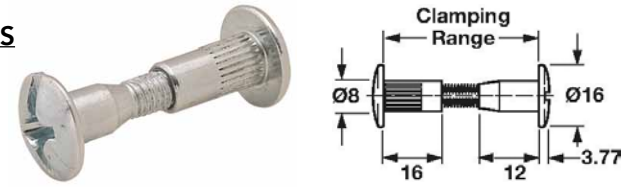

Complete fittings for connecting single furniture carcasses, base frames & constructions. For slotted or phillips. Material: steel, galvanized

Code	Thickness	Ctn	List/ea
267.07.902	32-38mm	100	\$ 1.50
267.07.903	36-42mm	100	.67

PANEL CONNECTORS

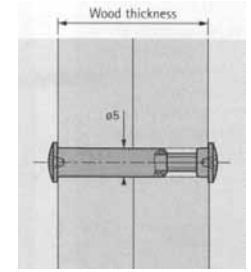
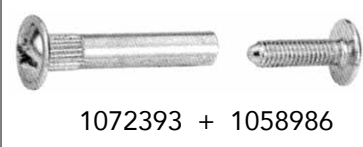

The two cabinet sides are fixed precisely by means of the long thread covers.

This panel connector has a high torque pressure. For 5mm diameter drilling. The thread cover is set back and makes it easier to screw in the connecting screw. The screw is an M4 x 15. All nickel plated steel.

Code	Thickness	Ctn	List/C
1058986	36-44mm (male)	2000	\$ 9.49
1072393	36-44mm (female)	2000	14.13

PANEL CONNECTORS

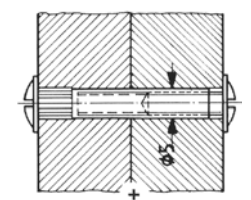
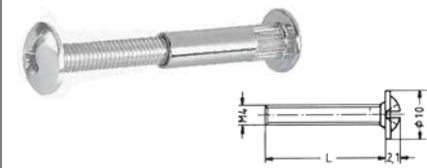

Order screw and sleeve separately. Made of nickel-plated steel. Screw is M4 x 15.

Code	Description	Ctn	List
7401M4X15	Screw, L=15mm	1000	\$ 8.63/C
749310435	Sleeve, 35mm	5000	206.89/M

DRAWER FRONT SCREWS

DRAWER FRONT ADJUSTING SCREWS

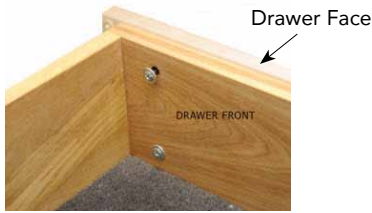

Phillips Washerhead
Coarse Thread Screw

Code	QS#	Size	Ctn	List/M
8-1DFS	1047	1" x 8	7000	\$ 31.03
8-118DFS	2757	1-1/8" x 8	6500	33.09
8-114DFS	4103	1-1/4" x 8	6500	35.58

With Type 17 Auger Point for quicker penetration in hardwoods:

Code	QS#	Size	Ctn	List/M
8-118DFS-17	9024	1-1/8" x 8	6000	\$ 32.72
8-114DFS-17	9025	1-1/4" x 8	6000	37.05

Combo-Drive (Sq/Phil), Type 17 Auger Point:

Code	Size	Ctn	List/M
12625	1" x 8	7000	\$ 32.52
12626	1-1/8" x 8	7000	36.52
12627	1-1/4" x 8	6000	33.24

CORNA QUICK CLIP

Fast nail-on alternative to figure eights, connectors, brackets and cleating for benchtops and panels. Angled screw hole for ease of screwing with optional screw for connecting components.

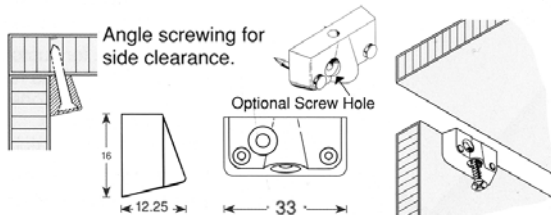

Ctn: 100 ea.

Code	Description	List/ea
QC	Quick Clip	\$.36

TITUS DRAWER FRONT ADJUSTER

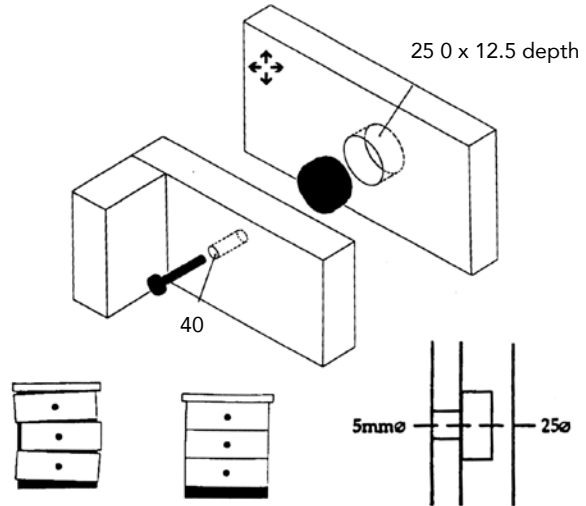

Not this.... This! Drilling Distance

Use adjuster in pairs to provide alignment on fronts attached to four-sided drawers. 2mm of adjustment in vertical and horizontal directions. Nylon material. 100 per box (8/32" machine screws are not included).

Code	Description	Ctn	List/ea
6309	25mm adjuster	100	.63
T15025	Bosch 25mm Carbide RH Drill Bit	1	40.68

FALSE FRONT CONNECTOR

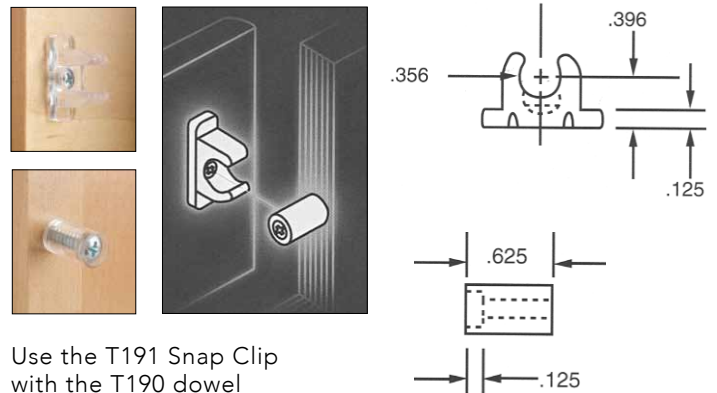

Use the T191 Snap Clip with the T190 dowel

Code	Description	Ctn	List/M
T191	Snap Clip, Clear	8,000	\$ 136.94
T190	Dowel, Screw Size: #8 x 1 Pan Hd Phil, Clear	8,000	106.16



EURO SCREWS

GRASS EURO SCREWS

Phillips Flat Head



Code	Length	Ctn	List/M
83001	7.5mm	500	\$ 85.10
81015	13mm	500	104.24
83000	18mm	500	122.16

GRASS EURO SCREW APPLICATIONS

Use Grass Euro screws with 6036, 6236, 6436, etc. metal drawer system. (Some generic Euro screws go right through the cabinet member.) Grass Euro screws are phillips drive.

The 13mm is most common. The 18mm (83000) are for use on drawer guides with "Life Saver" (O) shaped spacers (seldom used).

The 7.5mm is used where either drawer guides or Euro hinge base plates are used back to back on a "common wall".

Grass hinge base plates don't always come with prefixed Euro-screws. You can select the one which serves your need - i.e., 13mm on standard configurations, or 7.5mm for back to back mounting.

SALICE EURO SCREWS

Pozi Drive Pan Head

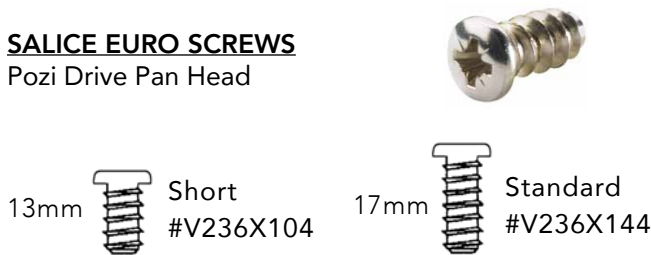

Code	Length	Ctn	List/C
V236X104	13mm	100	\$ 8.14
V236X144	17mm	100	10.22

SALICE EURO SCREWS

Salice Euro screws have a stock pan head shape which lends itself only to Salice hinges. Use short 10mm screw for common wall applications. Salice Euro-screw plates always come with prefixed screws unless they are removed at the shop.

GENERIC EURO SCREWS

Generic Euro Screws are a lower cost version of the Grass type. Quality is less consistent. Most are Pozi-drive. They are in general used for Euroslides and for ball-bearing slides.



EURO SCREWS



Code	Head dia x Length	Drive	Ctn	List/M
1220	6.3mm x 10mm	Pozi	1000	\$ 36.80
1097*	6.3mm x 10mm	Pozi	10000	31.83
13358	6.3mm x 11.5mm	Sq #2	10000	18.65
227-	6.3mm x 13mm	Pozi	10000	30.20
10589	6.3mm x 13mm	Sq #2	10000	32.49
3500	6.3mm x 13mm	Phil	10000	30.84
6061	7mm x 13mm	Pozi	3500	37.41

* Full Carton Only

Baseplates



Common Wall

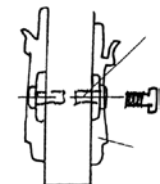

Ball Bearing Slides

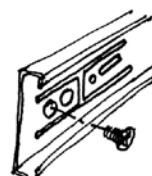

Euro Slides

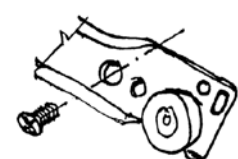

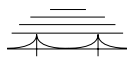

SCREWS

TRUSS HEAD MACHINE SCREWS

Quickscrews

For knobs and pulls.
Phillips/Slotted Combo.
Zinc Plated.



Code	QS #	Length	Ctn	List/C
C832-12	1206	1/2"	1000	\$ 2.46
C832-58	1207	5/8"	1000	2.97
C832-34	1208	3/4"	1000	2.84
C832-78	1209	7/8"	1000	2.84
C832-1	1196	1"	1000	2.95
C832-118	1211	1-1/8"	1000	3.27
C832-114	1212	1-1/4"	1000	3.75
C832-138	1213	1-3/8"	1000	3.45
C832-112	1214	1-1/2"	1000	3.90
C832-158	1215	1-5/8"	1000	3.99
C832-134	1216	1-3/4"	1000	3.96
C832-2	1218	2"	1000	4.97

METRIC TRUSS HEAD MACHINE SCREWS

Quickscrews

For knobs and pulls.
Phillips/Slotted Combo.
Zinc Plated.

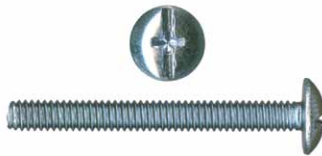

Code	Size	Ctn	List/C
10950	M4 x 25mm (1")	100	\$ 5.73
10952	M4 x 35mm (1-3/8")	100	5.03
10953	M4 x 38mm (1-1/2")	100	5.22
10955	M4 x 45mm (1-3/4")	100	5.88

BREAKAWAY TRUSS HEAD MACHINE SCREW

Quickscrews

Breakaway machine screw with Truss head and Phillips/Slotted combo drive. Zinc. Screws have 4 small Notches. Requires pliers to snap off at desired length.



Code	Size	Ctn	List/M
8903	#8-32 x 1-3/4"	1000	\$ 46.01

DRAWER SLIDE SCREWS

Phillips Truss Head,
Type AB Thread
Size: #8 x 7/16"
(Replaces 716-8AC)



Code	Color	List/C
229	Zinc	\$ 2.09
11549	Black	1.82
12649	White	5.03

Phillips Low Profile Pan Head,
Type A Thread, Zinc.
Size: #6 x 7/16"



Code	List/C
11572	\$ 1.82

Combo Truss Head,
Coarse Thread, Zinc.
Size: #8 x 7/16"



Code	List/M
10255	\$ 13.47

Phillips Truss Head,
Coarse Thread, Zinc.
Size: #8 x 7/16"



Code	List/C
4460	\$ 1.83

Phillips Round Washer Head,
Zinc, Low Profile

Code	Size	Ctn	List/M
5213 (Bulk)	#8 x 7/16"	20000	\$ 15.05
8810	#8 x 7/16"	1000	23.15
4688	#8 x 1/2"	14000	17.65





SCREWS

DECORATIVE HINGE SCREWS

Phillips Drive



Various finishes and head sizes.

Code	Description	Finish	List/M
12-5 PHFT-AB	1/2" x 5 Flat Hd	Ant. Brass	\$ 10.30
12-5 PHFT-BB	1/2" x 5 Flat Hd	Brt. Brass	9.64
12-6 PHFT-AB	1/2" x 6 Flat Hd	Ant. Brass	13.53
58-5 PHOT-AB	5/8" x 5 Oval Hd	Ant. Brass	12.61
58-5 PHFT-AB	5/8" x 5 Flat Hd	Ant. Brass	12.95
58-6 PHOT-AB	5/8" x 6 Oval Hd	Ant. Brass	16.60
58-6 PHFT-AB	5/8" x 6 Flat Hd	Ant. Brass	15.01

ROUND WASHER HEAD COMBO DRIVE

#8 x 3/4" Round Washer Head, #2 Combo Drive, Coarse Thread, Type 17 Auger Point, Zinc



Code	Size	Ctn	List/M
8883	#8 x 3/4"	10000	\$ 29.57

DRAWER SOCKET SCREWS

Pan head, sharp tipped, deep thread screw for rear drawer mounting sockets. Phillips drive.



Code	Drive	Size	Ctn	List/M
165	Phillips	#8 x 3/4"	100	\$ 21.29

With Type 17 Auger Point for quicker penetration:

Code	Drive	Size	Ctn	List/M
8086	Phillips	#8 x 3/4"	1000	\$ 23.67
13580	Square	#8 x 3/4"	1000	24.30

Truss head, sharp tipped, deep thread screw for rear drawer mounting sockets. Phillips drive.



Code	Drive	Size	Ctn	List/M
6802	Phillips	#8 x 3/4"	10000	\$ 20.16
7892	Phillips	#8 x 5/8"	10000	23.91

COARSE THREAD WOOD SCREWS

Quickscrews

Flat head Phillips wood screws for hinge cups, baseplates, drawer slides, etc. Coarse thread for better holding power. Sharp point for easy penetration into melamine. ZC: Zinc plated, NP: Nickel plated.



Code	QS #	Finish	Size	Ctn	List/M
5-12FPDT	109SG	ZC	1/2" x 5	40000	\$ 13.07
6-12FPDT	9526	ZC	1/2" x 6	25000	13.84
5-58FPDT	110SG	ZC	5/8" x 5	30000	14.11
6-58FPDT	9501SG	ZC	5/8" x 6	25000	13.44
6-34FPDT	9594	ZC	3/4" x 6	20000	16.20
6-1FPDT	123SG	ZC	1" x 6	13000	17.21
7-34FPDT	3368	NP	3/4" x 7	500	19.20
7-58FPDT	9223	NP	5/8" x 7	5000	22.96
8-58FPDT	127	ZC	5/8" x 8	14000	17.15

COARSE THREAD WOOD SCREWS

Grass

Phillips Flat Head. Nickel plated. 500/bag. One bag per carton. Sold in full bags only.



Code	Size	List/bag
81014	1/2" x 6	\$ 24.88
81001	5/8" x 6	27.94
81003	3/4" x 6	27.04
81004	1" x 6	29.43

SQUARE DRIVE COARSE THREAD WOOD SCREWS

Quickscrews

For Slides and Hinge Baseplates. #2 Square Drive, Flat Head Type 17 Auger Point. Zinc.



Code	Size	Ctn	List/M
13465	1/2" x 6	25000	\$ 15.84
13466	5/8" x 6	25000	15.14
13467	3/4" x 6	20000	16.36

PAN HEAD WOOD SCREWS

Quickscrews

Phillips Pan Head. Coarse Thread. Zinc plated.



Code	QS #	Size	Ctn	List/M
58-6 PHDT	158SG	5/8" x 6	25000	\$ 11.57

FLAT HEAD WOOD SCREWS

PHILLIPS FLAT HEAD WOOD SCREWS

Pack: 100 ea/box.
Full Boxes Only.



Zinc Plated Steel

Code	Size	List/C	Code	Size	List/C
12-4 PHFW	4 x 1/2"	\$ 4.48	112-6 PHFW	6 x 1-1/2"	5.03
12-5 PHFW	5 x 1/2"	4.72	112-8 PHFW	8 x 1-1/2"	5.46
12-6 PHFW	6 x 1/2"	4.99	112-10 PHFW	10 x 1-1/2"	6.32
58-4 PHFW	4 x 5/8"	3.64	2-6 PHFW	6 x 2"	7.04
58-6 PHFW	6 x 5/8"	3.37	2-8 PHFW	8 x 2"	8.88
34-6 PHFW	6 x 3/4"	3.34	2-10 PHFW	10 x 2"	8.84
34-7 PHFW	7 x 3/4"	4.65	212-10 PHFW	10 x 2-1/2"	13.03
34-8 PHFW	8 x 3/4"	3.80	212-12 PHFW	12 x 2-1/2"	15.54
1-8 PHFW	8 x 1"	5.11	3-10 PHFW	10 x 3"	16.25
			3-12 PHFW	12 x 3"	15.38

TRADITIONAL WOOD SCREWS											PRODUCTION SCREWS																															
Gauge	2	3	4	5	6	7	8	9	10	12	14	4	6	8	10	12	14																									
Head-Bore Size																																										
	11/64"	13/64"	15/64"	1/4"	9/32"	5/16"	11/32"	23/64"	25/64"	7/16"	1/2"	7/32"	17/64"	11/32"	23/64"	7/16"	1/2"																									
Shank-Hole Size												Shank hole is the same size as the pilot hole listed below																														
Pilot-Hole Size	Hardwood		Softwood		Hardwood		Softwood		Hardwood		Softwood		Hardwood		Softwood		Hardwood		Softwood																							
	1/16"	1/16"	5/64"	5/64"	3/32"	7/64"	7/64"	1/8"	1/8"	9/64"	5/32"	5/64"	7/64"	1/8"	9/64"	5/32"	3/16"	1/16"	3/32"	7/64"	1/8"	9/64"	5/32"																			
Available Lengths																																										
Phillips-Head Point Size	#1			#2				#3				#1	#2			#3																										
Square-Drive Bit Size	#0			#1				#2				#0	#1	#2			#3																									

WOOD® Magazine - <http://www.woodmagazine.com>

TAPPING SCREWS

PHILLIPS FLAT HEAD TAPPING SCREWS



Phillips Flat Head



Zinc Plated Steel

Pack: 100 ea/box. Full Boxes Only.

Code	Size	List/C
38-6 PHFT	6 x 3/8"	\$ 4.06
12-4 PHFT	4 x 1/2"	4.33
12-6 PHFT	6 x 1/2"	3.74
12-8 PHFT	8 x 1/2"	4.46
12-10 PHFT	10 x 1/2"	5.37
58-6 PHFT	6 x 5/8"	4.33
58-8 PHFT	8 x 5/8"	5.15
58-10 PHFT	10 x 5/8"	5.98
34-4 PHFT	4 x 3/4"	4.46
34-6 PHFT	6 x 3/4"	5.85
34-8 PHFT	8 x 3/4"	5.76
34-10 PHFT	10 x 3/4"	6.10
34-12 PHFT	12 x 3/4"	8.10
1-6 PHFT	6 x 1"	7.34
1-8 PHFT	8 x 1"	7.32
1-10 PHFT	10 x 1"	7.19
1-12 PHFT	12 x 1"	8.86
114-6 PHFT	6 x 1-1/4"	7.34
114-8 PHFT	8 x 1-1/4"	7.88
114-10 PHFT	10 x 1-1/4"	10.16
112-8 PHFT	8 x 1-1/2"	7.37
112-10 PHFT	10 x 1-1/2"	9.25
2-8 PHFT	8 x 2"	10.34
2-10 PHFT	10 x 2"	12.37

**Ant. Brass
Phillips Flat Head
Tapping Screws**



Code	Size	Ctn	List/M
12-5 PHFT-AB	5 x 1/2"	25000	\$ 10.30
58-6 PHFT-AB	6 x 5/8"	20000	15.01

PHILLIPS PAN HEAD TAPPING SCREWS



Phillips Pan Head



Zinc Plated Steel

Pack: 100 ea/box. Full Boxes Only.

Code	Size	List/C
38-4 PHPT	4 x 3/8"	\$ 3.61
38-6 PHPT	6 x 3/8"	4.22
38-8 PHPT	8 x 3/8"	4.19
12-4 PHPT	4 x 1/2"	3.91
12-6 PHPT	6 x 1/2"	5.11
12-8 PHPT	8 x 1/2"	4.67
12-10 PHPT	10 x 1/2"	4.40
58-4 PHPT	4 x 5/8"	4.34
58-6 PHPT	6 x 5/8"	6.01
58-8 PHPT	8 x 5/8"	4.81
58-10 PHPT	10 x 5/8"	5.34
34-4 PHPT	4 x 3/4"	5.28
34-6 PHPT	6 x 3/4"	4.34
34-8 PHPT	8 x 3/4"	4.97
34-10 PHPT	10 x 3/4"	4.89
34-12 PHPT	12 x 3/4"	8.77
1-6 PHPT	6 x 1"	5.25
1-8 PHPT	8 x 1"	6.67
1-10 PHPT	10 x 1"	8.88
1-14 PHPT	14 x 1"	19.52
114-8 PHPT	8 x 1-1/4"	7.03
114-10 PHPT	10 x 1-1/4"	8.80
112-8 PHPT	8 x 1-1/2"	8.21
112-10 PHPT	10 x 1-1/2"	9.15
134-12 PHPT	12 x 1-3/4"	11.40
2-10 PHPT	10 x 2"	13.44

Bulk Phillips Pan Head Tapping Screws

Code	Size	Ctn	List/M
167	8 x 1-1/4"	9000	\$ 27.27
168SG	8 x 1-1/2"	6000	28.65

SCREWDRIVER BITS

- X - Prefix for extra hardness bits to be used for driving sheet metal or case hardened screws.
- I - Prefix for intermediate hardness bits to be used for driving heat-treated screws and for impact use.



1" Standard Length



Long Length

FOR PHILLIPS SCREWS - 1/4" Hex Insert
440 Series

Code	Pt. Size	O.A. Length	List/ea
I440-1	1	1"	\$ 1.14
X440-1	1	1"	1.17
I440-2	2	1"	1.22
X440-2	2	1"	1.17
I440-3	3	1"	1.22
X440-3	3	1"	1.13
I440-22	2	2"	2.27
X440-22	2	2"	2.79
X440-23	2	3"	6.09
X440-215	2	2-1/2"	1.36

FOR POZI DRIVE SCREWS

1/4" Hex Insert
440 Series



X440-2-PZD	2	1"	\$ 1.34
X440-3-PZD	3	1"	2.14

FOR PHILLIPS SCREWS

1/4" Hex Shank
446 Series



I446-2	2	1"	\$ 1.23
X446-1	1	1"	1.30
X446-2	2	1"	1.18
11760 (QuickScrews)	2	1"	.87

FOR PHILLIPS SCREWS

5/16" Hex Shank
480 Series



I480-2	2	1-1/4"	3.31
X480-2	2	1-1/4"	2.03

SQUARE DRIVE BITS



X950
1/4" Hex Insert



X954
1/4" Hex Power Drive

Code	Description	Ctn	List/ea
X950-1	1" Square Dr, #1	10	\$ 4.74
X950-2	1" Square Dr, #2	10	1.49
X954-2	1-15/16" Square Dr, #2	10	2.32
X954-B-2	3-1/2" Square Dr, #2	10	3.54

FOR PHILLIPS SCREWS

1/4" Hex Power Drive
492 Series



Code	Pt. Size	O.A. Length	List/ea
X492	2	1-15/16"	\$ 1.89
X492-B	2	3-1/2"	2.78

MAGNETIC POWER BITS

Quickscrews



6" Power Bit. Available in Phillips or Square Drive.

Pack: 10 ea.

Code	Description	List/ea
12694	6" Phillips Drive #2	\$ 5.98
12698	6" Square Drive #2	5.74

Note:

When a #2 bit is needed we recommend the #2 446 Apex series for #5, #6 and short to medium #8 screws (this bit is also known as a #2 recess bit). The 446 series is commonly used to mount drawer slides, face frame plates, and Amerock style hinges.

The #2 440 Apex series is recommended for driving #8 and #10 screws (the 440 will fit smaller screws too, it just performs best on larger screw heads).

BIT HOLDERS

10-PIECE INSERT BIT KIT

Quickscrews



Includes:

- #1 Phillips Drive Bit
- #2 Phillips Drive Bit
- #3 Phillips Drive Bit
- #2 Reduced Phillips Drive Bit
- #1 Pozi Drive Bit
- #2 Pozi Drive Bit
- #3 Pozi Drive Bit
- #1 Square Drive Bit
- #2 Square Drive Bit
- Quick Release Magnetic Bit Holder # 11922



Kit contains 9 bits, magnetic quick release bit holder (1/4" x 2") and case.

Code	Description	List/kit
13613	10 piece Bit Kit w/ case	\$ 18.87

COMBO HEAD SCREWDRIVER BIT

Square/Phillip Drive combo Head



The 2X2QB combo head screwdriver bit has both Square drive and Phillip drive "teeth." This makes it a fine bit to use with the Quadrex white screws as well as the Spax screws. It fills both the Square drive and Phillip's recess of a Spax screw for maximum driving power.

Code	Description	List
2X2QB	Combo Head Bit	\$ 5.40

MAGNETIC BIT HOLDER



Use With 1/4" Hex Insert Bit. Body Dia: 1/4"

Code	Manufacturer	Overall Length	Pack	List/ea
11794	Quickscrews	2-7/8"	1 ea.	\$ 15.41
M490	Apex	3"	1	20.10



QUICK RELEASE MAGNETIC BIT HOLDER

Quickscrews



Stainless Steel Magnetic Bit Holder use with any type insert bit works in any standard drill chuck - Quick Release & Super Magnetic. 1/4" x 3".

Code	Description	List/ea
14203	Quick Release Bit Holder	\$ 11.74

SUPER MAGNETIC BIT HOLDER

Quickscrews



1/4" Hex Shank, Overall Length: 2-3/8"

- Can't Loose Tip
- Holds Screw Straight
- Short Length for narrow space

Code	Description	List/ea
11928	Super Mag Bit Holder	\$ 14.77



COVER CAPS

FASTCAP ADHESIVE-BACKED COVER CAPS

9/16" PVC or Real Wood

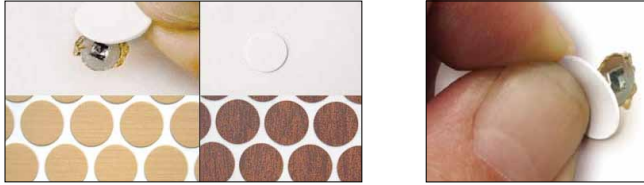

Cover caps are quick, durable, and self-adhesive. They stay in place and do not depend on the head of the screw for adhesion. The screw can be sunk far below the surface of the material and FastCaps will cover the hole effectively. Low profile so they are less likely to be noticed. Available in PVC or Real Wood. Order by the sheet.

Pack: 52 caps per sheet, 1040 caps per box
Please order in increments of 52!

<u>PVC</u>	<u>Color</u>	<u>List/C</u>
FC-WH	White	\$ 5.13
FC-AL	Almond	5.09
FC-DG	Dark Gray	5.09
FC-LG	Light Gray	5.09
FC-BL	Black	5.13
FC-HRM	Hard Rock Maple	6.44
FC-NC	Nat. Cherry	7.71
FC-BC	Bourbon Cherry	6.18
FC-SC	Select Cherry	6.47
FC-PW	Pres. Walnut	6.44

Real Wood

FC-RO	Red Oak	9.30
FC-MAP	Maple	9.30
FC-CH	Cherry	9.25
FC-MAH	Mahogany	9.30
FC-VG	Vertical Grain Fir	9.30
FC-WA	Walnut	9.27
FC-WB	White Birch	9.30
FC-AD	Alder	9.30

Real Wood, Finished

FC-MPF	Maple, Finished	11.29
FC-CHF	Cherry, Finished	11.27

11/16" Dia. FASTCAPS

White PVC , 11/16" (18mm) dia.

36 caps per sheet, 20 sheets
(720 caps) per box.

Order in increments of 36.

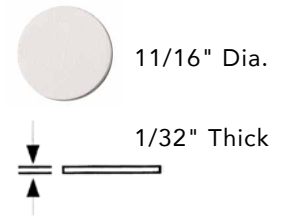

<u>Code</u>	<u>Color</u>	<u>List/C</u>
FC-1116-WH	White PVC	\$ 5.54

ADHESIVE-BACKED CASTLE COVER CAPS

Fastcap

Self-adhesive cover caps to cover holes cut by Castle Pocket Cutter machinery.

Available in PVC colors or real wood veneer.

9/16" x 2-1/2" caps, 1/32" Thick.

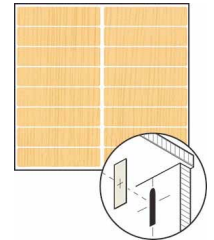

- Easy to use. They stay in place the first time you stick them over the screw hole.
- They do not depend on the head of the screw for adhesion
- The screw can be sunk far below the surface of the material and FastCaps will cover the hole effectively

Pack: 16 caps per sheet, 320 caps per box
Please order in increments of 16!

<u>PVC</u>	<u>Color</u>	<u>List/C</u>
FC-WH-CC	White	\$ 15.99
FC-BL-CC	Black	15.99
FC-AL-CC	Almond	16.03
FC-NO-CC	Natural Oak	20.02
FC-HM-CC	Hard Rock Maple	20.02
FC-MW-CC	Mahogany on Walnut	20.04
FC-NC-CC	Natural Cherry	20.02
FC-BC-CC	Bourbon Cherry	20.04

Real Wood

FC-MAP-CC	Maple	27.55
FC-CH-CC	Cherry	28.92
FC-RO-CC	Red Oak	28.92

Real Wood, Finished

FC-MP-CCF	Maple	35.18
FC-CH-CCF	Cherry	33.58

ROD DOWELS

**WADDELL RAMIN
HARDWOOD DOWELS**

Color coded retail packs



Order in pieces,
not per bundle.

Code	Size	Color	Pcs/ Bundle	List/C
18-36CCR	1/8" x 3'	Black	100	\$ 17.67
18-48CCR	1/8" x 4'	" "	100	34.24
316-36CCR	3/16" x 3'	Gray	100	21.44
316-48CCR	3/16" x 4'	" "	100	25.85
14-36CCR	1/4" x 3'	Lt. Green	100	26.93
14-48CCR	1/4" x 4'	" "	100	30.98
516-36CCR	5/16" x 3'	Red	100	27.79
516-48CCR	5/16" x 4'	" "	100	41.43
38-36CCR	3/8" x 3'	Blue	100	42.27
38-48CCR	3/8" x 4'	" "	100	75.98
716-48CCR	7/16" x 4'	Jade Green	100	84.44
12-36CCR	1/2" x 3'	White	50	67.67
12-48CCR	1/2" x 4'	" "	50	116.04
58-36CCR	5/8" x 3'	Brown	25	110.54
58-48CCR	5/8" x 4'	" "	25	167.50
34-36CCR	3/4" x 3'	Yellow	25	148.13
34-48CCR	3/4" x 4'	" "	25	195.63
78-36CCR	7/8" x 3'	Purple	15	167.10
78-48CCR	7/8" x 4'	" "	15	246.47
1-36CCR	1" x 3'	Orange	10	224.17
1-48CCR	1" x 4'	" "	10	313.96
118-48CCR	1-1/8" x 4'	Pink	10	3.53/ea
114-36CCR	1-1/4" x 3'	Dk. Green	9	3.78/ea
114-48CCR	1-1/4" x 4'	" "	9	5.67/ea

BULK PACK BIRCH WOOD DOWELS

Sold in Full Bundles Only.
Order in pieces, not per bundle.



Code	Size	Pcs/Bundle	List
38-48	3/8" x 4'	200	\$ 106.58/C
112-48	1-1/2" x 4'	25	16.42/ea

SHIMS

SHIMS

Available in Two Sizes

8" Pine Shim bundles:

12 shims per bundle,
36 bundles per box
Sold per box. (432 pcs.)
Made of Pine.



Use for

- Window Installation
- Door Installation
- Counter Top Installation
- Cabinet Installation
- Floor Leveling
- Bath Fixture Leveling
- Leveling Appliances
- Stir Sticks
- Putty Applicators
- Squeaky Floors
- Perfect for retail

12" Shim bundles:

42 shims per bundle, 12 bundles per box
Sold per box. (504 pcs.)

Made from
BeddarWood™.
Outperforms Pine
and Cedar



- Excellent snap
- Easy to cut
- Rot resistant
- Will not shrink
- Clean and consistent quality
- No moldy shims
- Certified wood
- Split resistant to nails and screws

Sold in Full boxes only

Code	Description	List/bx
SHIM-8	8" Pine Shims (432 pcs)	\$ 64.45
SHIM-12	12" Beddar Wood Shims (504 pcs)	75.66



DOWEL PINS

HARDWOOD SPIRAL DOWELS

Bulk



Code	Size	Ctn	List/M
516-112S	5/16" x 1-1/2"	15000	\$ 32.56
38-112S	3/8" x 1-1/2"	15000	36.23
38-2S*	3/8" x 2"	10500	51.42
38-212S*	3/8" x 2-1/2"	8000	59.58
12-2S*	1/2" x 2"	6000	70.38
12-212S	1/2" x 2-1/2"	4600	85.66
12-3S	1/2" x 3"	3700	105.97
12-4S	1/2" x 4"	2700	132.27

* FULL CARTONS ONLY: If less than carton quantity is desired, please order the smaller quantity bags in the next column.

HARDWOOD MULTI-GROOVE DOWELS

Bulk



Code	Size	Ctn	List/M
38-2M	3/8" x 2"	10500	\$ 47.52
38-212M	3/8" x 2-1/2"	10000	57.03
12-4M	1/2" x 4"	3500	162.05
8MMX25MM	8mm x 25mm	36000	24.70
8MMX30MM	8mm x 30mm	19200	26.52
8MMX32MM	8mm x 32mm	28200	30.75
8MMX38MM	8mm x 38mm	22500	33.97

PRE-GLUED MULTI-GROOVE DOWEL

Water Activated Glue

Blue in Color



Code	Size	Ctn	List/M
6MMX25MM-PG	6mm x 25mm	45000	\$ 38.92
8MMX32MM-PG	8mm x 32mm	28200	38.13

BAGGED SPIRAL GROOVED DOWEL PINS

500/Bag

Spiral grooved dowel pins in bags of 500.



Code	Size	List/bg
P52	5/16" x 2"	\$ 37.44
P62	3/8" x 2"	39.87
P6212	3/8" x 2-1/2"	51.80
P82	1/2" x 2"	59.23

BAGGED SPIRAL GROOVED DOWEL PINS

100/bag
25 bags/ctn.
Assortable



Code	Size	List/bg
H42	1/4" x 2"	\$ 9.71
H5112	5/16" x 1-1/2"	8.01
H52	5/16" x 2"	10.19
H5212	5/16" x 2-1/2"	12.49
H6112	3/8" x 1-1/2"	8.88
H62	3/8" x 2"	10.03
H6212	3/8" x 2-1/2"	11.55
H82	1/2" x 2"	12.78

MULTI-GROOVE DOWELS IN RETAIL BAGS

12 bags/box

Code	Size	Dowels/Bag	List/bag
F4114	1/4" x 1-1/4"	15	\$ 2.12
F5112	5/16" x 1-1/2"	15	2.12
F6200	3/8" x 2"	15	2.12
F7212	7/16" x 2-1/2"	6	2.12
F8200	1/2" x 2"	8	2.12

TABLEPINS

100 ea/bag
Full bags only.

3/8" x 1-1/4"



Code	Description	Ctn	List/C
HT	Birch Pine	5000	\$ 8.26

BUTTONS & PLUGS

SCREWHOLE BUTTONS

Mushroom



— Dia. —



In Bags of 100

Code	Dia.	Wood	Ctn	List/bg
H12B	1/2"	Birch	25 bags	\$ 9.63
H38B	3/8"	Birch	25	9.77
H34B	3/4"	Birch	10	18.43
H12BO	1/2"	Oak	10	18.42
H38BM	3/8"	Mahog.	10	16.02
H38BO	3/8"	Oak	10	15.24

In Retail Bags - 12 bags per box

Code	Dia.	Wood	Buttons/ Bag	List/bg
F38B	3/8"	Birch	15	\$ 2.12
F12B	1/2"	Birch	15	2.12
F34B	3/4"	Birch	6	2.12
F10B	1"	Birch	5	2.12

SCREWHOLE PLUGS

Round Head



In Bags of 100

Code	Dia.	Wood	Ctn	List/bg
H12RP	1/2"	Birch	25 bags	\$ 8.71
H38RP	3/8"	Birch	25	8.22
H38RPO	3/8"	Oak	10	14.45
H12RPO	1/2"	Oak	10	14.62

In Retail Bags - 12 bags per box

Code	Dia.	Wood	Buttons/ Bag	List/bg
F38R	3/8"	Birch	15	\$ 2.12
F12R	1/2"	Birch	15	2.12
F34R	3/4"	Birch	6	2.12
F10R	1"	Birch	5	1.91

SCREWHOLE PLUGS

Flat Head



In Bags of 100

Code	Dia.	Wood	Ctn	List/bg
H12FP	1/2"	Birch	25 bags	\$ 8.68
H38FP	3/8"	Birch	25	8.25
H12FPO	1/2"	Oak	10	14.73
H38FPM	3/8"	Mahog.	10	15.15
H38FPO	3/8"	Oak	10	13.13
H38FPW	3/8"	Walnut	10	15.15

In Retail Bags - 12 bags per box

Code	Dia.	Wood	Buttons/ Bag	List/bg
F38F	3/8"	Birch	15	\$ 2.12
F12F	1/2"	Birch	15	2.12
F34F	3/4"	Birch	6	2.12
F10F	1"	Birch	5	2.12

**LAMELLO
JOINTING BISCUITS**

Beech



Oval jointing plates fit easily into slot & allow adjustment for perfect alignments without jigs. Dampness of glue swells plate to great strength. Made of compressed beech. Will join panels to 3/8" thick.

Sold in full cartons only.

Code	Size	Ctn	List/M
0LA	1-3/4" Plate	1000	\$ 89.40
10LA	2-1/8" Plate	1000	89.40
20LA	2-1/2" Plate	1000	89.40

ECONOMY BIRCH BISCUITS

Porter Cable



Code	Size	Ctn	List/bx
5551PC	1-3/4" Plate	1000	\$ 54.95
5552PC	2-1/8" Plate	1000	55.39
5553PC	2-1/2" Plate	1000	55.39



CORNER BRACES

CORNER BRACES

Made of wrought steel. Screw holes countersunk on inside. 1" size has two screw holes, 1-1/2" through 4" have four screw holes, 5" and 6" have six screw holes. Zinc plated. (Screws not included.)



Code	Size	Ctn	List/C
226-1	1"	48	\$ 40.41
226-1.5	1-1/2"	48	53.01
226-2	2"	48	80.15
226-2.5	2-1/2"	24	91.68
226-3	3"	24	112.17
226-3.5	3-1/2"	24	120.68
226-4	4"	24	\$ 1.97/ea
226-5	5"	12	4.31/ea
226-6	6"	12	4.76/ea

KV HANGER PLATE

#521

Overall: 13/16" x 2", Steel is 1/16" thick.

Keyhole shape hanger plate. Use with #10 x 3/4" flathead wood screws, not included.



Code	Ctn	List/ea
521ZC	100 ea.	\$.78

KV CORNER BRACES

Zinc plated stamped steel. Use with 3/4" No. 10 flat head wood screw. 100 per box.



Code	Size	List/ea
341	1" x 1"	\$.91
342	2" x 2"	1.61

MENDING PLATES

Wrought Steel, zinc plated. Screw holes countersunk on inside. 2" size has 2 holes; 2-1/2" - 8" sizes have 4 holes; 10" size has 6 holes. (Screws not included.)



Code	Size	Ctn	List/C
225-2.5	2-1/2"	48	\$ 57.78
225-3	3"	48	59.96
225-4	4"	48	95.96
225-5	5"	24	\$ 1.01/ea

1831

GLASS CLIPS

KV MIRROR & GLASS CLIPS

Screw-apart type glass clip. 1-1/2" wide x 1-1/8" high. For 1/4" or 5/16" glass. Anochrome. 10 per box with screws.

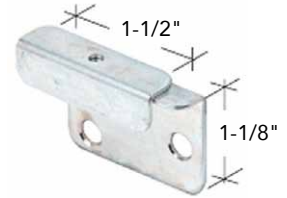

278 List \$ 7.25 ea.

One piece type glass clip. 1-1/2" wide x 1" high. For 1/4" or 5/16" glass. Anochrome. 10 per box with screws.

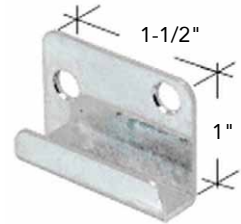

277KV List \$ 3.73 ea.

GLASS RETAINING CLIP

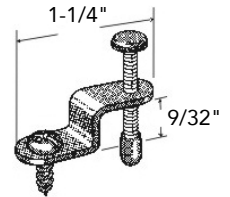

An easy-to-install way to secure glass or panels in cabinet doors or lighting fixtures. Variable for panel thickness, the rubber coating on the retaining screw protects glass. Statuary bronze finish.

Code	Description	Ctn	List/ea
2004EP	Glass clip retainer	1000	\$.60

BAINBRIDGE RABBETED GLASS CLIP

1810CL

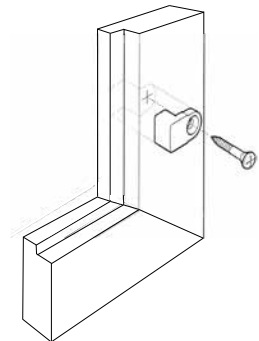

This glass clip is designed to hold glass into a rabbeted frame. Lip: 1/4". Clear in color.

Code	Ctn	List/C
1810CL	100 ea.	\$ 25.84

FASTENERS

**EXTRUDED
GLASS/PANEL
RETAINER**

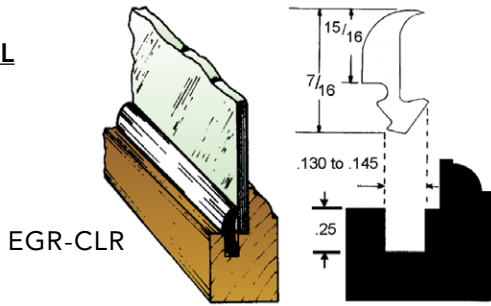

Clear, pliable plastic glass/panel retainer extrusion. Works well in cabinets with glass doors where back of door shows, and mirror-backed curios. 1000' per roll. Order by the foot.

Code	1'	100'	1000'
EGR-CLR	\$.70/ft	\$.44/ft	\$.38/ft

Amana 3 Wing Slot Cutter with 3 Wing cutter, arbor & ball-bearing. 5/32" size also used for 'biscuit-joint' cutting.

Code	Kerf	Shank	List
53407 Slot Cutter	5/32"	1/4"	\$ 36.24
53407-1* Slot Cutter	5/32"	1/2"	54.00

* Special Order

SPACE BALLS

The inexpensive solution to your age-old problem:

- Centers solid panels
- Compresses if panels expand
- Stops panel rattle
- Helps eliminate cracking glue joints

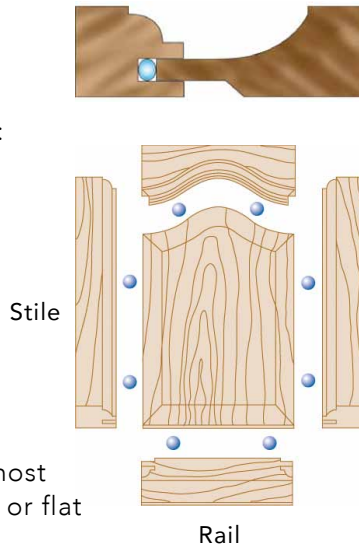

Space Balls will cut out most major call-backs on solid or flat panel doors.

Diameter: .26" - fits standard stile and rail cutters. 8-10 Space Balls recommended per door.

Code	Quantity/Box	List/M
SB1M	1000 ea.	\$ 43.47
SB5M	5000 ea.	35.42

T-NUTS

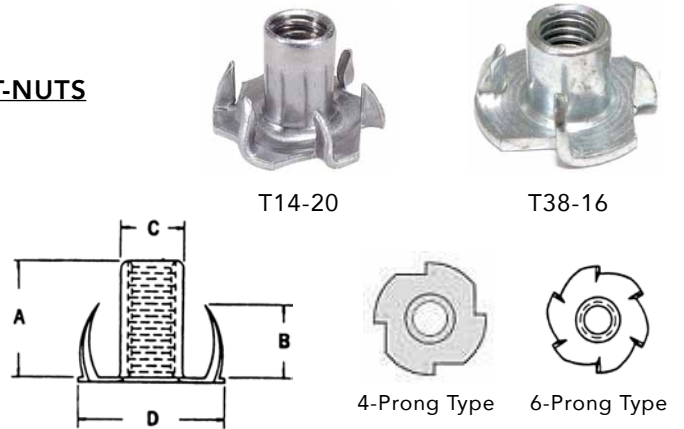

These one-piece threaded fasteners provide steel threads in wood for fast and secure assembly of components. Stamped from heavy gauge steel. Precision threaded and designed with a bevelled barrel for easier insertion. Special curved twist-type prongs bite tightly into wood. Zinc plated.

756HB:	Pack: 1000 ea.
T14-20 and T38-16:	Pack: 500 ea.

6 Prong:

Code	Thread Size	A	B	C	D	List/C
756HB*	10-24	13/32	1/4	.23	3/4	\$ 12.36
T14-20	1/4-20	7/16	7/32	.305	3/4	19.71

4 Prong:

T38-16	3/8-16	7/16	5/16	.440	1	43.56
--------	--------	------	------	------	---	-------

*Discontinued when out

Z CLIP

BEDRAIL FITTINGS

BEDRAIL FITTINGS

Can be used as a right or left hand fitting. Particularly sturdy version for hooked connection. Bright Steel. 10 sets per box. (i.e. 40 hooks and 40 latching plates).

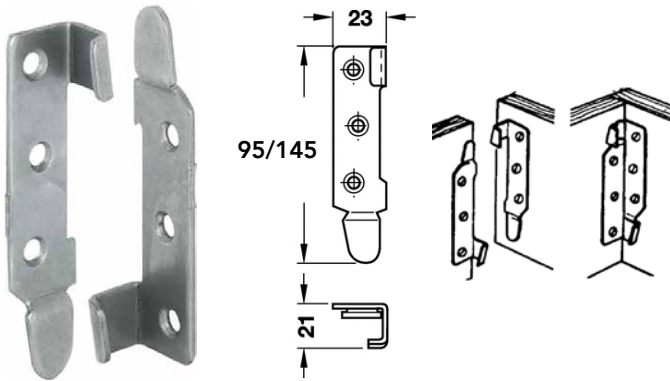

Available in two lengths: 95mm and 145mm. One set accommodates the four corners of the bed.

Code	Length	List/set
271.05.906	95mm	\$ 12.68
271.05.915	145mm	17.04

PATWIN "Z" CLIP

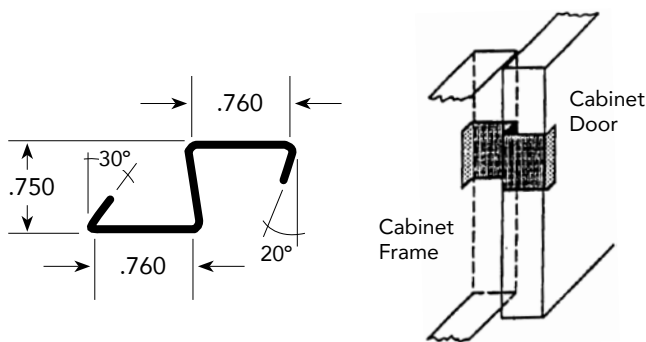

The "Z" Clip keeps cabinet doors and drawers closed during shipment to job site. Made from extruded plastic.

Code	1 ea.	1,000	5,000	10,000
449306	\$ 156.56/M	107.62/M	89.66/M	126.38/M

PARKER BEDRAIL HANGERS



Plain wrought steel bed fasteners. Ideal for beds having narrow rails. One set consists of one male hook piece and one female eye piece. Countersunk for 1-1/2" x 10 flat head screws.

6 sets/box.

Code	Size	List/set
1614-4	4"	\$ 10.04
1615-5	5"	8.69
1616-6	6"	9.69

INSET DOOR STOP

Tenn-Tex

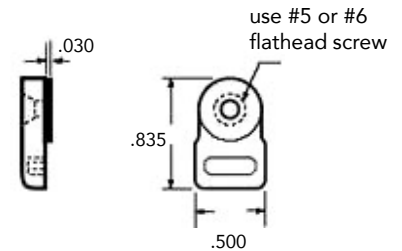

Door stop for cabinet inset doors. Clear in color. Uses #5 or #6 flathead screws (sold separately).

Code	Ctn	List/C
T230	1000 ea.	\$ 12.79

INSET EURO DOOR STOP Fastcap
"Cam" adjustable inset stop

ED-BR



ED-CL



Easy to Adjust

Screw Euro Door Stop at desired depth

Designed for use with inset cabinets. Simply screw inside cabinet and rotate to adjust where you want the cabinet door to shut.

Code	Color	Ctn	List/ea
ED-BR	Brown	100 ea.	\$.20
ED-CL	Clear	100	.44



FASTENERS

KV TITE-JOINT FASTENERS



Drill guide accurately locates both hole positions in wood pieces. Designed for use on 3/4" stock.

Applies even, controlled pressure between joint members. Solid joint without glue. For 3/4" wood. Packed 100 or 25 per box. One installation drill and guide pack in each box. Zinc.

Code	Description	Ctn	List/ea
516-100*	Joint Fastener	100	\$ 3.27
516-25*	Joint Fastener	25	3.65
516-80	Tightening Assembly	100	2.35

* Full Ctns. Only

KV JOINT FASTENERS



Bolt 4" long. Thread Length: 3-1/2".
Plate Size: 7/16" x 3/16" x 1". Can be used in 5/8" wood. 100 complete fasteners per box.

Code	Description	Ctn	List/ea
513	Joint Fastener	100	\$ 1.36

KV DESK TOP FASTENERS

Wrought Steel



1547



1548

Code	Description	Ctn	List/ea
1547	12 Gauge	100/bx	\$.49
1548	18 Gauge	500/bx	.32

DRAW BOLT CONNECTOR



Easy to install fastener which makes a smooth, tight joint. Hex Head Bolt: 1/4-20 x 3-1/2".

Code	Description	Ctn	List/C
DRAW BOLTS	Hex Head Joint Bolt	500	\$ 31.30

KV STEEL TABLE TOP FASTENERS

Nickel finish.
Pack: 100 ea/ctn.



Code	Description	List
320	1" Wide, 11 Gauge Steel	\$.61/ea
323	5/8" Wide, 14 Gauge Steel	33.97/C
324	3/4" Wide, 14 Gauge Steel	44.68/C

TOGGLERS

TOGGLER SCREW ANCHORS

from Mechanical Plastics

There are three features that all the Toggler Screw Anchors have in common:

- 1) They all use a 5/16" hole.
- 2) All the anchors will take a screw size from a #6 thru #14.
- 3) All the anchors will work in walls that are thicker than the size range on the box or package (so they can work in a semi-toggled position as a wedge anchor, or in solid material as an expansion anchor).

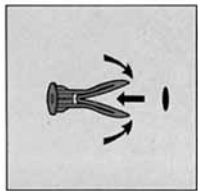

1. Fold anchor.

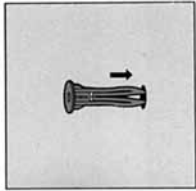

2. Insert anchor in 5/16" hole and tap flush with wall.

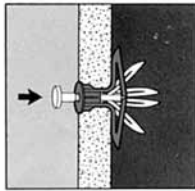

3. Insert setting key and pop anchor open (except in thick or solid walls)



TA



TB



TC

100 Toggles per box. Full Boxes only.

<u>Code</u>	<u>Description</u>	<u>List/bx</u>
TA100	Hollow Door, 1/8" - 1/4"	\$ 23.15
TB100	Drywall, 3/8" - 1/2"	24.50
TC100	Plaster Wall, 5/8" - 3/4"	27.39

TOGGLE BOLTS

from Mechanical Plastics



BA & BB:
3/16" - 1/4" Bolt



BC & BD:
3/8" - 1/2" Bolt

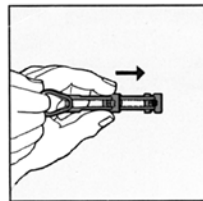

4. Slide plastic cap along straps with other hand until flange of cap is flush with wall.

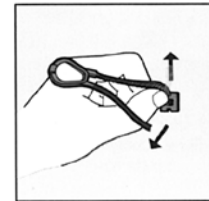

5. Place thumb between straps. Push side to side, snapping off straps level with flange of cap.

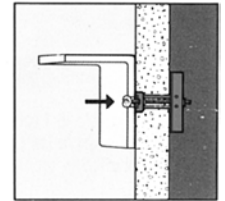

6. Place item over flange. Insert bolt and tighten until snug against item, then stop.

Full Boxes only.

<u>Code</u>	<u>Takes Bolt Size</u>	<u>Ctn</u>	<u>List/bx</u>
BA100	3/16" -24	100	
BB100	1/4" -20	100	
BC25	3/8" -16	25	

TOGGLE BOLTS

E-Z ANCHOR

Quickscrews

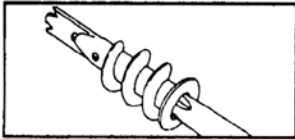

1. Place #2 Phillips screwdriver into recess of E-Z Anchor.

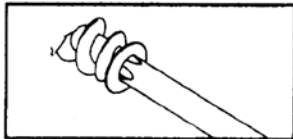

2. Press into wallboard while turning anchor clockwise until seated flush with the wall.



3. Place fixture in position, insert screw (#8 type A or AB screw is recommended).

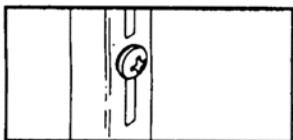

4. Tighten fixture in place (a min of 1" engagement is recommended).

The E-Z- Anchor is faster than any toggler. It pilots and sinks itself so you don't need a stud. No pre-drilling or hole preparation necessary. It is easily backed out. Uses standard #8 Tapping (sheet metal) screw.

Sold in Full Boxes Only.

Code	Description	Box	List/bx
1436QS	Zinc Anchor, #8	100	\$ 28.82

HEAVY DUTY TOGGLER

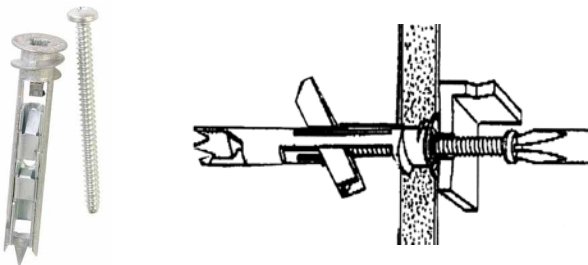

The EZ-Toggler is a self-drilling toggle bolt for heavy-duty anchoring to dry wall. With a 2-1/8" x #8 washer face phillips pan head sheet metal screw. 50 per box, sold in full boxes only.

Code	Description	Box	List/bx
EZ-TOG	Heavy Duty Toggle Bolt	50	\$ 75.89

TOGGLER SNAPSKRU™ from Mechanical Plastics

Self-Drilling Drywall Anchor

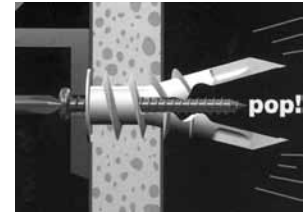

Drywall Thickness	Holds Up To
3/8"	57 lbs.
1/2"	79 lbs.
5/8"	135 lbs.

Holding values: Per anchor with #8 x 1-1/2" screws.
Industry standard safe holding = 1/4 of ultimate load.

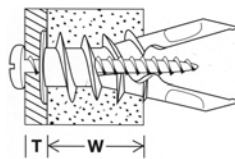

(T) Item thickness
Max. 3/4" (19mm)
with screw in box

(W) Wall thickness
Min. 3/8" (10mm)
Max. 5/8" (16mm)

For thicker items, use longer screw

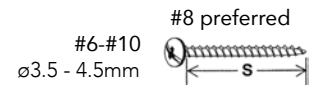
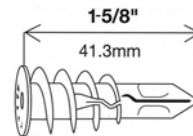

S = Item thickness + 1-1/4" (32mm)

- Anchor locks on wall - hear it "pop" and lock
- Shock-resistant
- Vibration-resistant
- Installs with screwdriver or screw gun
- Positive stop resists overturning
- Can remove screw & item, leaving anchor in wall for reuse

Sold in Full Boxes only.

Code	Description	List/box
30012	50 Anchors with 50 #8 x 1-1/2 Combo Hd screws	\$ 15.90