

PANIC HARDWARE

**VON DUPRIN
88 SERIES RIM DEVICE**



All Special Order

The sleek versatile 88 series is constructed of cast aluminum, bronze, and stainless steel. All devices in this series are UL rated for accident hazard and casualty hazard.

The patented 88 rim series is reversible and fits doors up to 3'8" wide. Roller strike #299 is included. Cylinders are also included; uses Von Duprin #3216 rim type with Schlage "C" keyway. Has dogging feature for push-pull operation. Packed stock-size knocked down, one per box.

Avail. Finishes: US26, US26D, US3, US4, US10B, US10, SPBLK

Dimensions

Crossbar Length (field sizable).....	42"
Crossbar Tubing.....	1" O.D.
Crossbar Ht. from finished floor.....	36-13/16"
Crossbar Proj. - Neutral.....	4-3/4"
Depressed.....	4"
Lock stile case.....	8-1/4" x 2-3/4" x 15/16"
Hinge stile case.....	6" x 1-3/4" x 15/16"

4

Using Standard Trim	Backset of O.S. Trim	Min. W of stile
Single door using 263 strike	* 2-7/8"	* 4-1/8"
Single door using 1405 J strike	* 2-1/8"	* 3-3/8"
With Von Duprin mullion	3"	4-1/4"

* When stop is 1/2"

88 SERIES STANDARD TRIM EO (Exit Only) - No Trim / See next page for jamb details

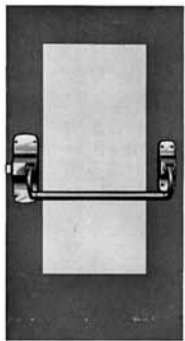

88NL
Night Latch
Key retracts
latchbolt



88TP
Thumb Piece
Key locks
thumbpiece



88DT
Dummy Trim
Pull when
dogged



88K
Knob
Key locks
knob

Code	List/ea
88DT-4	\$ 1200
88DT-26	1600
88EO-4	1100
88EO-26D	1160
88NL-4	1339
88NL-26D	1400
88TP-4	1350
88TP-26D	1400

Includes Schlage "C" Cylinder where applicable

88 SERIES VERTICAL ROD DEVICES - All Special Order

These stylish vertical rod devices display quality of design, material, and workmanship. UL rated and reversible, they will fit doors up to 3'8" wide. Price includes cylinder.

Avail. Finishes: US26, US26D, US3, US4, US10B, US10, SPBLK

Patented features include a bottom latch which combines hinged bolt and deadbolt operations, and fits all conventional still conditions. Sets are furnished with 299 top strike and 248BL-4, 304L bottom strikes. Uses Von Duprin #3216 rim with Schlage "C" keyway cylinders. Dogging feature, packed stock size, knocked down, one set/box.

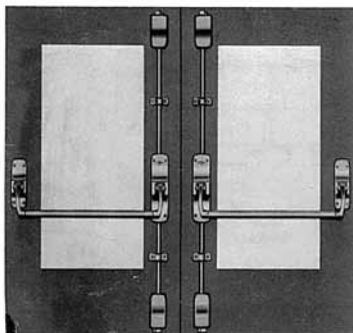

Inactive

Active (specify trim)



Other Trims and Finishes Available

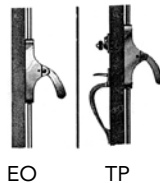

EO TP

Code	List/ea
8827EO-4	\$ 1237
8827EO-26D	1640
8827TP-4	1078
8827TP-26D	1111

Dimensions

Floating Axles Dia.	3/8"
Crossbar Length (field sizable).....	42"
Crossbar Tubing.....	1" O.D.
Crossbar Ht. from finished floor.....	13-13/16"
Crossbar Proj. - Neutral.....	4-3/4"
Depressed.....	4"
Lock stile case.....	8-1/4" x 2-3/4" x 15/16"
Hinge stile case.....	6" x 1-3/4" x 15/16"
Vertical rods.....	1/2" O.D. tubing

Double doors require divergent bevels



PANIC HARDWARE

VON DUPRIN
99 SERIES RIM / VERTICAL ROD DEVICE

All Special Order

99 Rim exit device (w/ grooved case) for all types of single and double doors with mullion, UL listed for panic exit hardware. **For Double Doors use 2 each Vertical Rod Devices, OR 2 each Rim Devices with a mullion.**

Devices are ANSI A156.3 – 2008 Grade 1. Rim device is non-handed except when the following device options are used: SD (special dogging), -2 (double cylinder) or SS (signal switch). Covers stock hollow metal doors with 86 or 161 cutouts on single doors (may cover cutouts on pairs – consult template).

Avail. Finishes: US3, US3A, US4, US4A, US10, US26, US26D, US26D-AM Antimicrobial, US28, 313, 315 & 643E.

99 SERIES STANDARD TRIM EO (Exit Only) - No Trim



990TP Rim
or
9927TP Vertical

Key Locks/Unlocks
Thumbpiece



996L* Rim
or
9927* Vertical

Key Locks/Unlocks Lever
*Breakaway Lever

99EO - No Trim
Exit Only Rim Device

9927EO - No Trim
Exit Only Vertical Rod



#99 Rim Device - For Wide Stile or Flush Doors



For Accident Hazard

4

#9927 Vertical Rod Device - Surface Mounted

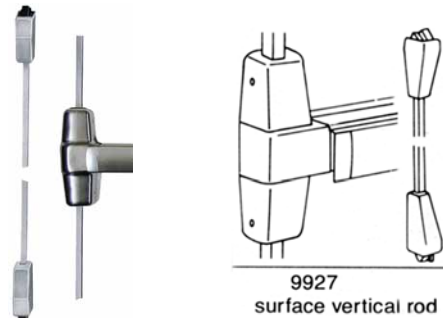

9927
surface vertical rod

VON DUPRIN #99 RIM DEVICE All Special Order

For wide stile or flush doors. Non-handed. Field sizeable, 3/4" throw, latch bolt. Latch bolt is deadlocking. Hex key dogging. Keyed trim includes Schlage "C" cylinder.

Door Requirements: 2'6" - 3' wide.
Minimum Stile: 3-13/16", 1-3/4" thick.

Code	Finish	List/ea
99EO-26D	Dull Chrome	\$ 1118
99EO-313	Duronodic Bronze	1036
99TP-26D	Dull Chrome	1408
99TP-313	Duro. Bronze	1337
99L-26D	Dull Chrome	1589
99L-313	Duro. Bronze	1521
4954	Mullion, up to 7' 2"	500

VON DUPRIN #9927 SURFACE MOUNTED VERTICAL TYPE ROD DEVICE - All Special Order

For all types of single or double doors. Non-handed. Field sizeable, 5/8" throw & latch bolt, deadlocking latch bolt, hex key dogging. Keyed trim includes Schlage "C" cylinder.

Door requirements: 2'6" - 3' wide
Minimum Stile: 3-5/8", 1-3/4" thick, 7' high

Code	Finish	List/ea
9927EO-26D	Dull Chrome	\$ 1616
9927EO-313	Duronodic Bronze	1574
9927TP-26D	Dull Chrome	1906
9927TP-313	Duro. Bronze	1875
9927L-26D	Dull Chrome	2087
9927L-313	Duro. Bronze	2059

* The Breakaway Lever design allows the lever to break away and drop to the "down" position when abused, discouraging further abuse and protecting its internal parts. The "downed" lever can then be snapped back into an operable position easily, thus preventing needless loss of door operation and costly maintenance time.



FIRE RATED, MORTISE, OR OTHER SPECIAL PANIC HARDWARE

SPECIAL PANIC HARDWARE

Von Duprin devices may be ordered for FIRE RATED doors, MORTISE applications, NARROW stiles or situations requiring special trim functions, finishes, door alarms, or remote door control systems.

4

Please call for more information and quotes. Lead time is usually 1-2 weeks, however, some items may take longer.



88-F Rim Fire Exit Device

88-F fire exit rim devices for all types of 4' X 8' single and 8' X 8' double doors with 9954 mullion, UL listed, 3 hours. This device is handed.



8875 Mortise lock exit device

8875 mortise lock devices for all types of single or double doors, UL listed for accident hazard installations. Fits stock hollow metal doors with 86 cutouts and door stiles as narrow as 4 3/4". Field reversible but comes handed from factory. The 7500 mortise lock is equipped with a 3/4" anti-friction latch bolt which is field reversible without removing the lock from the door. It has a non-handed auxiliary bolt for deadlocking and a faceplate with an adjustable bevel.



8875 & 8875-F (also available Fire-Rated)



99-F Rim Fire Exit Device

99-F Rim fire exit devices for all types of single doors up to 4' x 10' or 8' x 10' double doors with 9954 or 9854 mullion, UL listed for fire exit hardware. Devices are ANSI A156.3 – 2008 Grade 1.



9975 Mortise lock exit device

9975 Mortise lock device for all types of single or double doors, UL listed for Panic exit hardware. Devices are ANSI A156.3 – 2008 Grade 1. Fits stock hollow metal doors with 86 cutout and door stiles as narrow as 4 3/4". The mortise lock device is non-handed except when the following device options are used: -2 (double cylinder) or SS (signal switch). The 7500 Mortise lock is equipped with a 3/4" anti-friction latch bolt which is field reversible without removing the lock from the door. It has a non-handed auxiliary bolt for deadlocking and a faceplate with an adjustable bevel.



9975 & 9975-F (also available Fire-Rated)



EDGE PULLS

**BALDWIN
EDGE PULL**

Solid Forged Brass

3.875" x .75" x 1.625"

Spring loaded, returns lever flush with face plate. Narrow design eliminates installation problems on thin doors. One per box with screws.

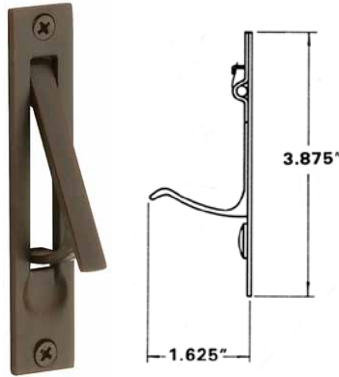

Code	Finish	List/ea
0465-030	Polished Brass	\$ 16.18
0465-260	Bright Chrome	16.18
0465-102	Oil R. Bronze	16.18
0465-264	Dull Chrome	16.18
0465-050	Sat. Brass & Black	16.18
0465-150	Satin Nickel	16.18
0465-151	Antique Nickel	16.18
0465-112	Venetian Bronze	16.18
0465-402	Distr. Oil R. Bronze	17.19

IDH EDGE PULL

Solid Brass

Polished Solid Brass. Rugged construction. The 3/4" width allows installation on both narrow and standard doors. Spring automatically returns lever flush with plate.

3-7/8" x 3/4" x 1-5/8" with screws.



Pack: 10 each

Code	Finish	List/ea
14020-003	Polished Brass	\$ 9.99
14020-015	Satin Nickel	11.11
14020-026	Polished Chrome	10.36
14020-26D	Dull Chrome	10.36
14020-10B	Oil Rubbed Bronze	13.73

POCKET DOOR LOCKS

IDH POCKET & SLIDING DOOR LOCKS

Height: 2-3/4", Width: 2-1/2"

PASSAGE: Door pull has flush pulls on both sides. Fully adjustable for 1-3/8" to 1-3/4" thick doors. 10 each per box.



Code	Finish	List/ea
25410-003	Polished Brass	\$ 11.93
25410-005	Antique Brass	13.73
25410-10B	Oil R. Bronze	14.22
25410-026	Polished Chrome	13.73
25410-26D	Dull Chrome	13.73
25410-015	Satin Nickel	14.22
25410-15A	Antique Nickel	16.48

PRIVACY: Lock and unlock by thumb turn inside pull. Emergency entry from outside. For 1-3/8" thick doors. 10 each per box.



Code	Finish	List/ea
25411-003	Polished Brass	\$ 13.48
25411-005	Antique Brass	15.85
25411-10B	Oil R. Bronze	16.23
25411-026	Polished Chrome	15.85
25411-26D	Dull Chrome	15.85
25411-015	Satin Nickel	16.23
25411-15A	Antique Nickel	17.98

**IVES SLIDING DOOR
PRIVACY BOLT**

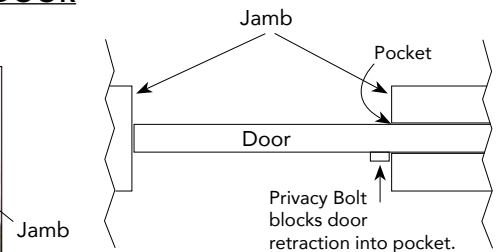

Spring activated design. Mortise depth: 3/8". Emergency release of bolt from outside the door. Solid Brass. Size: 15/32" x 3-1/16" x 5/8", Strike: 1" x 3/4".

Code	Finish	Ctn	List/ea
42B10B	Oil R. Bronze	10 ea.	\$ 12.64
42B15	Satin Nickel	10	12.13
42B26D	Dull Chrome	10	12.64
42B3	Polished Brass	10	11.02

4



POCKET DOOR LOCKS

PRIVACY POCKET DOOR LOCK

For 1-3/4" and 1-3/8" Thick Doors

4

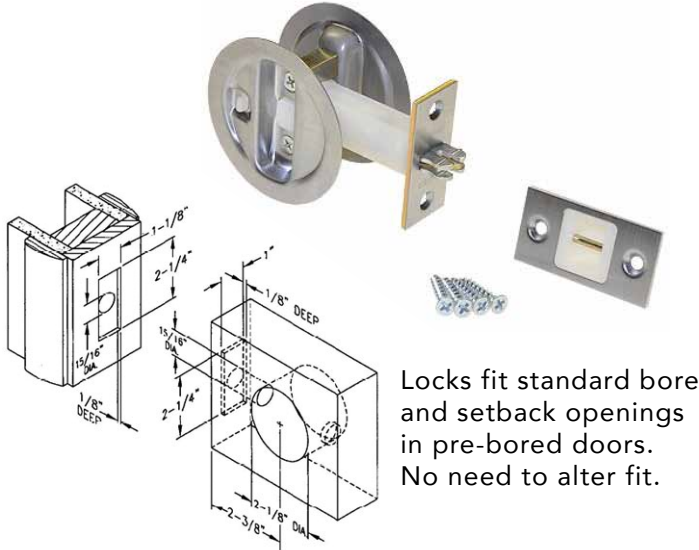

Code	Door Thickness	Finish	List/ea
1521-3	1-3/8"	Pol. Brass	\$ 28.20
1521-26D	1-3/8"	Sat. Chrome	35.81
1534-3	1-3/4"	Pol. Brass	33.81
1534-26D	1-3/4"	Sat. Chrome	40.23

ERIC MORRIS OVAL FLUSH PULL

Solid Brass - Moreland Design

82010
Heavy wrought brass recessed pull

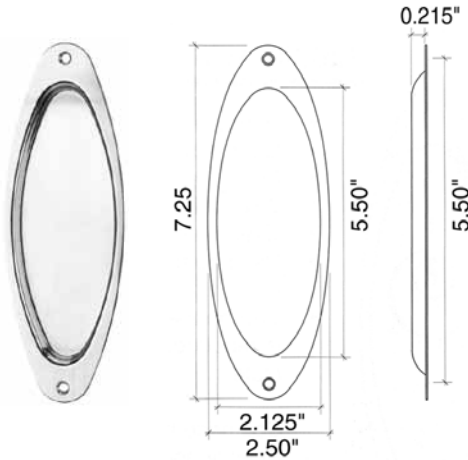

Code	Finish	List/ea
82010-605	Polished Brass	\$ 50.00
82010-613	Oil Rubbed Bronze	50.00
82010-619	Satin Nickel	50.00

ERIC MORRIS MORTISE POCKET DOOR LOCK

Solid Brass - Moreland Design

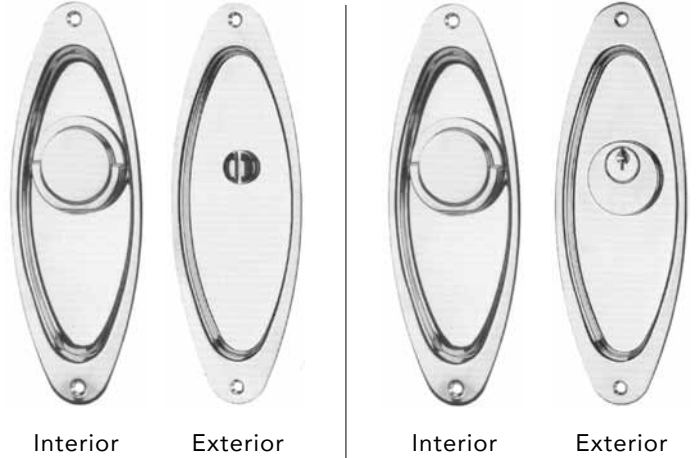

Privacy - 82091
Drop Ring Pull inside turns to activate latch. Emergency release outside can be activated by a coin.

Entry - 82093
Drop ring inside turns to latch or unlatch. Locks with key on outside.

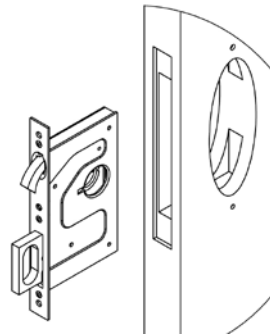

Heavy Duty Steel case has a built-in edge pull.
Overall size: 8" x 3-1/2" x 7/8"
Recess depth: 0.25"
Backset on lock box: 2.5"
Case Size: 3.5" x 5.75" x 0.563"
For doors 1-3/8" to 3" thick
Material gauge: .04"

Each Set includes trim and mortise box.

Code	Function	Finish	List/st
82091-605E	Privacy	Lifetime Pol. Brass	\$ 365.00
82091-613	Privacy	Oil R. Bronze	296.88
82091-619	Privacy	Sat. Nickel	296.00
82093-605E	Entry	Lifetime Pol. Brass	437.00
82093-613	Entry	Oil R. Bronze	344.00
82093-619	Entry	Sat. Nickel	344.00

SLIDING DOOR LOCKS

ERIC MORRIS MORTISE POCKET DOOR LOCK

Bryn Mawr Design - **Special Order**



Interior Exterior

Entry - 82193



Interior Exterior

Privacy - 82191

Bryn Mawr Pocket Door Lock:

- Rectangular Plate with Recessed Center
- Brass Recessed Pull Ring
- Solid Forged Brass Finger Pull
- Hand Polished
- Complete sets: Passage, Privacy, Bit Key set, Single/ Double Cylinder sets and more

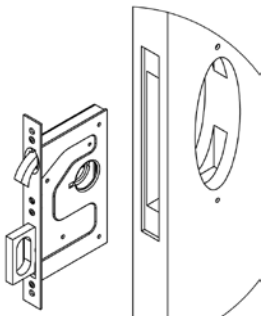

Heavy Duty Steel case has a built-in edge pull.
Overall size: 8" x 3-1/2" x 7/8"
Recess depth: 0.25"
Backset on lock box: 2.5"
Case Size: 3.5" x 5.75" x 0.563"
For doors 1-3/8" to 3" thick
Material gauge: .04"

Each Set includes trim and mortise box. Finishes available as Standard, Distressed, and PVD Brass. See below for some finish examples.

Standard: 605 (Pol. Brass), 613 (Oil R Bronze), 619 (Sat. Nickel), 626 (Sat. Chrome)

Distressed: 609D (Distr. Satin Brass), 613D (Distr. Oil R Bronze)

All Special Order.

Code	Function	(Std) 605, 613 619, 626	(Distr) 609D 613D	PVD Brass 605E
82190	Passage	\$ 321	\$ 357	\$ 409
82191	Privacy	294	326	365
82193	Entry	344	383	437

BALDWIN SLIDING DOOR LOCKS

The Santa Monica style puts a visual emphasis on vertical and horizontal lines, with a focus on pure geometry without sacrificing comfort. Available in both Large and Small varieties in Satin Nickel and Oil Rubbed Bronze. Other finishes available special order.



4

PD005-150-PRIV

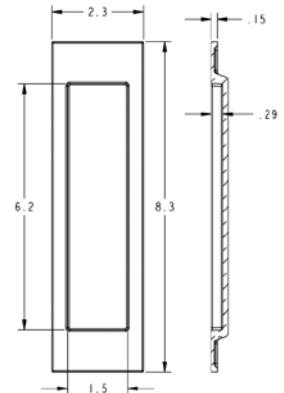

Min. Door Thickness: 1-3/4"

PD006-102-PRIV

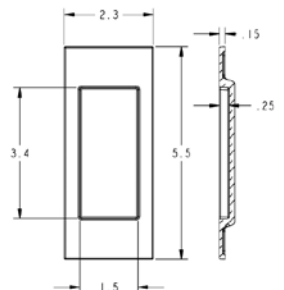

Min. Door Thickness: 1-3/8"

Code	Description	Finishes	List/ea
PD005-XXX-PASS	Passage set w/ 2.5" backset lock	102, 150	\$ 475.17
PD005-XXX-PRIV	Privacy set w/ 2.5" backset lock	102, 150	540.89
PD005-XXX-IPS	Passage Trim-Half pair	102, 150	106.16
PD006-XXX-PASS	Passage set w/ 2.5" backset lock	102, 150	434.73
PD006-XXX-PRIV	Privacy set w/ 2.5" backset lock	102, 150	500.45
PD006-XXX-IPS	Passage Trim-Half pair	102, 150	85.94

102: Oil R Bronze 150: Satin Nickel



FINGER & FLUSH PULLS

IDH FLUSH SLIDING DOOR PULL



25420-005

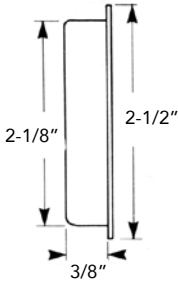

Wrought Brass.
Hand polished.
Overall Diameter: 2-1/2"
Built-in prongs
eliminate need for
screws.

Pack: 10 each.

Code	Finish	List/ea
25420-003	Polished Brass	\$ 2.64
25420-005	Antique Brass	3.38
25420-015	Satin Nickel	3.18
25420-026	Polished Chrome	3.18
25420-26D	Dull Chrome	3.18
25420-10B	Oil Rubbed Bronze	3.18
25420-15A	Antique Nickel	3.13

IVES FLUSH SLIDING DOOR PULL

Wrought brass.
Hand polished.
Overall Dia: 2-7/16"
Built-in prongs
eliminate need for
screws.



221B26

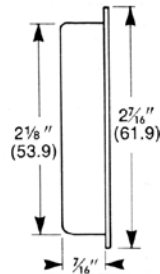

Code	Finish	Ctn	List/ea
221B10B	Oil Rubbed Bronze	20	\$ 3.57
221B26	Polished Chrome	20	3.54
SP221B15	Satin Nickel	25	3.86

KV FLUSH FINGER PULLS

Overall Diameter: 31/32",
Bore: 25/36",
Depth: 1/4"



801X

Code	Finish	Ctn	List/ea
801X	Brass	100	\$ 1.34
801XNP	Nickel	100	1.42

IDH RECTANGULAR FLUSH PULL

- Premium Quality Forged Solid Brass
- Shallow depth / Low profile
- Ideal for louvered, bifold or closet doors

Length: 3-1/8", Width: 1-5/16",
Depth: 5/16", Overall Depth: 3/8"

Pack: 10 each with screws

Code	Finish	List/ea
25400-003	Polished Brass	\$ 14.74
25400-005	Antique Brass	14.71
25400-015	Satin Nickel	14.71
25400-026	Polished Chrome	14.71
25400-10B	Oil Rubbed Bronze	14.71
25400-15A	Antique Nickel	14.71
25400-26D	Dull Chrome	14.71



25400-015

BALDWIN FLUSH PULL

Solid Forged Brass

1-1/2" x 3-1/2" x 3/8" Deep.

Clearance required is .187" projection from mounting surface. Thickness of flange is .187". Decorative flush sliding door pull may be used as a sash lift.

Colonial design makes it suitable for Early American interiors. Extra heavy solid brass construction. Screws included. 1 ea/box.

Code	Finish	List/ea
0458-030	Pol. Brass	\$ 23.25
0458-102	Oil R. Bronze	23.25
0458-150	Satin Nickel	23.25
0458-112	Venetian Bronze	23.25



0458-102

FINGER AND FLUSH PULLS

IVES FLUSH PULLS

227 - Wrought Brass

Contoured for ease of pulling.
Extra deep well.

3-5/8" x 1-3/4" x 9/16".
With screws.

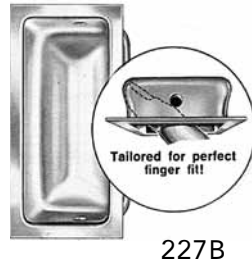

227B

Code	Finish	Ctn	List/ea
227B3	Pol. Brass	10 ea.	\$ 7.89
227B26	Pol. Chrome	10	9.10
227B15	Satin Nickel	10	8.69
227B10B	Oil R. Bronze	10	9.11
227B26D	Dull Chrome	10	9.46

KV BRASS FLUSH DRAWER PULL

Beveled edge brass flush drawer pull. 12/box with screws. 1-3/4" x 3-1/4" x 9/16" deep, with beveled edges.



819X

Code	Finish	Ctn	List/ea
819XPB	Pol. Brass	12 ea.	\$ 11.09
819XANO	Anochrome	12	10.14

BAINBRIDGE RECESSED PULL



1710-20WH

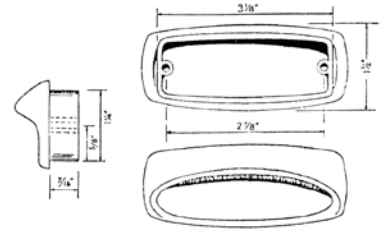

Recessed pull for all applications including lids, drawers, and doors. Plastic.

Size: 3-1/8" x 1-1/2" x 7/16" projection from mounting surface. With screws.

Code	Finish	Ctn	List/ea
1710-20BL	Black	100 ea.	\$ 2.59
1710-20WH	White	100	1.99

FLUSH MOUNT PLASTIC HANDLES

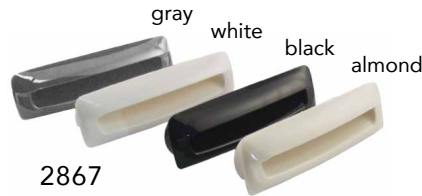

2867

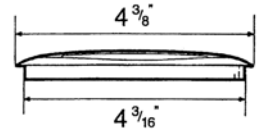
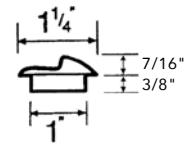

Screw C to C: 3-3/4"
260 per ctn.

Code	Finish	List/ea
2867-010	White	\$ 2.13
2867-014	Black	2.12
2867-020	Gray	1.88
2867-029	Almond	2.27

KV THREADED FINGER PULL

Two-piece screw-together pull for glass 3/16" to 15/16" thick. 1-1/16" OD rim. Drill 13/16" hole in glass. Anochrome finish.



836A

Code	Ctn	List/ea
836A	50 ea.	\$ 3.10



FLUSH PULLS

BALDWIN FLUSH RING PULLS

Solid Brass



No. 0392
1-1/4" x 1-1/2" x
5/8" ID Flat Top Ring

Code	Finish	List/ea
0392-030	Polished Brass	\$ 22.24
0392-102	Oil R. Bronze	22.24
0392-260	Polished Chrome	22.24
0392-264	Satin Chrome	22.24



No. 0393
1-5/8" x 1-5/8" x
5/8" Ring ID

Code	Finish	List/ea
0393-030	Polished Brass	\$ 22.24
0393-102	Oil R. Bronze	22.24
0393-260	Polished Chrome	22.24
0393-264	Satin Chrome	22.24



No. 0394
1-7/8" x 2-1/2" x
1" Ring ID

Code	Finish	List/ea
0394-030	Polished Brass	\$ 32.35
0394-102	Oil R. Bronze	32.35
0394-260	Polished Chrome	32.35
0394-264	Satin Chrome	32.35



No. 0395
2-1/2" x 3.3" x
1-1/2" Ring ID

Code	Finish	List/ea
0395-030	Polished Brass	\$ 41.45
0395-102	Oil R. Bronze	41.45
0395-260	Polished Chrome	41.45
0395-264	Satin Chrome	41.45

DELTANA FLUSH RING PULLS

Solid Brass



FRP175
1-3/4" x 1-3/8"



FRP25
2-1/2" x 1-7/8"

Code	Finish	Ctn.	List/ea
FRP175U3	Polished Brass	50 ea.	\$ 9.60
FRP175U15	Satin Nickel	50	11.68
FRP175U10B	Oil R Bronze	50	11.68
FRP25U3	Polished Brass	20	\$ 14.61
FRP25U15	Satin Nickel	20	18.93
FRP25U10B	Oil R Bronze	20	18.93

TYDIX FLUSH PULLS

TYDIX FLUSH PULLS

All Special Order

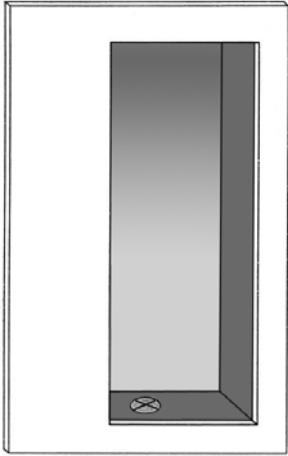

No. 61064 4" x 2-1/2"

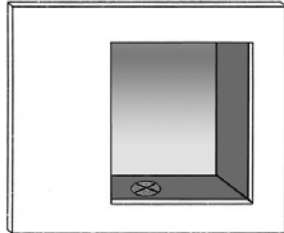

No. 61063 2" x 2-1/2"

SINGLE PULL FOR DOORS & DRAWERS

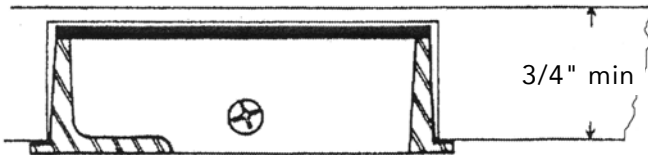

TWO PULLS -- ONE DOOR

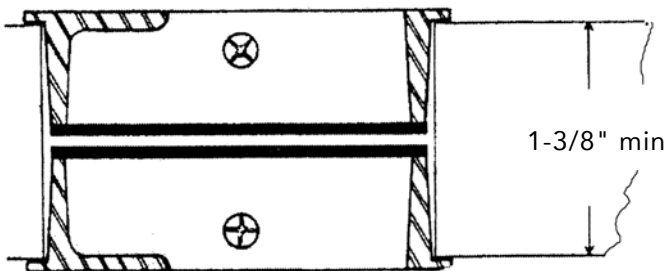

TYDIX FLUSH PULLS

All Special Order

TO ORDER, SPECIFY THE FOLLOWING:

1. Flush Pull Number
2. Finish of Face
3. Color Inside (Black is standard)
4. Backplate Color (Black is standard)

TAMPERPROOF SCREWS:

Specify "TMP" and add \$ 1.32 list

TYDIX FLUSH PULL PRICING

(Other Finishes are Available - Call for Price)

Code	Face Finish	Inside Finish	List/ea
61063 US3XBLK	Pol. Brass	Black	\$ 122.00
61063 US26XBLK	Pol. Chrome	Black	106.00
61063 US26DXBLK	Dull Chrome	Black	106.00
61063 US10BXBLK	Oil R. Bronze	Black	106.00
61064 US3XBLK	Pol. Brass	Black	136.00
61064 US26XBLK	Pol. Chrome	Black	130.00
61064 US26DXBLK	Dull Chrome	Black	130.00
61064 US10BXBLK	Oil R. Bronze	Black	130.00



BY-PASS DOOR HARDWARE

Hettich GRANT 6034 SERIES BY-PASSING DOOR TRACK - 50/75 LBS.

See pages 418, 450-451 for more Hettich/Grant Door Hardware

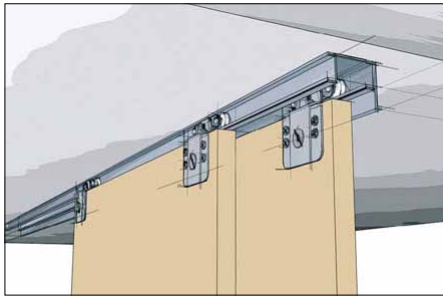

For Two 3/4" or 1-3/8" Doors

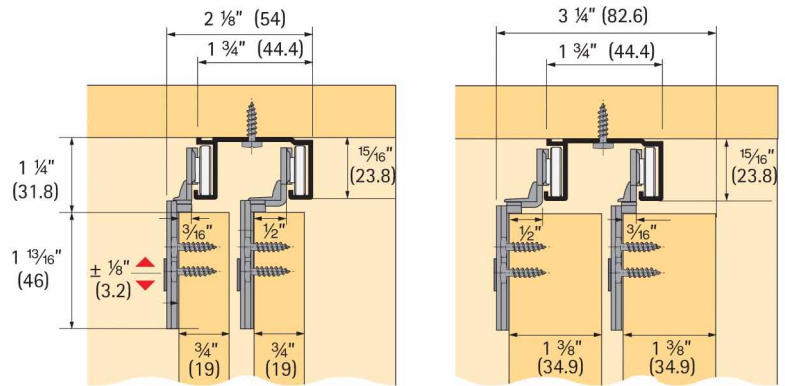

- Hangers can be reversed to fit either size door
- Adjusts 1/4" vertically, Headroom 1-1/8" - 1-3/8"
- For 3/4" and 1-3/8" Doors weighing up to 50 lbs/door with 6034 hdwr set, 75 lbs/door with 6064 hdwr set
- Ball-bearing wheels ensures a smooth, quiet and long lasting performance

- Dual set of mounting holes; ideal for hollow core doors
- Dust free track design
- Quick door hanging by tilting pre-mounted hardware onto track profile
- Floor guide required

6034 SERIES SEPARATE TRACK AND HARDWARE

Aluminum Double Track
For Two 3/4" or 1-3/8" Doors

Extruded aluminum track for by-passing doors.
1-3/4" wide, 15/16" high.



Code	Size	Ctn	List/ea
6004-4	4'	5 ea	\$ 23.42
6004-6	6'	5	25.86
6004-8	8'	5	29.00
6004-12	12'	5	39.56
6004-16	16'	5	55.31

HARDWARE SETS

6034 (50 lb.) Hardware set includes:

- (2) 6320 single wheel 3/16" offset carriers
- (2) 6330 single wheel 1/2" offset carriers
- (1) 114 Nylon double floor guide & screws/instructions



6064 (75 lb.) Hardware set includes:

- (2) 6350 double wheel 3/16" offset carriers
- (2) 6360 double wheel 1/2" offset carriers
- (1) 114 Nylon double floor guide & screws/instructions



Code	Description	Ctn	List/set
6034	50 lb. Hardware Set	10 ea.	\$ 17.58
6064	75 lb. Hardware Set	10	24.44

CARRIERS ONLY

As used in 6034/6064 hardware sets



Code	Description	Ctn	List/ea
6320	Carrier w/ 3/16" offset	50 ea.	\$ 3.75
6330	Carrier w/ 1/2" offset	50	3.76
6350	Double Wheel Carrier w/ 3/16" offset	50	5.42
6360GR	Double Wheel Carrier w/ 1/2" offset	50	5.42

FLOOR GUIDE

Fits into slot cut into bottom of sliding doors. Hidden from view.
Zinc plated zamak.



7015
3" x 7/8" x 3/4"

Code	Description	Ctn	List/ea
7015	Floor Guide w/slot	50 ea.	\$ 6.51

BY-PASS DOOR HARDWARE

BY-PASSING DOOR HARDWARE

For Two 1-3/8" Doors, 60 lbs. each

1 piece single wheel door hangers for light weight or hollow core doors. Each set contains: track, hanger, guides, and pulls. Galvanized steel double "J" tracks can be cut to size.

For two 1-3/8" doors up to 60 lbs. each.
10 sets per carton.



40-3006
46-1/2 Wide
For Two 2' Doors
List \$ 15.91 set

40-3008
58-1/2 Wide
For Two 2'6" Doors
List \$ 16.74 set

40-3010
70-1/2 Wide
For Two 3' Doors
List \$ 20.13 set

40-3012
93-1/2 Wide
For Two 4' Doors
List \$ 24.63 set

EASY ADJUSTMENT

Simply insert screwdriver in hanger slot and turn to adjust for plumb. Doors hold position when screws are loose to eliminate shimming.



Steel Track

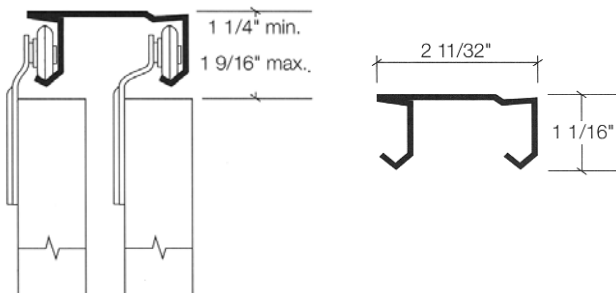

REPLACEMENT HANGERS



Code	Finish	Size	Ctn	List/pr
54-1268	Alum.	1/4" Offset	50 pr.	\$ 2.14
54-1284	Alum.	1/2" Offset	50	2.37

BY-PASSING DOOR HARDWARE

For Two 3/4" or 1-3/8" Doors, 60 lbs. each

For two 3/4" or 1-3/8" by-passing doors weighing up to 60 lbs. each. Set contains:
1 aluminum track,
1 pr. 8901 hangers and
1 pr. 8902 hangers, 1 floor guide, 2 pulls, screws and instructions.



10 sets per package.

Code	Description	List/st
40-3020	Set for two 2' Doors	\$ 23.66
40-3021	Set for two 2' 6" Doors	25.96
40-3022	Set for two 3' Doors	30.47

TRACK ONLY Aluminum double 'J' track

Code	Size	Ctn	List/ea
54-1232	46"	10 ea	\$ 12.05
54-1236	58"	10	14.68
54-1240	70-3/8"	10	18.06
54-1264	144"	10	34.82

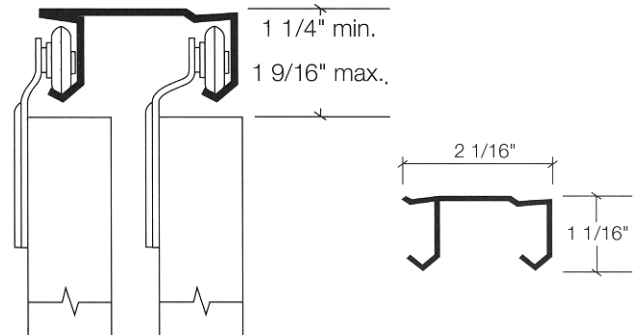

SINGLE WHEEL HANGER SET

Includes 1 pr. 8901, 1 pr. 8902, 1 ea. floor guide, 2 pulls, screws and instructions.

Code	Ctn	List/st
54-1252	10 sets/box	\$ 5.94

SLIDING DOOR HARDWARE

HEAVY DUTY BY-PASSING DOOR HARDWARE

For installation of 2 By-Passing doors, with 1-3/8" to 1-3/4" thick panels. 150 lb. and 250 lb. capacities available.

4 ALUMINUM SINGLE TRACK

Use 2 tracks per by-passing set. 6', 8', 10', 12' and 16' lengths available. Order hardware sets separately.

1 per Ctn.

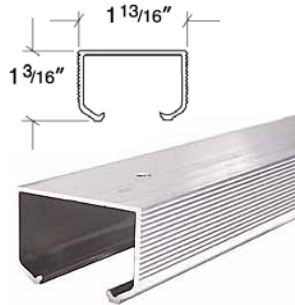

DOOR CARRIER SETS - 150 lb or 250 lb

For 150 lb set:

2 each Tracks
1 set 40-5860 Hardware Set



40-5860 Hardware set includes : 4 ea. 4-wheel carriers, door plates, floor guide, wrench, and screws.

For 250 lb set:

2 each Tracks
2 sets 64690 Hangers
1 ea. 40-3534 Floor Guide



40-3534 Adj. Floor Guide
1-3/8" to 1-3/4"

Track	Length	List
40-5104	72"	\$ 21.61
40-5105	96"	28.15
40-5106	120"	34.12
40-5107	144"	37.74
40-5108	192"	49.54

150 lb. Hardware Set	Ctn	List
40-5860	10 sets	\$ 31.32/set

250 lb. Hardware	Ctn	List
64690 Top Hangers	1 pr	\$ 24.65 /st
40-3534 Floor Guide	10 ea	6.82 /ea

Features

- Large 1" wheels provide smooth rolling action
- Easy-to-install snap-in feature makes hangers a "snap" to install
- Vertical adjustments can be made after installation
- Supports panels weighing up to 150 or 250 lbs
- Durable V-groove aluminum track provides smooth, quiet operation
- Track spacer allows for easy installation of bypass and tripass doors

INSTALLATION DETAIL

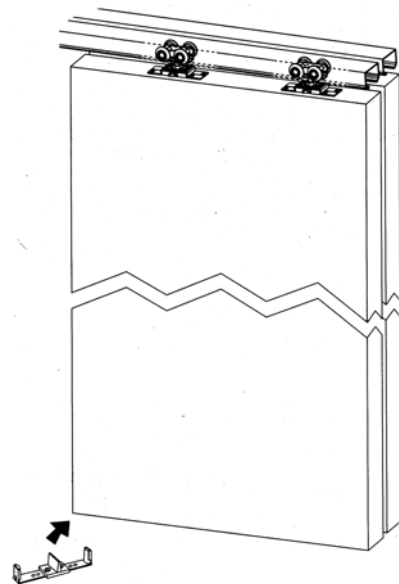

1 3/4" Doors

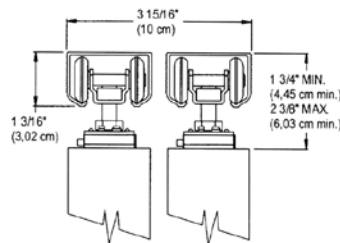

1 3/8" Doors

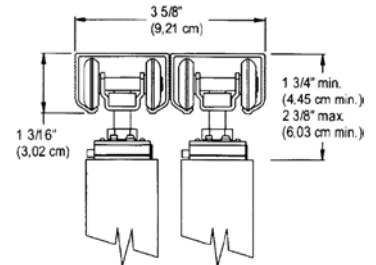

NOTE: Door height should be 2-5/8" less than finished opening height

Cross Reference

Stanley 1700 • Cox 15 • Crowder C-500 • Grant 7000 • Hager 9702 • Henderson W Series • Johnson 134F/18F • Sterling 1602

SLIDING DOOR PARTS

4

No. 40-5302

Heavy Duty Pivot Set:

Includes top and bottom pivots, wrench, screws, and instructions. Bottom pivot has ball-bearing raceway. Fits into 1-3/4" deep, 3/8" diameter hole in door.



40-5301

No. 40-5301 Four Wheel Hanger:

125 lb. load capacity. For 1-1/8" to 1-3/4" doors.



52-2612



52-2620

No. 52-2612 Top Pivot:

Spring-loaded, mounts in pivot and guide doors

No. 52-2620 Top Guide Wheel:

Spring-loaded and self-adjusting, mounts in guide doors.

No. 40-0004 Center Stop:

Attaches to track to limit panel travel. 1-5/8" L x 1-3/16" W



No. 52-2232 Adjusting Wrench:



No. 52-2236 Top Pivot Bracket:



40-3993



40-3997

No. 40-3993 Pocket Door Guide:

Adjusts to center door in pocket for 1-3/8" door.

No. 40-3997 Pocket Door Guide:

Adjusts to center door in pocket for 1-3/4" door.

No. 40-2309 Guide Roller:

Adjustable high performance lubricated thermoplastic guide. 7/16 dia. shank



40-2309



54-1008



54-1016

No. 54-1008 Floor Guide:

Adjustable for 3/4" to 1-3/8" thick by-passing doors.

No. 54-1016 Carpet Riser:

For mounting 54-1008 guide over carpeted floor. 1/2 Rise.

PARTS PRICE LIST

<u>Code</u>	<u>Description</u>	<u>Ctn</u>	<u>List</u>
40-0004	Center Stop	20 ea.	\$ 4.37/ea
40-2309	Guide Roller	10 ea.	4.00/ea
40-3993	P Door Guide, 1-3/8"	50 ea.	2.89/ea
40-3997	P Door Guide, 1-3/4"	50 ea.	5.90/ea
40-5301	Bi-Fold Hanger, 4 Wh	10 ea.	27.30/ea
40-5302	Bi-Fold Pivot Set	10 set	36.37/st
52-2232	Adjusting wrench	400 ea.	.39/ea
52-2236	Top Pivot Bracket	200 ea.	.70/ea
52-2612	Top Pivot	200 ea.	.51/ea
52-2620	Top Guide Wheel	200 ea.	.73/ea
54-1008	Floor Guide	50 ea.	1.74/ea
54-1016	Carpet Riser	50 ea.	1.37/ea

BI-FOLD DOOR HARDWARE

STANLEY BI-FOLD DOOR HARDWARE

Load Cap: 30 lb. per panel



4

"Fold-Aside" Bi-Fold Door Hardware for 7/8" to 1-3/8" Hollow Core or Louver Doors to 8' High and 30 lbs. each.

For 2 and 4 Door Installations.

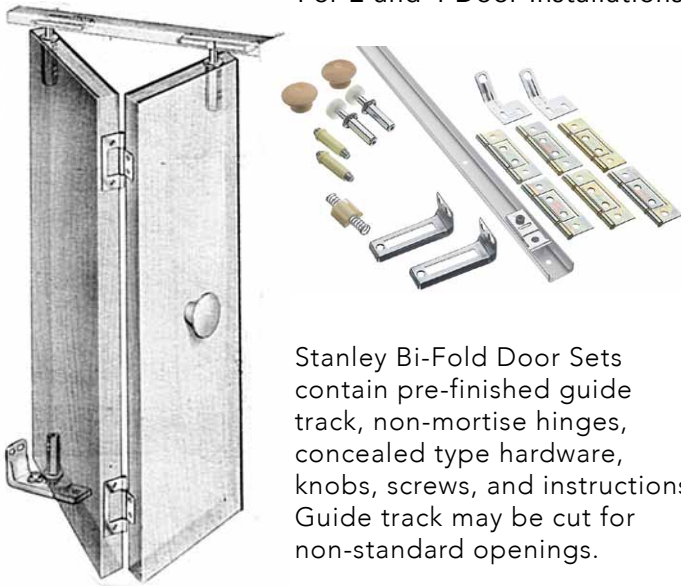

Stanley Bi-Fold Door Sets contain pre-finished guide track, non-mortise hinges, concealed type hardware, knobs, screws, and instructions. Guide track may be cut for non-standard openings.

Features:

- Spring loaded top pivot and roller guide for easy installation
- Permanently lubricated roller guide
- Durable pre-painted track
- All metal components galvanized against corrosion

Code	Size	Doors	Ctn	List/set
40-2032	36"	2	10 sets	\$ 28.00
40-2044	48"	4	10	38.92
40-2054	60"	4	10	41.84
40-2064	72"	4	10	44.10

Cross Reference

Stanley 2400/2900 SERIES • Cox 43/48 Crowder CF-100

- Grant 2600 SERIES Hendsen B Series
- Johnson 1800 • Sterling 9000

INSTALLATION DETAIL

For installation of 2 or 4 panels, 7/8" to 1-3/8" thick weighing up to 30 lbs each.

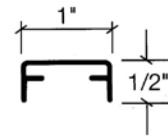
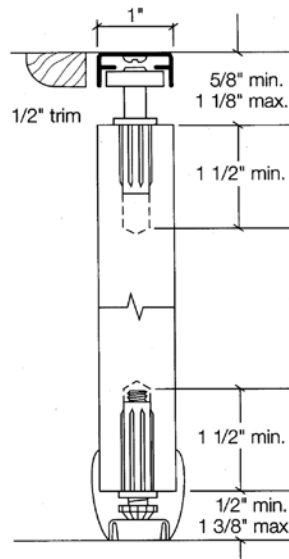
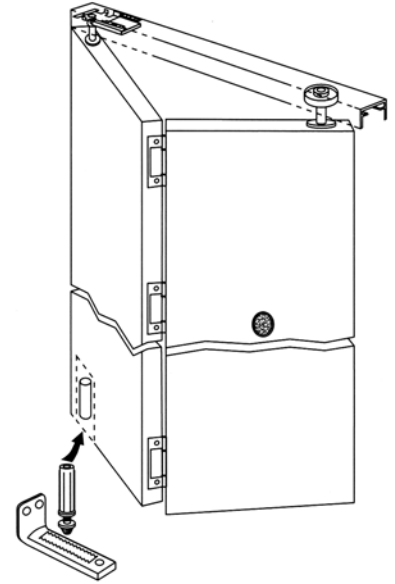

Dimpled stop to limit opening of door travel

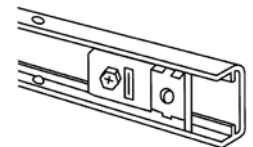

NON-MORTISE HINGE FOR BI-FOLD DOORS

9220

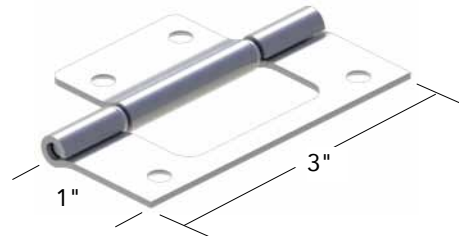

Non-mortise Hinge, Steel w/ bright zinc finish, packed w/ screws.

Code	Ctn	List/ea
9220	100 ea	\$ 2.38

BI-FOLD DOOR HARDWARE

CUSTOM FOLD-A-SIDE AND ACCORDIAN DOOR HDW - 50 LB.

For 1" to 1-3/8" Folding Doors up to 50 lbs. ea. (max. two doors to a jamb)
For 1" to 1-3/8" Accordion Doors up to 30 lbs. ea. (more than two doors to a jamb)

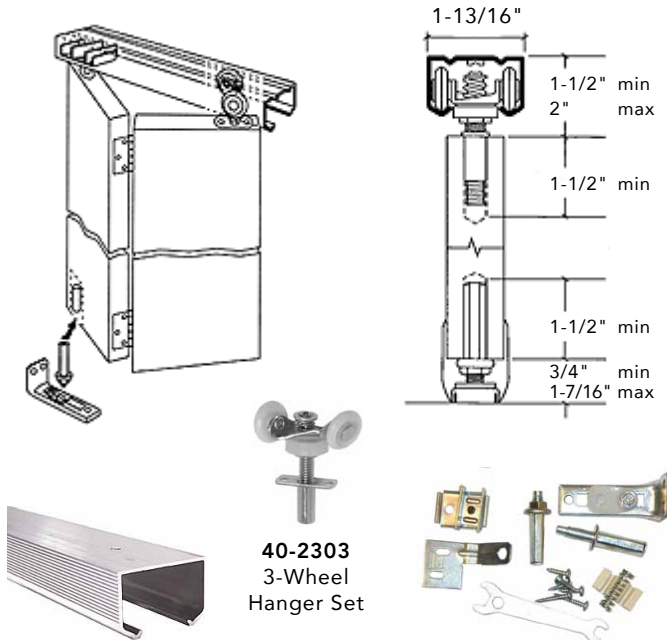

Jump Proof Aluminum Track:
Track has slots at four foot intervals for inserting hangers without having to cut track short of opening

Pack: 10 ea.

Code	Description	List/ea
40-2321	4' track	\$ 17.35
40-2322	5' track	22.31
40-2323	6' track	25.11
40-2324	8' track	41.65
40-2326	10' track	46.95
40-2308	Pivot Set	7.03
40-2303	Hanger	9.35

Ordering Guide

● Pivot Hardware
○ Hangers

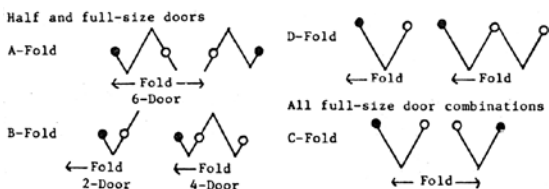

Cross Reference: Stanley 2600, Crowder CF-115, Henderson HF-N

BI-FOLD DOOR PARTS



PARTS FOR THE BI-FOLD 30 LB SERIES

Code	Description	Ctn	List
52-2224	Surface Aligner	100	.89
52-2252	Jamb Mtg. Bracket, Alum	200	1.49
52-2272	Top Pivot, 7/16" Hole	200	.76
52-2276	Bottom Pivot, 7/16" Hole	200	1.24
52-2280	Top Guide Wheel 7/16" Hole	200	1.39
52-2372	Slide Guide	200	.73
52-4200	Jamb Mtg. Bracket	200	.73
52-3248	Bottom Pivot	200	1.49

PARTS FOR THE BI-FOLD 50 LB SERIES

52-2252	Jamb Mtg. Bracket	200	1.49
52-2272	Top Pivot, 7-16" hole	200	.76
52-2276	Bottom Pivot, 7/16" Hole	200	1.24

BI-FOLD DOOR PARTS

Hettich

GUIDE ROLLER



Steel plate, 3/4" x 2".
Fasten to door bottom.
1/2" dia. roller rides in guide channel.

Use with # 1222 Channel

Code	Ctn	List/ea
1211	20 ea.	\$ 3.96

ALUMINUM GUIDE CHANNEL



Can be surface mounted or mortised into floor.
3/4" x 5/8" high, 3/32" thick.

Code	Ctn	List/ea
1222-8	5 ea.	\$ 30.86
1222-10	5	38.88
1222-12	5	46.31

BI-FOLD DOOR HARDWARE

HEAVY DUTY BI-FOLD DOOR HARDWARE

Load Cap: 125 lb. per panel

4

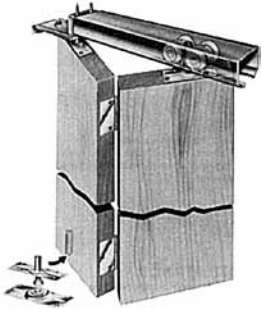

Order:
1 ea. Track
1 ea. 40-5301 Hanger Set
per pair of doors
1 ea. 40-5302 Pivot set

For installation of 2 panels weighing up to 125 lbs. each or multi-panels weighing up to 75 lbs. each, 1-1/8" to 1-3/4" thick. For thicker panels, consult factory.



Aluminum Single Track:
6', 8', 10', 12'



Four Wheel Hanger Set:
For 1-1/8" to 1-3/4" doors.

No. 40-5302 Heavy Duty Pivot Set:
Includes top and bottom pivots, wrench, screws, and instructions. Bottom pivot has ball-bearing raceway. Fits into 1-3/4" deep, 3/8" diameter hole in door.



Code	Description	Ctn	List
40-5104	72" Track	1 ea.	\$ 21.61
40-5105	96" Track	1 ea.	28.15
40-5106	120" Track	1 ea.	34.12
40-5107	144" Track	1 ea.	37.74
40-5301	Bi-Fold Hanger, 4 Wh	10 ea.	\$ 27.30
40-5302	Bi-Fold Pivot Set	10 sets	36.37

NOTE: Door height should be 2-3/4" less than the opening height.

Features:

- Large wheels provide smooth action
- Easy-to-install snap-in feature makes hangers a "snap" to install
- Durable V-groove aluminum track provides smooth, quiet operation
- All metal components zinc plate to guard against corrosion
- Heavy Duty pivot set designed for durability and aesthetics

INSTALLATION DETAIL

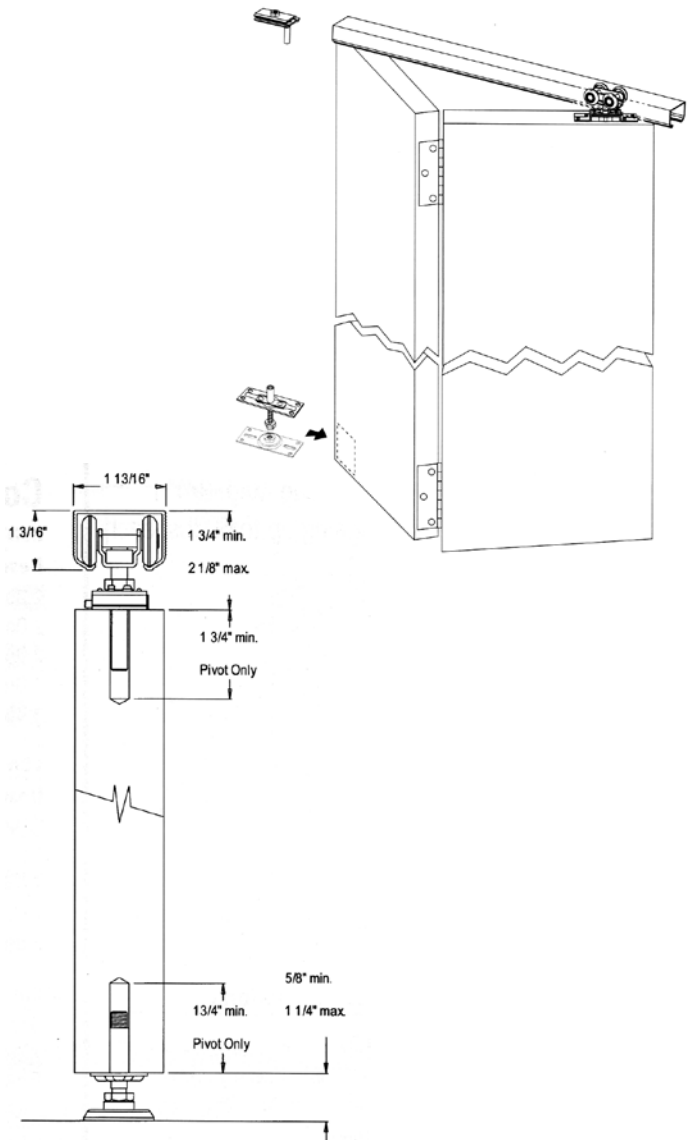

Cross Reference

STANLEY 2700 • Cox 42-200 • Henderson 301H



POCKET DOOR TRACK

STANLEY POCKET DOOR TRACK SET

Load Cap: 75 lbs.



Set contains:

1 ea. 6' steel track,
1 pr. top mount
hangers, Nylon
door guides, door
bumper, 1 ea.
wrench, screws &
instructions.

6 sets per pack.

- For installation of one sliding pocket or along-the-wall door weighing up to 75 lbs.; 3/4" to 1-3/4" thick
- Pre-finished v-shaped track is jump-proof
- Adjust-n-lock, permanently lubricated, 2-wheel hangers provide up to 5/8" vertical adjustment and locks in one easy motion. Provides smooth and quiet operation
- Self-aligning wheel system

Code	Ctn	List/set
40-3903	6 sets	\$ 35.42

See pages 450-451 for more Hettich/Grant Door Hardware

1260 Bi-Fold - 175 lbs/door	(pg 450)
1210 Sliding Door - 225 lbs/door	(pg 450)
1230 Sliding Door - 325 lbs/door	(pg 450)
7000 By-Passing - 150 lbs/door	(pg 451)

GRANT SINGLE DOOR/ POCKET DOOR TRACK & HARDWARE
Hardware for Doors up to 150 lbs.

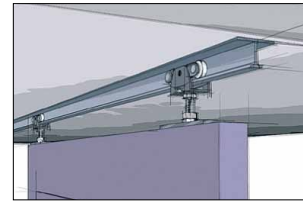

Adjustable top mount for door thickness of 3/4" and up. Order track and hardware separately.

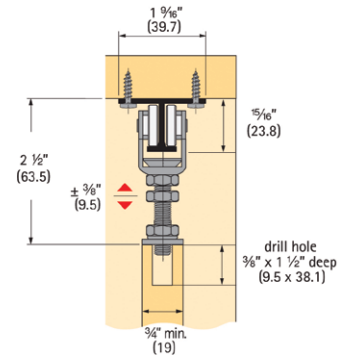

- Top mounting with 3/4" vertical adjustment
- Headroom: 2-1/8" min, 2-7/8" max
- Extruded aluminum "1" beam track, jump proof design
- Precision ball-bearing rollers, nylon floor guide

7001 Extruded Aluminum Track

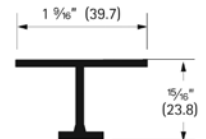

71-222 Hardware set includes: Two carriers with ball bearing wheels, two top plates with adjustable pendant bolts, one pair of floor guides, one wrench, necessary screws and installation instructions.

Accessories



7000 Nylon carrier, steel, up to 100 lbs/door (not included in set)



7222 Top Plate w/ pendant bolt, adjustable



7000-15 Ball-bearing carrier, up to 150 lbs/door



110 Nylon floor guide (pr)

Code	Description	Ctn	List
7001-6	6' Track	5	\$ 31.88/ea
7001-8	8' Track	5	38.97
71-222	Hardware Set	10	65.81/st
7000-100	Carrier, 100 lbs.	100	7.26/ea
7000-150	Carrier, 150 lbs.	100	21.39
7222	Top Plate	50	6.07
50101	Floor Guide	50	2.80/pr

POCKET DOOR TRACK

POCKET DOOR TRACK

Load Cap: 150 lb. per panel

150 lb Capacity for 1" to 1- 3/4" Doors

For each Pocket Door order:

- 1 ea. Track
- 1 ea. 40-5845 Hardware Set

Features:

- Four Large 1" wheels for easy rolling action
- Easy-to-install feature makes installation a "snap"
- Easy adjustment after installation
- Cut marks on header make for easy sizing
- V-groove jump proof track

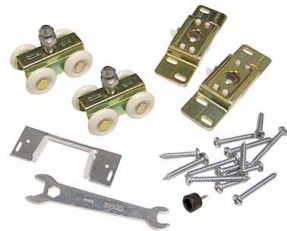

Aluminum Single Track

- Deep V-groove twin channel is jump proof
- 4', 5', 6', 8', 10', 12' lengths
- 1-3/16" H x 1-13/16" W

Hardware Set 40-5845

Consists of two 4-wheel hangers, 1 door guide, and 1 wrench.

Order Track and Hardware Set Separately

Track	Length	Ctn	List/ea
40-5109	48"	10 ea.	\$ 13.73
40-5111	60"	10	17.78
40-5113	72"	10	18.14
40-5114	96"	10	26.81
40-5106	120"	10	34.12
40-5107	144"	10	37.74

Hardware Set	Ctn	List/st
40-5845	10 sts.	\$ 14.45

INSTALLATION DETAIL

For installation of pocket or bi-parting doors, with 1" to 1-3/4" thick panels weighing up to 150 lbs. each.

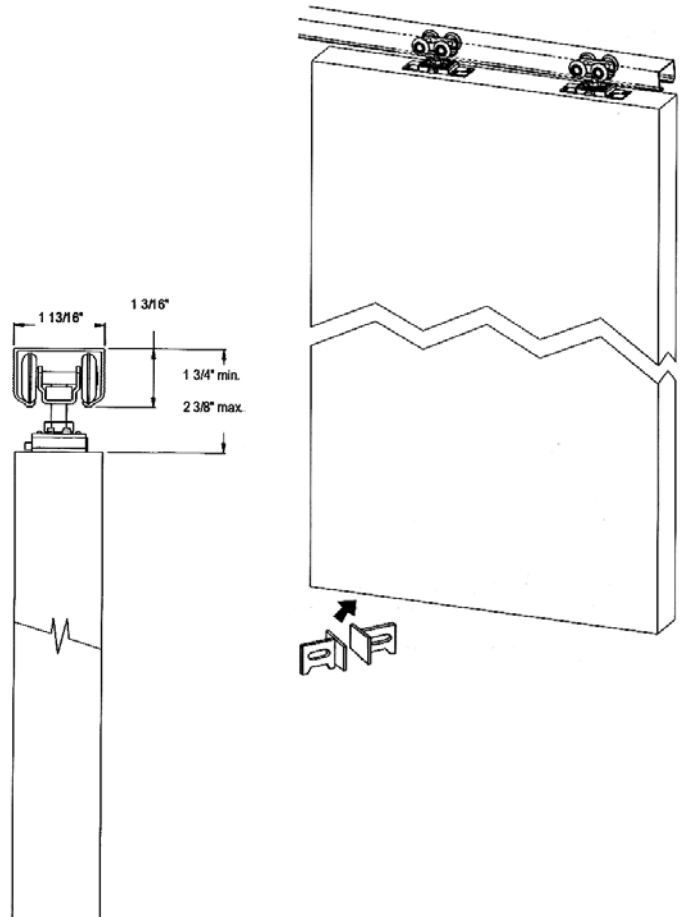

Cross Reference

Stanley 1750 • Cox 15-200 • Grant 7000 series
Hager 9601/9701 • Johnson 100/111
Lawrence 506/580 track

POCKET DOOR TRACK

HEAVY DUTY POCKET DOOR TRACK

Load Cap: 250 lb. per panel

250 lb. Capacity for 1-1/8" to 1- 3/4" Doors

For use on unusually heavy doors and in institutional installations where the very finest operation is desired. Ideal for moving space dividers, panels, and multiple doors. For doors 1-1/8" thick or more.

For each Pocket Door order:
1 ea. Track
1 pr. 64690 Hangers
1ea. Door Guide:
40-3993 for 1-3/8"
40-3997 for 1-3/4"



Top Mounting Hangers
64690 - 1 pair (2 each)
4 wheel hangers

Aluminum Single Track

- Deep V-groove twin channel is jump proof
- 6', 8', 10', 12' lengths
- 1-3/16" H x 1-13/16" W



Door Guide
40-3993 for 1-3/8"
40-3997 for 1-3/4"

Order Track and Hardware Set Separately

Track	Length	Ctn	List/ea
40-5104	72"	1 ea.	\$ 21.61
40-5105	96"	1	28.15
40-5106	120"	1	34.12
40-5107	144"	1	37.74

Hardware	Description	Ctn	List
64690	Top Mounting Hangers	1 pr	\$ 24.65/st
40-3993	Door Guide, 1-3/8"	50 ea	2.89/ea
40-3997	Door Guide, 1-3/4"	50 ea	5.90/ea

NOTE: Door height should be 2-5/8" less than the finished opening.

Features:

- Four large 1" wheels for easy rolling action
- Easy-to-install feature makes installation a snap
- Supports panels weighing up to 250 pounds
- Easy adjustment after installation
- Cut marks on header make for easy sizing
- V-groove jump proof track

INSTALLATION DETAIL

For installation of pocket or bi-parting doors up to 4' wide, weighing up to 250 lbs. each and up to 8' high.

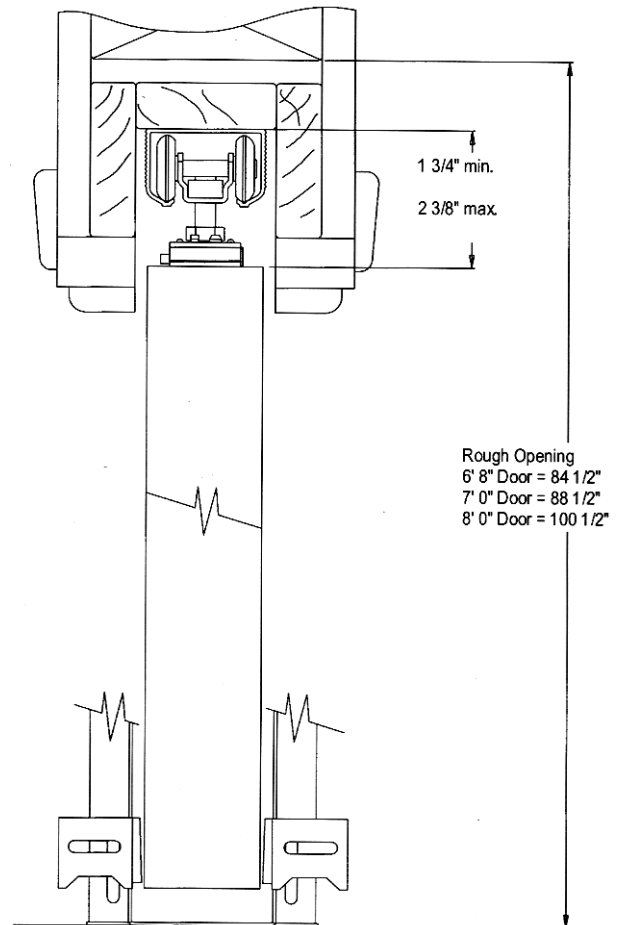

Cross Reference

- Stanley 735/40-3925R/40-3940
- Crowder Crowderframe • Hager 9630/9631
- Johnson 1500 • Sterling 1630

JOHNSON BYPASS DOOR HARDWARE



1166 Series - Bypass Door

Bypass Track and Hardware for 3/4" or 1-3/8" doors up to 50 lbs.

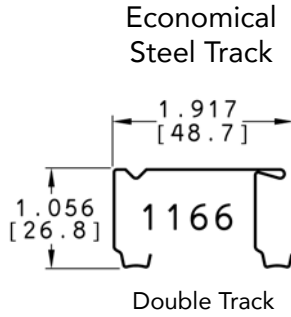
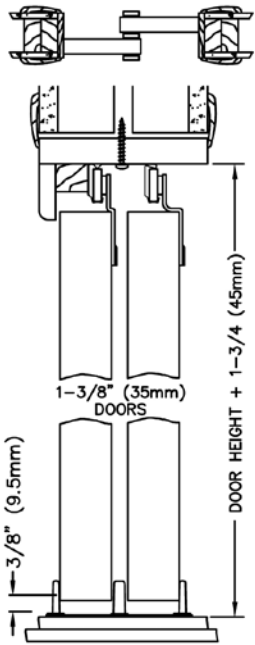

2200 Series - Bypass Door

Bypass Track and Hardware for 3/4" or 1-3/8" doors up to 50 lbs.

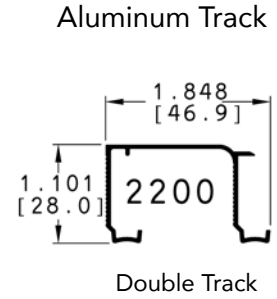
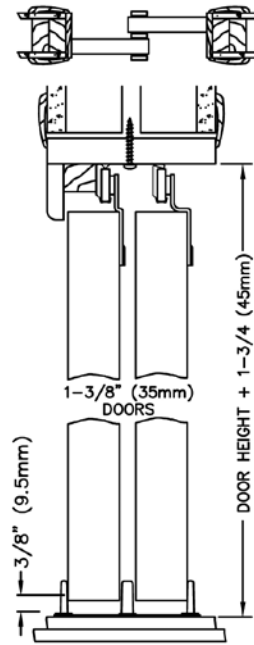

A gold colored steel bypass track. Convex track rails provide one point contact between wheel and track. One wheel (7/8" dia.) hangers with three point locking. One inch high woodtone adjustable door guide. Brass-tone steel parts. Ref. Stanley 40-3000 Series.

Aluminum bypass track for quiet, smooth operation. One wheel (7/8" dia.) hangers with three point locking. Convex track for single point wheel contact. One inch high woodtone adjustable door guide. Brass-tone steel parts. Ref. Stanley 54-1200 Series.

	Track	Description	List/ea
	1166-0048	48" - 2 doors	\$ 8.28
	1166-0060	60" - 2 doors	10.26
	1166-0072	72" - 2 doors	12.22
	1166-0096	96" - 4 doors	16.51

	Track	Description	List/ea
	2200-0048	48" - 2 doors	\$ 9.58
	2200-0060	60" - 2 doors	11.88
	2200-0072	72" - 2 doors	14.14
	2200-0096	96" - 4 doors	19.25

Bypass Hardware Set



Includes: hangers, guide and pulls. Each set is for 2 doors.

Code	Description	List/set
22310002	Bypass Hardware Set	\$ 5.77

Bypass Hardware Set



Includes: hangers, guide and pulls. Each set is for 2 doors.

Code	Description	List/set
22310002	Bypass Hardware Set	\$ 5.77

Extra Floor Guides

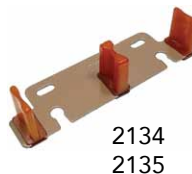

Code	Description	List/ea
2134	For 1-1/8" OR 1-3/4" doors	\$ 2.02
2135	For 3/4" OR 1-3/8" doors	.95

Extra Floor Guides



Code	Description	List/ea
2134	For 1-1/8" OR 1-3/4" doors	\$ 2.02
2135	For 3/4" OR 1-3/8" doors	.95

BYPASS DOORS



BI-FOLD DOORS

100SD Series - Bypass

Heavy Duty Bypass Track and Hardware for 1" or Thicker Doors up to 200 lbs.

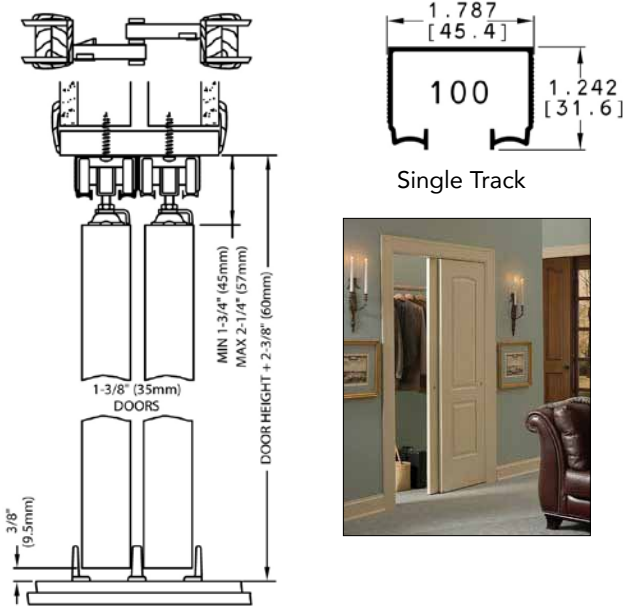

100FD Series - Bifold

Top Mounted Bifold Hardware for 1"- 1-3/4" Thick Panels up to 75 lbs.

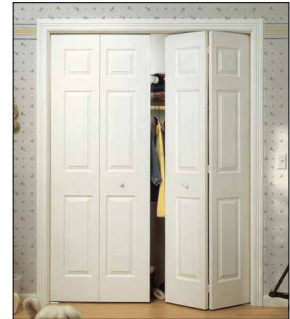
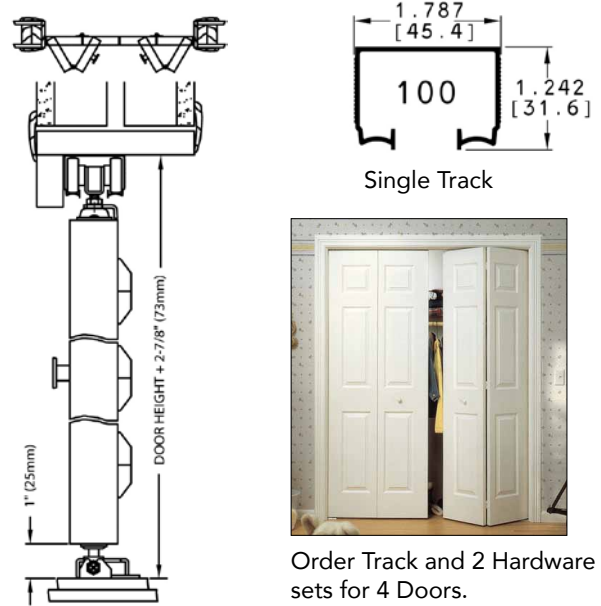

Order Track and 2 Hardware sets for 4 Doors.

Commercial Bypass sliding door hardware set for doors weighing up to 200 lbs. each. Heavy-duty extruded aluminum box track utilizes three-wheeled ball bearing rollers (#1125) with 1" dia. machine turned wheels. Door guide is adjustable for different thicknesses of doors. (min door thickness is 1") Ref. Stanley 40-5100 Series.

Commercial Bifold Hardware set for 12" - 24" panels up to 9' high weighing 75 lbs each. Convex rail aluminum track with positive pivot lock, top hung, three wheel (1" dia) ball bearing hangers and non-mortise lift off hinges. Floor bracket has a screw adjusting bottom pivot socket. Brass-tone steel parts. Ref. Stanley 40-5300 Series.

	Track	Opening	Ctn	List/ea
		Size		
	100-0060	60"	25	\$ 15.40
	100-0072	72"	25	18.17
	100-0096	96"	10	24.59
	100-0144	144"	10	38.07

	Track	Opening	Ctn	List/ea
		Size		
	100-0060	60"	25	\$ 15.40
	100-0072	72"	25	18.17
	100-0096	96"	10	24.59
	100-0144	144"	10	38.07

Bypass Hardware Set



Includes: hangers, guide, stop, pull and wrench. Each set is for 2 doors.

Code	Description	List/set
10311012	Bypass Hardware Set	\$ 50.17

Bifold Hardware Set



Includes: pivots, stop, hinges, knob, hangers, wrench and aligner. Each set is for 2 door bifold.

Code	Description	List/set
1031FD02	Bifold Hardware Set	\$ 31.33

Spare Parts

101U
Universal
Floor Guide

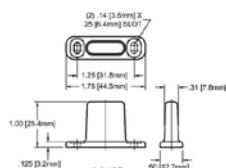

Code	Description	List/ea
101U	Floor Guide (3/4" - 2-1/4" doors)	\$ 1.45

Spare Parts (Already included in Hardware Set)

Code	Description	List
109PIV-S	Pivot Set (1 set)	\$ 10.79/st
1606	Bifold hinges (1 pr)	2.86/pr
1808	Aligner (1 set)	.61/st

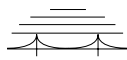

POCKET DOORS

100PD Series - Pocket Door

Commercial Grade Pocket Door Hardware for 1" or Thicker Door up to **125 lbs.** (200 lbs. with #10311005 set)

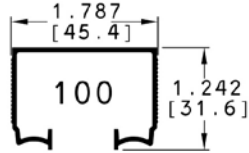
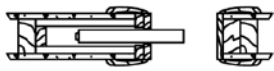

Single Track

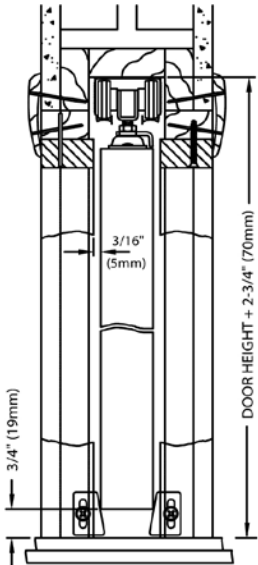

Can be used for pocket doors or in combination with itself to make special installations of sliding doors. Aluminum track with convex rails, jump proof three wheel (1" dia.) hangers assure a smooth, quiet operation. Brass-tone steel parts. Ref. Stanley 40-5100 Series.



Track	Opening Size	Ctn	List/ea
100-0060	60"	25	\$ 15.40
100-0072	72"	25	18.17
100-0096	96"	10	24.59
100-0144	144"	10	38.07



10311002

Pocket Door Hardware Sets

Includes: hangers, guide, bumper and wrench. For one door.

Pack: 25 sets



10311005

Code	Description	List/set
10311002	Hardware Set, 125 lb. door	\$ 9.39
10311005	Hardware Set, 200 lb. door	22.26

BARN DOOR SETS

2610F Series - Barn Door Track

Wall Mounted Fascia Track and Hardware for 1" to 1-3/4" Thick Door up to **125 lbs.** (200 lbs. with #26311005 set)

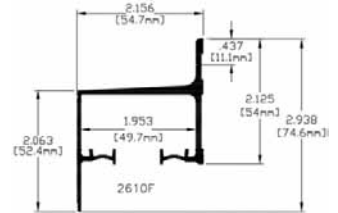

Single Track w/Fascia

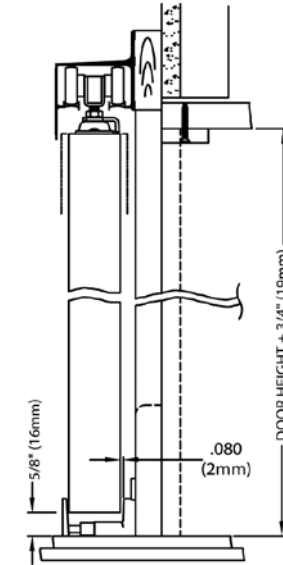

Surface mounted hardware set for open pocket doors. Use to slide a door along the wall rather than in the wall. Aluminum track with convex rails, jump proof three wheel (1" dia.) hangers assure a smooth, quiet operation. Also includes a wall-mounted door guide. Brass-tone steel parts.



Track	Description	List/ea
2610F-0072	72", for one 3'0" door	\$ 47.43
2610F-0096	96", for one 4'0" door	62.80
2610F-0144	144" length track	94.05



26311003

Barn Door Hardware Sets

Includes: 2 hangers, 2 stops, 1 guide, 2 end caps and wrench. For one door.



26311005

Code	Description	List/set
26311003	Hardware Set, 125 lb. door	\$ 14.34
26311005	Hardware Set, 200 lb. door	27.14

Cross Reference

Johnson • Stanley • Grant

4

Johnson	Stanley	Grant
By-Passing, Steel Track & Hardware		
1166-0048 (track)	40-3006, BPC60-00-48 (track)	
1166-0060 (track)	40-3008, BPC60-00-60 (track)	
1166-0072 (track)	40-3010, BPC60-00-72 (track)	
1166-0096 (track)	40-3012, BPC60-00-96 (track)	
22310002 (hdwe set)	54-1252, BP60-HDW-3 (hdw set)	
By-Passing, Aluminum Track & Hardware		
2200-0048 (track)	54-1232, BPC60A-00-48 (track)	6004-4
2200-0060 (track)	54-1236, BPC60A-00-60 (track)	6004-6
2200-0072 (track)	54-1240, BPC60A-00-72 (track)	6004-8
2200-0096 (track)	54-1264, BPC60A-00-96 (track)	6004-12
22310002 (hdwe set)	54-1252, BP60-HDW-3 (hdw set)	6034/6064 (50-75 lb)
Heavy Duty, By-Pass Track & Hardware		
100-0060 (track)	-	
100-0072 (track)	40-5104 (track)	7003-6
100-0096 (track)	40-5105 (track)	1201-8 7003-8
100-0144 (track)	40-5107 (track)	1201-12 7003-12
10311012 (hdw set)	150 lb. hdw set = 40-5860 250 lb. hdw set = 64690 (hangers) + 40-3534 (floor guide)	1210 (225 lb) 1230 (325 lb) 72-138/134 (150 lb)
Bi-Fold Track & Hardware		
100-0060 (track) (75 lbs/door, 2 doors)	40-2322 (track) (50 lbs/door, 2 doors)	
100-0072 (track) (75 lbs/door, 2 doors)	40-2323 (track) (50 lbs/door, 2 doors)	
100-0096 (track) (75 lbs/door, 2 doors)	40-2324 (track) (50 lbs/door, 2 doors)	1201-8
100-0144 (track) (75 lbs/door, 2 doors)	-	1201-12
1031FD02 (Bi-Fold hdw set)	40-2308 (pivots) + 40-2303 (hangers)	1260 (175 lb)
Pocket Door Hardware		
100-0060 (track)	-	
100-0072 (track)	40-5104 (track)	7001-6
100-0096 (track)	40-5105 (track)	7001-8
100-0144 (track)	40-5107 (track)	
10311002 (125 lb. hdw set) or 10311005 (200 lb. hdw set)	64690 (top hangers) plus 40-3993 (1-3/8" door guide) or 40-3997 (1-3/4" door guide)	71-222

CABINET SLIDING SYSTEM

DUCASSE

CABINET SLIDING SYSTEM
AL 1535 for 2 Wood Doors

- Load Capacity: **33 lbs/door**, ANSI-BHMA, Grade 1
- 2 panels can be installed left or right. 2 sets installed in opposite directions can close an opening up to 10'.
- Ball bearing quality rollers for a silent, smooth glide
- Min door thickness: 5/8" wood

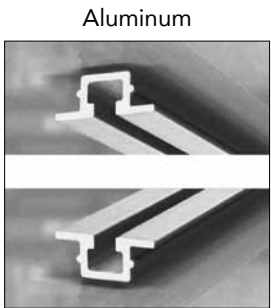

Carrier Track CXE
Flush mount top/bottom



Carrier
AL 1535 Wood

AL 1535 for Wood Doors
set for 2 doors

- A** 4 Carriers AL1535 
- B** 4 Top guides with clip device 
- C** 4 Stoppers with retention device 
- D** Screws 

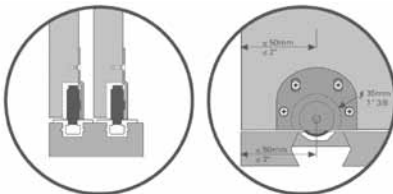

Carrier Installation
35mm edge bore

Code	Description	List
012103	AL 1535 for Wood Doors, Set for 2 Doors	\$ 33.97
021CXE1	CXE Inset AL 1535, 6.5'	10.11
021CXE2	CXE Inset AL 1535, 9.85'	17.40

CABINET SLIDING SYSTEM
AL 1535 for 2 Glass Doors

- Load Capacity: **33 lbs/door**, ANSI-BHMA, Grade 1
- Clip on upper guide allows for easy mount and dismount of door
- Anodized aluminum track flush mounted for a concealed clean look

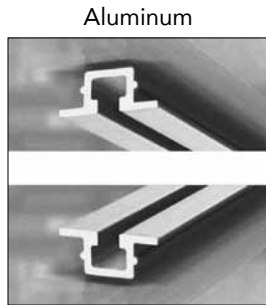





Carrier Track CXE
Flush mount top/bottom



Carrier AL 1535 Glass

AL 1535 for Glass Doors
set for 2 doors

- A** 4 Carriers AL1535 
- B** 4 Top guides w/ clip device 
- C** 8 Finishing caps 
- D** 4 Stoppers with retention device 
- E** Screws 

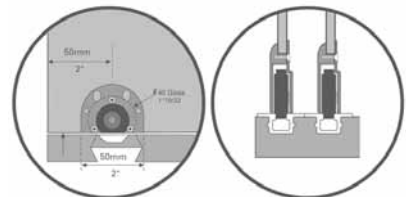

Carrier
Installation

Code	Description	List
012102	AL 1535 for Glass Doors, Set for 2 Doors	\$ 36.40
021CXE1	CXE Inset AL 1535, 6.5'	10.11
021CXE2	CXE Inset AL 1535, 9.85'	17.40

4

DUCASSE

FLOOR SLIDING SYSTEM

FURNITURE FLOOR SLIDING
D 25 Floor Sliding System for Wood Doors

- Load capacity: **33 lbs/door**
- Ball bearing quality rollers for a silent and smooth glide
- Min door thickness: 5/8"



Track D 25 PVC
Available in Four Colors



D 25
carrier set
for 2 doors

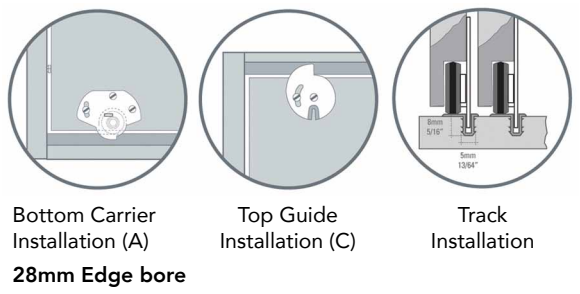

Code	Description	List
012101	D 25 Hardware Kit for 2 Doors	\$ 14.22
024D252-WT	D 25 PVC Track, White, 9.85'	13.55
024D252-BR	D 25 PVC Track, Brown, 9.85'	13.55
024D252-BL	D 25 PVC Track, Black, 9.85'	13.55
024D252-SV	D 25 PVC Track, Silver, 9.85'	13.55

FURNITURE FLOOR SLIDING
AL 1540 Floor Sliding System for Wood/Alum Doors

- Load capacity: **33 lbs/door**
- FCX track allows for **overlay** door installation - can be installed directly on the cabinet face frame
- CXE track allows for **inset** door installation
- Ball bearing quality rollers for a silent and smooth glide
- Stoppers installed inside the track will hold the door in position
- Min door thickness: 5/8"

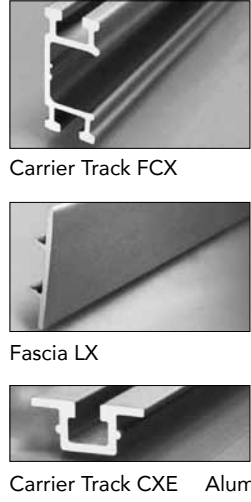

AL 1540
carrier set
for 1 door

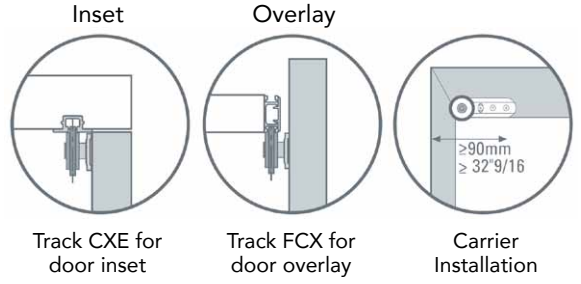
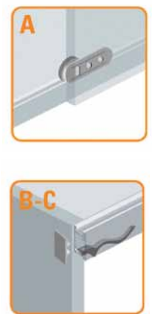

Code	Description	List
012404	AL 1540 Hardware Kit for 1 Door	\$ 33.53
021FCX2	AL 1540 Overlay Track FCX, 9.85'	30.99
041ALX2	AL 1540 Fascia LX, 9.85'	20.32
021CXE1	AL 1540 Flush Mnt Track CXE, 6.5'	10.11
021CXE2	AL 1540 Flush Mnt Track CXE, 9.85'	17.40

DUCASSE

FURNITURE FLOOR SLIDING
CD 30 CX Floor Sliding System for Wood/Alum Doors





- Load capacity: **66 lbs/door**
- Easy installation of flush mounted aluminum track
- Carriers can be flush mounted or surface mounted
- Min door thickness: 5/8"

CD 30 CX
carrier set for 1 door

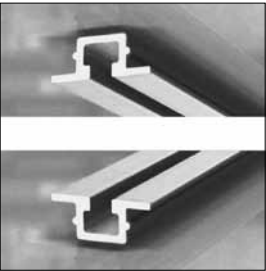
Aluminum

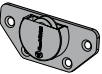

Carrier Track CXE
Flush mount top/bottom

A	2 Carriers CD30CX	
B	2 Top guides CD30CX with clip device	
C	2 Stoppers AL 1535	
D	Screws	

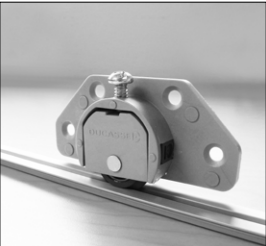

Carrier CD 30 CX

Frontal View

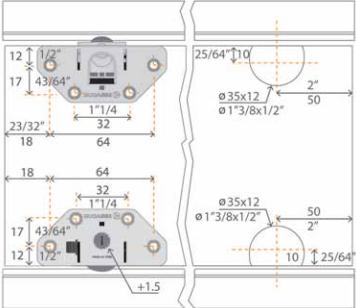

Code	Description	List
10100117092	CD 30 CX Carrier Set, Set for 1 Door	\$ 31.14
021CXE1	Track CXE AL, 6.5'	10.11
021CXE2	Track CXE AL, 9.85'	17.40

BI-FOLD CLOSET SYSTEM
PL2550 - 2 Panel Carrier Set



Folding system for doors installed to overlay the opening. Ideal for closet applications. Includes Euro hinges to fix the door to the lateral. The system can be applied to right or left door.

- Load Capacity: **44 lbs / Door.**
- Door Thickness: 3/4"
- Max. Door Width: 19-11/16"
- Min. Door Frame Height: 1-3/4"
- Ultra-smooth and quiet aluminum track with ball-bearing rollers.

PL2550
carrier set for 2 panels

A	1 Carrier PL2550	
B	1 Euro hinge for carrier	
C	1 Bottom roller guide	
D	5 Euro hinges	
E	4 Central hinges to join the panels	
F	Screws	



Carrier PL2550

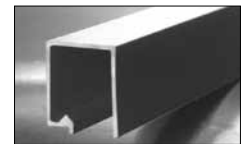

Track PL25

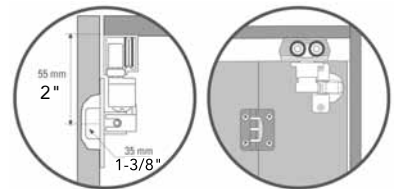

Carrier Installation

Code	Description	List
011303	PL2550, Carrier Set for 2 panels	\$ 52.52
021PL251	PL25 Track 6.5'	42.77
021PL252	PL25 Track 9.85'	53.99

DUCASSE

CLOSET SYSTEMS

 **TOP SLIDING CLOSET**
CA 4585 System for Wood Doors

- Load capacity: **66 lbs/door**
- 8 safety clips assure that the door will not jump out of the track
- Aluminum anodized double tracks for easy installation
- Ball bearing quality rollers for silent, smooth glide
- Min door thickness: 3/4"

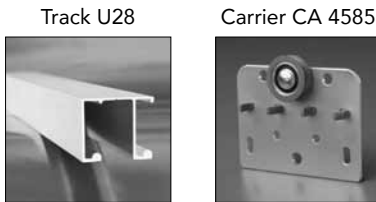

Track U28
For Door Thickness: 3/4" - 7/8"

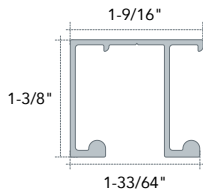

Track U28-35
For Door Thickness: 3/4" - 1-3/8"

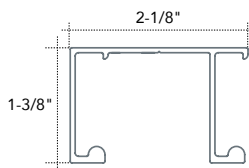

CA 4585
Carrier set for 2 doors

- A** 4 Carriers CA4585 
- B** 2 R Stoppers 2 L Stoppers 
- C** 3 Plastic Guides 
- D** 8 Safety Clips 
- E** 1 Allen Key 
- F** Screws 

Code	Description	List
011205	CA 4585 Carrier set for 2 doors	\$ 40.64
021U281	DoubleTrack U28 AL, 6.5'	45.05
021U28-12	DoubleTrack U28 AL, 12'	82.31

 **FLOOR SLIDING CLOSET**
CD 40 CX System for Wood or Aluminum Doors

- Load capacity: **88 lbs/door**
- Multiple doors can be installed side by side for longer openings
- Options of flush or surface mount carrier tracks
- Double aluminum track allows for an easy and fast installation
- Ball bearing quality rollers for silent, smooth glide
- Min door thickness: 5/8"

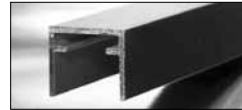

Top Guide GD50 AL

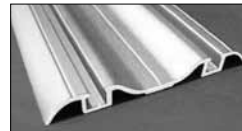

Double Carrier Track CXD





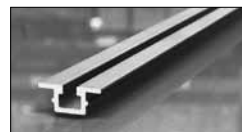

Single Surface Mount Track CX AL



Flush Mount Track CXE AL

CD 40 CX
Carrier set for 2 doors

- A** 4 Carriers CD 40 CX 
- B** 2 Upper R guides 2 Upper L guides 
- C** 4 Stoppers w/ retention device 
- D** 4 Secure Locks 
- E** 1 M5 Key 
- F** Screws 

Carrier Bore: 38-40mm

Code	Description	List
011103	CD 40 CX, Carrier set for 2 doors	\$ 60.96
031D501	Top Guide GD50 AL, 6.5'	36.07
031D502	Top Guide GD50 AL, 9.85'	54.19
031D50-12	Top Guide GD50 AL, 12'	66.05
021CXD1	Dble Surface Mt Track CXD AL, 6.5'	29.47
021CXD2	Dble Surface Mt Track CXD AL, 9.85'	44.03
021CXD-12	Dble Surface Mt Track CXD AL, 12'	57.10
021CX1	Single Surface Mt Track CX AL, 6.5'	20.32
021CX2	Single Surface Mt Track CX AL, 9.85'	30.83
021CX-12	Single Surface Mt Track CX AL, 12'	38.95
021CXE1	Flush Mt Track CXE AL, 6.5'	10.11
021CXE2	Flush Mt Track CXE AL, 9.85'	17.40

CLOSET SYSTEMS

DUCASSE

4

TOP SLIDING CLOSET
DN 50 CLIP System for Wood Doors / Clip-On Carrier

- Load capacity: **110 lbs/door**
- **Clip-on installation** feature provides fast and easy mount and dismount.
- Extremely quiet movement
- Stoppers installed inside the track will retain the door in position
- Min door thickness: 3/4" - 1-3/8", minimum gap 2mm between door and track



Clip-On Carrier

- Height adjustable
- Sealed ball bearings





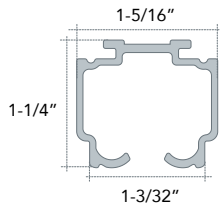

Carrier DN 50 Clip

Track U45 AL



DN 50 CLIP
set for 2 doors

- A** 4 Carriers DN 50 
- B** 4 Mounting plate brackets 
- C** 4 Stoppers w/ retention device 
- D** 2 Floor guides GP-12 
- E** Screws 

Track U45 RT Smooth AL
Double Track

For Door Thickness: 3/4" - 1-3/8"

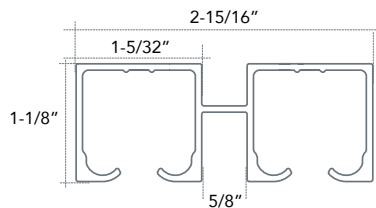

Code	Description	List
10100256051	DN 50 Clip set for 2 doors	\$ 88.06
021U45-08	Track U45 AL, 8'	59.27
021U45-12	Track U45 AL, 12'	88.06
021U45DRT351	Track U45 RT Smooth AL, 6.5'	96.53
021U45DRT352	Track U45 RT Smooth AL, 9.85'	143.95

FLOOR SLIDING CLOSET
D 52 System for Wood or Aluminum Doors

- Load capacity: **110 lbs/door**
- Multiple doors can be installed side by side for longer openings
- Carrier can be installed **inset** for minimum 12mm gap between doors, or **surface mounted** for 15mm gap
- Ball bearing rollers for silent, smooth glide

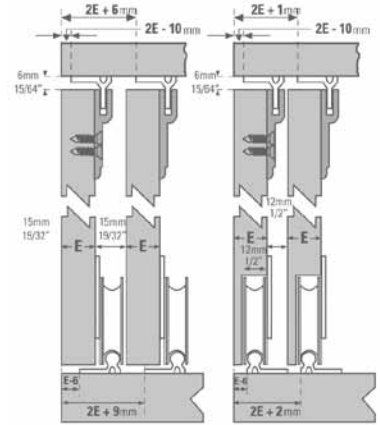

Overlay Carrier





Inset Carrier

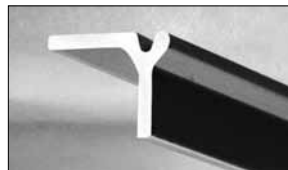

Carrier D 52



Guide Track D 52 AL

- D 52**
set for 2 doors
- A** 4 D52 Carriers 
 - B** 4 D52 Top Guides 
 - C** 1 Bumper 
 - D** Screws 

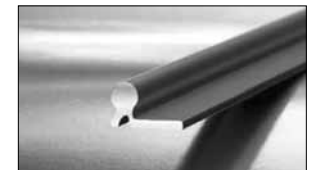

Carrier Track D 52 AL

Code	Description	List
10100106201	D 52 Set for 2 Doors	\$ 44.03
1010058200	Guide D 52 AL, 6.5'	14.56
1010058300	Guide D 52 AL, 9.85'	22.01
1010058-12	Guide D 52 AL, 12'	27.09
1010057200	Track D 52 AL, 6.5'	14.56
1010057300	Track D 52 AL, 9.85'	22.01
1010057-12	Track D52 AL, 12'	27.09

DUCASSE

TOP SLIDING

TOP SLIDING SYSTEM
DN 50 for Wood Doors up to 110 lbs.





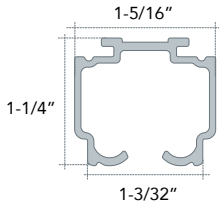
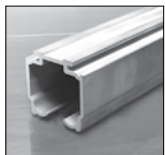

- Top sliding system for wood doors up to 110 lbs.
- Ideal for light pocket door applications and bypass closet doors
- Min door thickness: 3/4", minimum gap 1/2" between door and track
- Optional lateral brackets for barn door installations
- Carrier with enclosed ball bearings seals out dust and grime

Track U45 AL



DN 50
set for 1 door

- 2 Carriers DN 50 
- 2 Stoppers with retention device 
- 1 Floor guide GP-12 
- 2 Mounting plate 
- Screws 

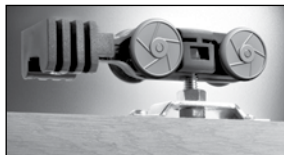

Carrier DN 50

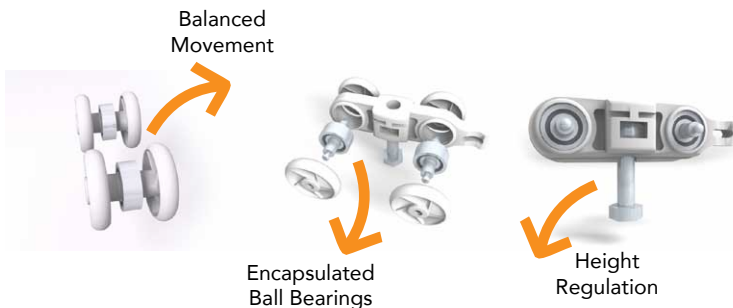

Code	Description	List
10100217271	DN 50, set for 1 door	\$ 88.06
021U45-08	Track U45 AL, 8'	59.27
021U45-12	Track U45 AL, 12'	88.06
021U45DRT351	Track U45 RT Smooth AL, 6.5'	96.53
021U45DRT352	Track U45 RT Smooth AL, 9.85'	143.95

TOP SLIDING SYSTEM
DN 50 SP Kit for Wood Doors up to 110 lbs.



- Top sliding system kit for wood doors up to 110 lbs.
- Complete Kit to install one door overlaying the opening (barn door style) or standard top mount without the fascia, brackets and caps.
- Carrier with enclosed ball bearings seals out dust and grime
- Stoppers inside the track retain the door in position



DN50SP-KIT



Fascia / Track U45 AL

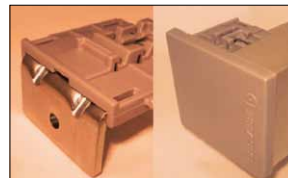

Hidden Connector / Cap

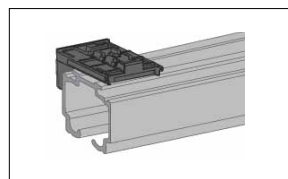

Concealed Brackets

Code	Description	List
DN50SP-KIT	DN 50 SP Kit (includes hdwr & 6.5' U45 Track for 1 door)	\$ 180.12

DN50SP-KIT
contains:

- 2 Carriers DN 50 
- 2 Stoppers with retention device 
- 1 Floor guide GPR 850 
- 2 Mounting plate 
- 1 Track U45 2m (6.5ft) 
- 1 Concealed Bracket Fascia 2m (6.5ft) 
- 6 Concealed Brackets 
- 1 End Cap set for Connector 
- Screws 
- Nuts and Bolts 



BI-FOLD DOOR SYSTEM

BI-FOLD DOOR SYSTEM
DN 80 PL 2 Folding System for 2 heavy doors



For 2 Doors

- Load Cap: **88 lbs/door**, ANSI-BHMA, Grade 1
- Ultra-smooth and quiet, aluminum track and ball-bearing rollers
- For doors up to 29-1/2"
- Min door thickness: 13/16"



Carrier Installation

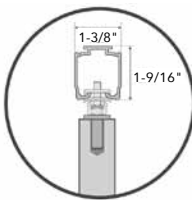

Track Installation

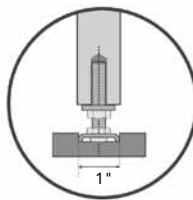

Lower Pivot Installation



Carrier DN 80 PL



Track U21

DN 80 PL 2
set for 2 panels

A	1 Carrier DN 80	
B	1 Upper fixed base/pivot	
C	1 Lower fixed base/pivot	
D	3 Central hinges	
E	Regulation key	
F	1 Aligner	
G	1 Mounting plates	
H	Screws	

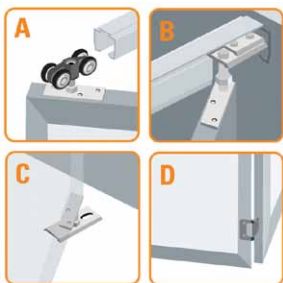

Code	Description	List
013301	DN 80 PL 2, 2 panels carrier	\$ 45.57
021U211	DN 80 CF Track 6.5'	78.47
021U21-8	DN 80 CF Track 8'	86.53
021U21-12	DN 80 CF Track 12'	132.14
021U213	DN 80 CF Track 19.7'	260.00

DUCASSE

BI-FOLD DOOR SYSTEM
DN 80 PL 4 Folding System for 4 heavy doors



For 4 Doors

- Load Cap: **88 lbs/door** ANSI-BHMA, Grade 1
- Ultra-smooth and quiet, aluminum track and ball-bearing rollers
- For doors up to 29-1/2"
- Min door thckns: 13/16"

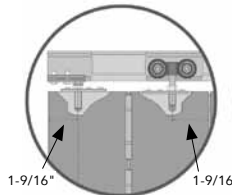

Carrier Installation

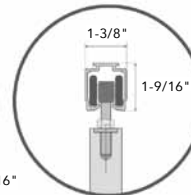

Track Installation

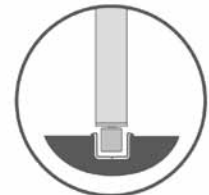

Guide Installation



Carrier DN 80 PL



Track U21

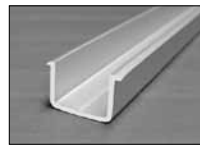

Floor Guide Track

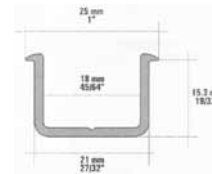

DN 80 PL 4
set for 4 panels

A	2 Carrier DN 80	
B	1 Upper fixed base/pivot	
C	1 Lower fixed base/pivot	
D	9 Central hinges	
E	2 Guides GC-16	
F	Regulation key	
G	1 Aligner	
H	2 Mounting plates	
I	Screws	

Code	Description	List
013302	DN 80 PL 4, 4 panels carrier	\$ 86.81
021U211	DN 80 CF Track 6.5'	78.47
021U21-8	DN 80 CF Track 8'	86.53
021U21-12	DN 80 CF Track 12'	132.14
021U213	DN 80 CF Track 19.7'	260.00
10100608020	Guide Track PL, AL, 6.5'	\$ 24.03
101006080-08	Guide Track PL, AL, 8'	28.45
10100608030	Guide Track PL, AL, 9.85'	39.29
101006080-12	Guide Track PL, AL, 12'	48.53

DUCASSE

TOP FOLDING DOOR SYSTEM

 **Concealed Top Folding System for Wood Doors**
Tauro Wood PLMD - 50

Configuration Examples



2 Panel Kit

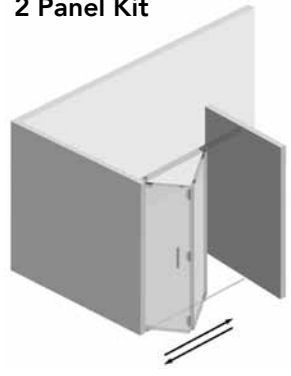

TAURO WOOD 2 Panel KIT	
PART NUMBER: 10300001451	
(A)	1 Carrier set Tauro PLMD 50
(B)	1 upper pivot set PLMD 50
(C)	1 Lower pivot set PLMD 50
(D)	3 Concealed hinges
(E)	1 Bottom roller guide
(F)	4 PLMD End caps
(G)	4 Mounting plates
(H)	1 Spring Aligner
(I)	1 Bracket Aligner
(J)	1 Segmenta Key
(K)	1 Segmenta 01 Key
(L)	Screws

2 Panel Kit and 2 Panel Kit

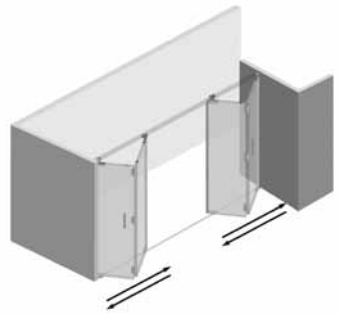

Kit + 2 Panels TAURO WOOD	
PART NUMBER: 10300001453	
(A)	1 Set Tauro PLMD 50
(B)	1 Bottom roller guide
(C)	2 PLMD End Caps
(D)	2 Mounting plates
(E)	6 Concealed hinges
(F)	1 Spring Aligner PLMD
(G)	1 Bracket Aligner PLMD
(H)	1 Segmenta key
(I)	Screws

2 Panel Kit and +2 Panels

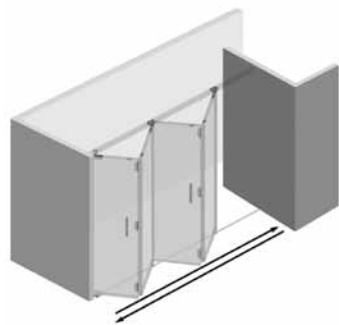

2 Panel Kit and Pivot Door Kit

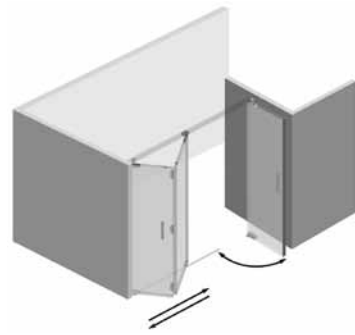

Pivot Door Kit TAURO WOOD	
PART NUMBER: 10300001455	
(A)	1 Upper pivot set PLMD 50
(B)	1 Lower Pivot set PLMD 50
(C)	2 PLMD End Caps
(D)	2 Mounting plates
(E)	1 Spring Aligner PLMD
(F)	1 Segmenta key
(G)	Screws

- Up to **110 lbs** per panel and max of 660 lbs in the stacking area
- Modular system: up to six panels per side
- For partitions, meeting rooms, family rooms
- Concealed "Soss" type hinges for a clean look when closed
- Floor Guide track for smooth folding
- Concealed bottom roller guide with height adjustment
- Spring-aligner keeps doors flat in a closed position
- Top bracket-aligner will prevent over extension of doors
- Maximum flexibility to make your own set up
- Door Thickness: 1-19/64" min
- Max Door Width: 29-1/2"
- Gap between Door and Track: 5/16"
- Gap between Door and Floor: 7/64"



1010060569-12
U150 Track
Smooth 12'



101006080-12
Guide Track 12'

Code	Description	List
10300001451	Tauro Wood 2 Panel Kit	\$ 1640.00
10300001453	Tauro Wood Kit +2 Panels	1095.00
10300001455	Tauro Wood Pivot Door Kit	869.46
1010060569-12	U150 Smooth, 12'	374.07
101006080-12	Guide Track PL, 12'	48.53



TOP SLIDE DOOR SYSTEM

DUCASSE

4



TOP SLIDING DOOR SYSTEM

DN 80 CF for Wood or Aluminum Doors, 176 lb/ Door

- 176 lb. load capacity, ANSI-BHMA Grade 1
- Ultra-smooth and quiet, aluminum track and ball-bearing rollers
- Minimum Door Thickness: 13/16"
- Door-Track Gap: 17 - 23mm, Door-Floor Gap: 10mm
- Instop holds door - No bounce
- Standard inlay installation
- Optional Easy Soft avoids doors from bumping and ensures the doors are always closed (see next page)
- Optional U21 Fascia and End Caps easily connect to track with a snap providing a clean, solid and elegant look (see page 440)



Carrier DN 80 CF

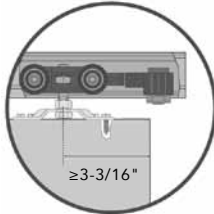

Carrier Installation

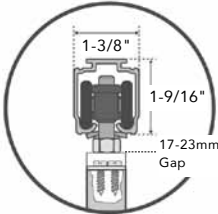

Track Installation

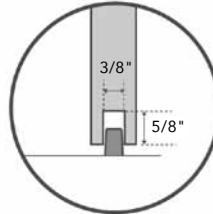

Guide Installation

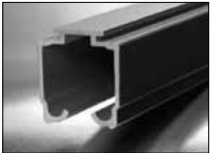

Track U21

Code	Description	List
013203	DN 80 CF, Set for 1 Door	\$ 62.61
021U211	DN 80 CF Track 6.5'	78.47
021U21-8	DN 80 CF Track 8'	86.53
021U21-12	DN 80 CF Track 12'	132.14
021U213	DN 80 CF Track 19.7'	260.00

DN 80 CF set for 1 door

A	2 Carriers DN 80	
B	2 Stoppers with retention device	
C	1 Floor guide GP-12	
D	2 Mounting plate	
E	Screws	



GLASS SLIDING SYSTEM

DN 80 VD Compression, 176 lb/ door

- For Glass Doors 3/8" - 1/2" thick
- Load Cap: 176 lbs, ANSI-BHMA, Grade 1
- Compression clamps avoid the need to bore glass
- For complete kit you will need:
 - (1) DN 80 VD set for one door
 - (1) Compression Clamp Kit
 - (1) Spacer Kit (for either 3/8" or 1/2" panels)
- Use above U21 Tracks

Code	Description	List
013216	DN 80 VD, set for one panel	\$ 63.69
10300001501	Compression Clamp Kit	230.51
013218	Spacer Kit 3/8" (8-10mm)	24.26
013219	Spacer Kit 1/2" (12-13mm)	24.26

DN 80 VD set for 1 door

A	2 Carriers DN 80 VD	
B	2 Stoppers with retention device	
C	2 Bushings	

Compression Clamp Kit & DN 80 VD (shown w/ fascia)

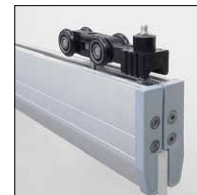

Spacer Kit

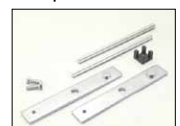

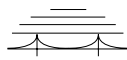

DUCASSE

SOFT CLOSE TOP SLIDE



Easy Soft DN 80

Concealed Soft-Close for Doors between 110 - 176 lbs.



Soft Close for Sliding Doors

The Easy Soft DN 80 is a soft close system made of 2 parts: 1 Easy Soft DN 80 Kit and 1 Annex Kit. Use 1 Easy Soft DN 80 for soft close in one direction only. Use 2 of them for soft close in both directions.

Use DN 80 CF or DN 80 FT Annex Kits depending on mounting type and door thickness. Minimum door width with 1 Easy Soft: 21-3/4", 2 Easy Soft: 31-1/4". Use with U 21 Tracks.

Finished opening height - door height: 2-7/8" (73mm)
 Finished floor to door bottom: 7/16" - 5/8" (10-15mm)
 Top of door to bottom of track: 13/16" - 1" (20-25mm)

4



Std. Gap

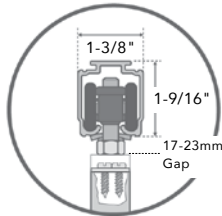

Std. 3/4" gap between track and door



Tight Gap

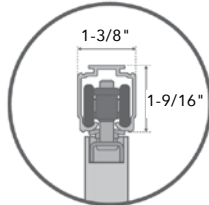

1/8" gap between track and door

Easy Soft DN80 CF Annex Kit : Door Thickness ≥ 13/16" (20mm)

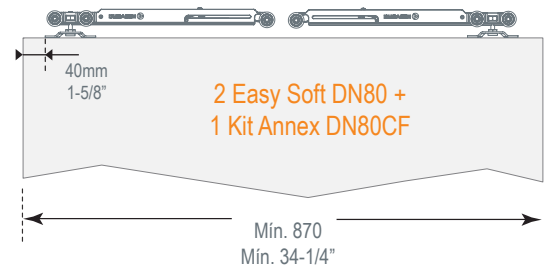
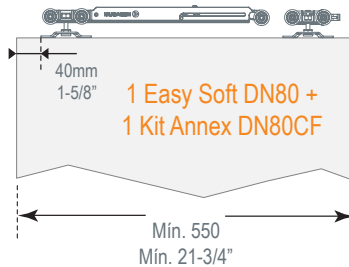

Easy Soft DN80 FT Annex Kit : Door Thickness ≥ 1" (25mm)

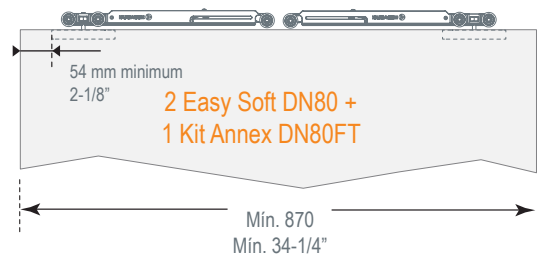
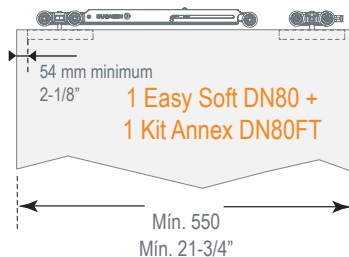

Easy Soft DN 80 / For 1 door

- 1 Soft Close DN 80
- 1 ES Activator
- 1 DN 80 Carrier
- 1 Stopper with retension device
- Screws

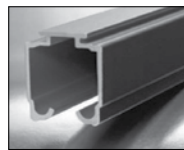

Track U21

Annex Kit DN 80 CF

Pack: 10/Ctn

Code 10107026486 List/ea \$ 13.55

- 2 DN 80 CF mounting plates
- 2 Carrier bolts
- 4 Hex Nuts
- 1 Guide GPR 850
- Screws

Annex Kit DN 80 FT

Pack: 10/Ctn

Code 10107026487 List/ea \$ 27.02

- 2 DN 80 FT mounting plates
- 2 Carrier bolts
- 4 Hex Nuts
- 1 Segmenta key
- 1 Guide GPR 850
- Screws

Code	Description	List
10107026485	Easy Soft DN 80	\$ 132.09
021U211	DN 80 CF Track 6.5'	78.47
021U21-8	DN 80 CF Track 8'	86.53
021U21-12	DN 80 CF Track 12'	132.14
021U213	DN 80 CF Track 19.7'	260.00

TOP SLIDE DOOR SYSTEM

DUCASSE

SLIDING DOOR SYSTEM
DN Concealed LT, 176 lbs/ door

1/8" gap
Between Door
and Track

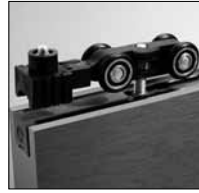

Carrier DN 80
Concealed LT

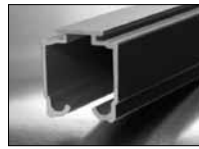

Track U21

- 1/8" gap between door and track
- **176 lb.** load capacity
- Minimum Door Thickness: 1-1/8"
- Ultra-smooth and quiet, aluminum track and ball-bearing rollers
- Instop holds door - No bounce.
(Not for pocket door installation)

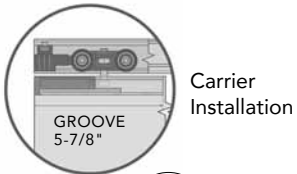

Carrier
Installation

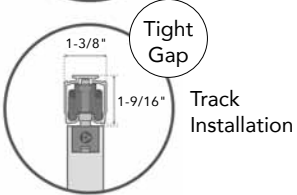

Tight
Gap
Track
Installation

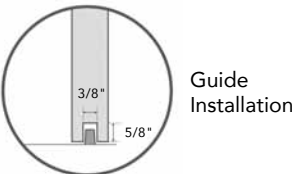

Guide
Installation

DN 80 Concealed LT
set for 1 door

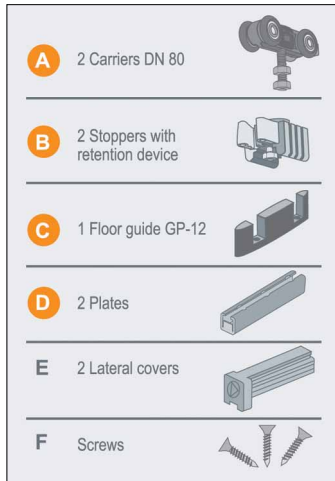

Code	Description	List
013213	DN 80 Concealed LT, set for 1 door	\$ 95.08
021U211	DN 80 CF Track 6.5'	78.47
021U21-8	DN 80 CF Track 8'	86.53
021U21-12	DN 80 CF Track 12'	132.14
021U213	DN 80 CF Track 19.7'	260.00

TOP SLIDING DOOR SYSTEM
DN 80 Concealed FT, 176 lb/ door

1/8" gap
Between Door
and Track



- 1/8" gap between door and track
- **176 lb.** load capacity
- Minimum Door Thickness: 1"
- Mounting plates allow for "lift-up" installation, **ideal for pocket doors**

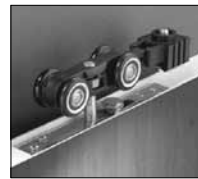

Carrier DN 80
Concealed FT

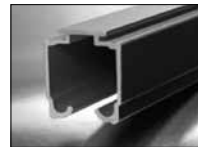

Track U21

DN 80 Concealed FT
set for 1 door

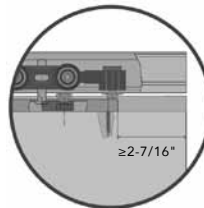

Fixed Panel
Track Installation

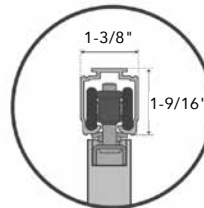

1/8" gap between
track and door

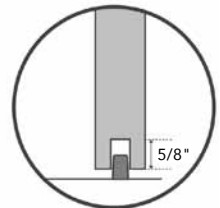

Guide
Installation

Code	Description	List
013206	DN 80 Concealed FT, set for 1 door	\$ 106.50
021U211	DN 80 CF Track 6.5'	78.47
021U21-8	DN 80 CF Track 8'	86.53
021U21-12	DN 80 CF Track 12'	132.14
021U213	DN 80 CF Track 19.7'	260.00

DUCASSE











TOP SLIDE DOOR SYSTEM

 **SYNCHRO TWIN TELESCOPING WOOD**
Load Capacity: 176 lbs. per door



- For 2 bypassing **synchronized** doors that will open in the same direction with only one movement
- Allows for door widths up to 60"
- Ball bearing high quality rollers for a silent smooth glide
- No bounce: Instop holds door
- Stoppers with retention device concealed in the track
- Door thickness: 13/16" to 1-3/8"
- Door-Track Gap: 1"
- Door-Floor Gap: 25/64"

Twin Telescopic Wood Kit for 2 Doors
#10300001399 includes:

- A** 4 Carriers DN 80 CF 
- B** 2 Twin mounting plates with polley 
- C** Wall cable plate 
- D** 2 Twin mounting plates 
- E** 2 Stoppers with retention device 
- F** 1 Telescopic guide 
- G** 1 GP 12 guide 
- H** 4.2 mt - 13' 7" of cable 
- I** 4 mounting plates for AGATAAL profile 
- J** Bolts 

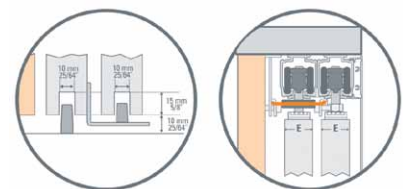
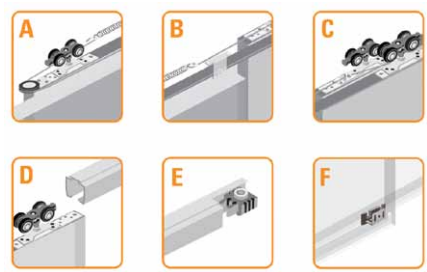
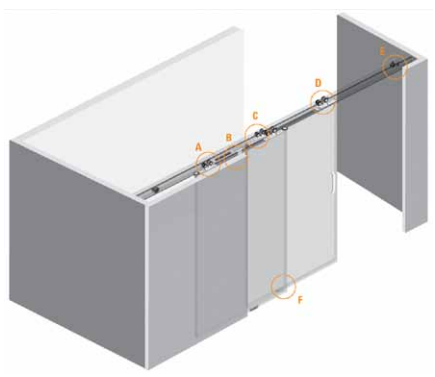

- 176 lbs. ANSI - BHMA Grade 1
- Ultra-smooth, quiet
- Use the DN 80 Track

Code	Description	List
10300001399	Twin Telescopic Kit for Wood	\$ 695.65
021U211	DN 80 CF Track 6.5'	78.47
021U21-8	DN 80 CF Track 8'	86.53
021U21-12	DN 80 CF Track 12'	132.14
021U213	DN 80 CF Track 19.7'	260.00









 **SYNCHRO TWIN OPPOSITE WOOD**
Load Capacity: 176 lbs. per door



4

- System for **synchronized** doors that will open in opposite directions by only opening one door
- Allows for door widths up to 60"
- Door can be installed to overlay the opening or 'barn door' style using wide lateral brackets
- Ball bearing high quality rollers for a silent smooth glide
- Stoppers with retention device concealed in the track
- No bounce: Instop holds door
- Door thickness: 13/16" to 1-1/2"
- Door-Track Gap: 1"
- Door-Floor Gap: 25/64"

Twin Opposite Wood Kit for 2 Doors
#10300001404 includes:

- A** 4 Carriers DN 80 CF 
- B** 4 Twin mounting plates with cable fastener 
- C** 2 Stoppers with retention device 
- D** 2 GP 12 guide 
- E** 2 Stoppers with polley 
- F** 4 mounting plates 
- G** 4.2 mt - 13' 7" of cable 
- H** Screws 

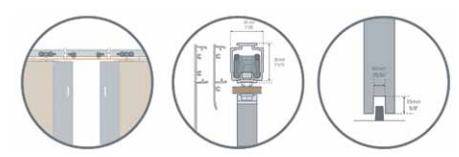
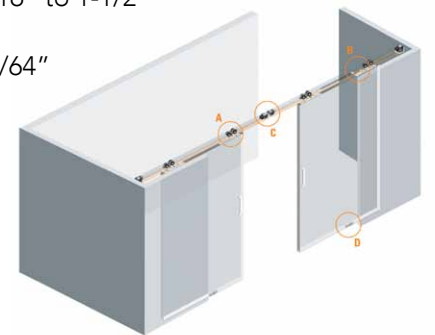

- Use the DN 80 Track

Code	Description	List
10300001404	Twin Opposite Kit for Wood	\$ 695.65
021U211	DN 80 CF Track 6.5'	78.47
021U21-8	DN 80 CF Track 8'	86.53
021U21-12	DN 80 CF Track 12'	132.14
021U213	DN 80 CF Track 19.7'	260.00

TOP SLIDE DOOR SYSTEM

DUCASSE







TOP SLIDING PARTITION
DN 150 Concealed FT for Pocket Doors

- Load capacity: **330 lbs/door**
- FT Carrier allows **smaller gap** between door/track
- Door-Track Gap: 16mm
Door-Floor Gap: 4mm
- Unique mounting plates allow for a 'lift up' installation; ideal for pocket door solutions
- Optional wide barn door brkt and fascia for U150 track
- Ball bearing high quality rollers for silent, smooth glide
- Min door thickness: 1"

4



DN 150 FT
carrier set
for 1 door

A	2 Carriers DN 150 FT	
B	2 Stoppers with retention device	
C	1 Floor Guide	
D	2 Mounting Plates	
E	1 Segmenta Key	
F	Screws	



Carrier DN 150 FT
330 lbs/door

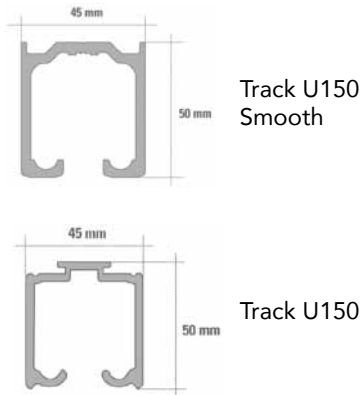

Code	Description	List
10100219525	Carrier Set for 1 door	\$ 220.15
1010060569-08	Track U150 Smooth AL, 8'	208.30
10100605693	Track U150 Smooth AL, 9.85'	254.01
1010060569-12	Track U150 Smooth AL, 12'	374.07
10100605696	Track U150 Smooth AL, 19.7'	508.03
021U1501	Track U150 AL, 6.5'	151.65
021U1502	Track U150 AL, 9.85'	227.46
021U1504	Track U150 AL, 12'	324.82
021U1503	Track U150 AL, 19.7'	526.49

EASY SOFT DN 150

Provides **Soft Close** for 1 Door (Use with DN 150 systems)

- Load capacity: **187-330 lbs/door**
- System made of 2 components: The Easy Soft DN 150 and Kit Annex Easy Soft DN 150. Combinations of both provide 1 door with 1 or 2 soft closes (see below)
- System hidden in track making it a concealed soft close
- Avoids doors from bumping and insures the doors are always closed



Easy Soft DN 150

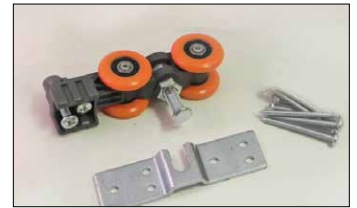

Kit Annex Easy Soft DN 150



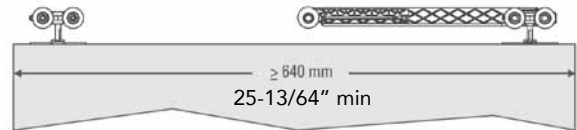

Installation with Soft Close on 1 side:
Easy Soft DN 150 + Kit Annex DN 150

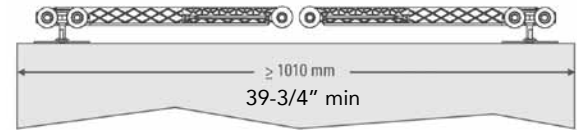



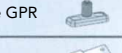
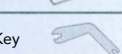

Installation with Soft Close on 2 sides:
2 Easy Soft DN 150



Easy Soft DN 150
Set for 1 door

A	1 Soft Close DN 150	
B	1 Soft Close Activator	
C	1 Floor Guide GPR	
D	1 Mounting Plate	
E	1 Segmenta Key	
F	Screws	

Kit Annex DN 150
Set for 1 door

A	1 Carrier DN 150 CF	
B	2 Stoppers with retention device	
C	1 Mounting Plate	
D	Screws	

* For use with Tracks U150 AL and U150 Smooth AL

Code	Description	List
10107026510	Easy Soft DN 150, for 1 Door	\$ 304.82
10107026520	Kit Annex DN 150, for 1 Door	67.74
10107026525	Kit Annex DN 150 FT, for 1 Door	67.74

DUCASSE

ACCESSORIES

HEAVY DUTY TOP SLIDING DOOR SYSTEM
DN 150 CF, Load Cap: 330 lbs/ door



- **330 lb.** load cap, ANSI-BHMA Grade 1
- Ultra-smooth and quiet, aluminum track and ball-bearing rollers
- Minimum Door Thickness: 1-3/16"
- Instop holds door - No bounce
- Lateral Bracket 023BRAU21W will allow installation of the track to the wall ("Barn Door" effect)

Install Easy Soft DN 150 for **Soft Close** Feature - see previous page for details.

DN 150 CF
Set for 1 door

A	2 Carriers DN 150 CF	
B	2 Stoppers with retention device	
C	1 Floor Guide	
D	2 Mounting Plates	
E	1 Segmenta Key	
F	Screws	



Carrier DN 150 CF

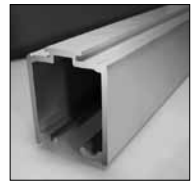

Track U150 AL

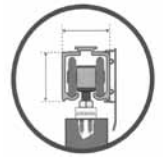

Track Installation

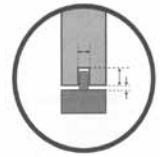

Guide Installation

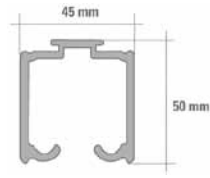

Code	Description	List
013220	DN 150 CF Hardware Kit	\$ 132.00
021U1501	Track U150 AL, 6.5'	151.65
021U1502	Track U150 AL, 9.85'	227.46
021U1504	Track U150 AL, 12'	324.82
021U1503	Track U150 AL, 19.7'	526.49
023BRAU21W	"Barn Door" Wide Bracket	28.91



"BARN DOOR" BRACKETS

Allows Door Track to be installed on wall.

- Can be used with:**
- DN 80 CF
 - DN 80 Concealed FT
 - DN 80 Concealed LT
 - DN 150 CF (023BRAU21W only)

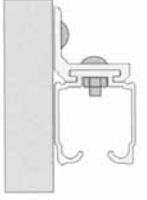
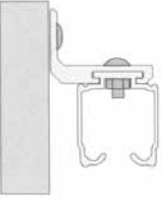

4

Standard	Wide	Lateral Installation	
			
31.2mm 1-1/4"	44.7mm 1-3/4"	Std.	Wide
023BRAU21	023BRAU21W		

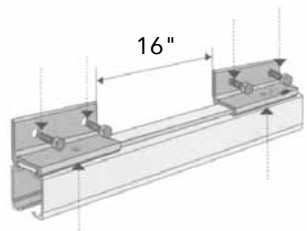

Brackets should be installed 16" or less apart from each other.

Small Brackets: 3-7/8" Length, Packed: 2 per bag.

Code	Description	List/bg
023BRAU21	Standard Bracket, 1-1/4"	\$ 18.24
023BRAU21W	Wide Bracket, 1-3/4"	28.91

Long Brackets: 2 Lengths avail, Packed: 10 ea/Ctn.

021BRAU21W-2	Wide Bracket, 1-3/4" x 2m (6.5 ft)	\$ 77.90
021BRAU21W-3	Wide Bracket, 1-3/4" x 3m (9.85 ft)	116.85



ACCESSORIES

DUCASSE

FLOOR GUIDE GP12

Use with:
DN 50 / LT
DN 80 CF / LT / FT
Dn 150 CF / FT

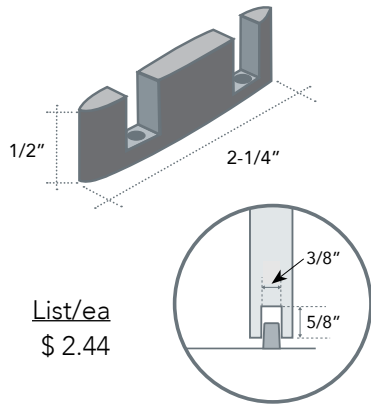

Code	Ctn	List/ea
10101108003	50	\$ 2.44

WALL BRACKET TELESCOPIC LOWER GUIDE

Use with DN 50/LT, DN 80 CF/LT/FT, DN 150 CF/FT

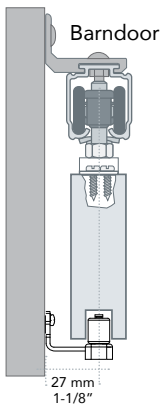

To be installed on the wall when installing a floor guide is difficult. Has 3 positions to adjust for different door thicknesses.

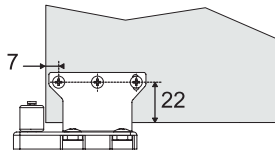
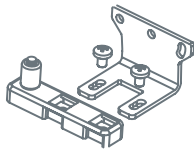

Code	Ctn	List/ea
WBTLG	100	\$ 21.89

FLOOR GUIDE TRACK GPR AL

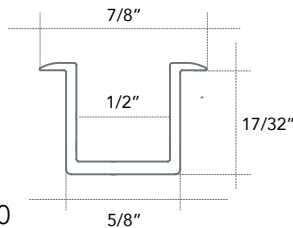

- Use with Floor Guide GPR 1150
- 9.85' (3m)

Code	Length	List/ea
031GPR11502	9.85'	\$ 28.79

FLOOR GUIDE GPR 1150

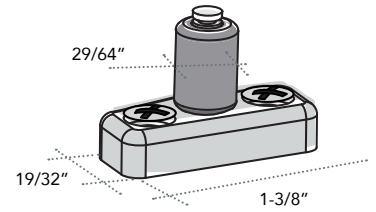
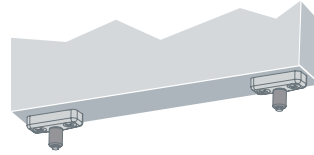

- To be attached at the bottom of the door
- For wood or aluminum doors with a minimum thickness of 3/4"
- Use with aluminum guide track GPR AL

Code	List/ea
10100900520	\$ 10.67

FLOOR GUIDE - 17.5 MD

Use with Floor Guide Track PL

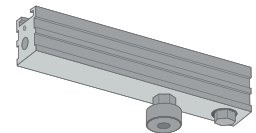

Code	Ctn	List/ea
10300001460	8	\$ 118.54

GUIDE TRACK PL

Use with: DN 80 PL4, Tauro PLMD Wood, Tauro PLVD Glass

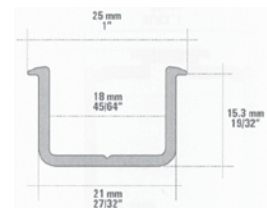
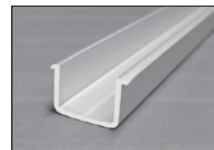

Code	Description	List
10100608020	Guide Track PL, AL, 6.5'	\$ 24.03
101006080-08	Guide Track PL, AL, 8'	28.45
10100608030	Guide Track PL, AL, 9.85'	39.29
101006080-12	Guide Track PL, AL, 12'	48.53

DUCASSE

ACCESSORIES

U21 END CAP
For U21 Track

Accessory for U21 Track to install when the ends of the track are visible.

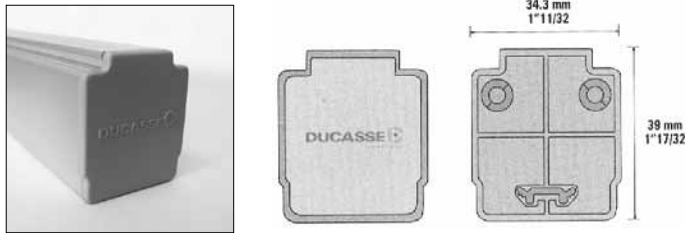

Code	Description	List/pr
10100910020	U21 End Cap	\$ 8.59

U21 END CAP W/ FASCIA
For U21 Track w/ Fascia

Accessory for U21 Track and U21 Double Track with Fascia to install when the ends of the track are visible.

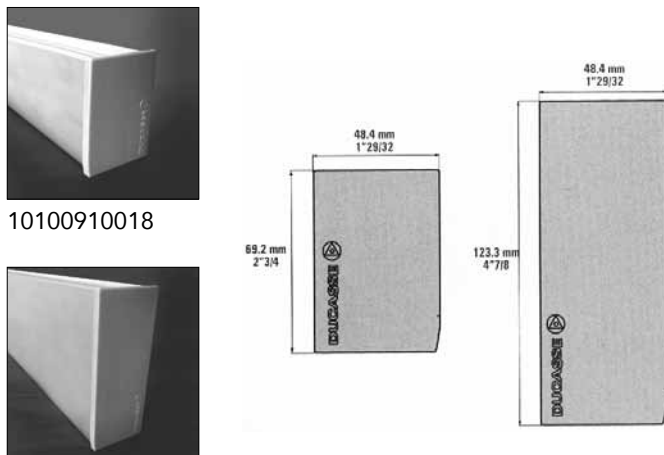

Code	Description	List/pr
10100910018	U21 End Cap w/ 2-3/4" Fascia	\$ 13.20
10100910019	U21 End Cap w/ 4-7/8" Fascia	24.36

U21 FASCIA

For U21 Track or U21 Double Track

Anodized aluminum fascia for U21 track. It gives a clean and elegant look to your project. Available in 2 different heights and various lengths. Not for use on "Smooth" style track.

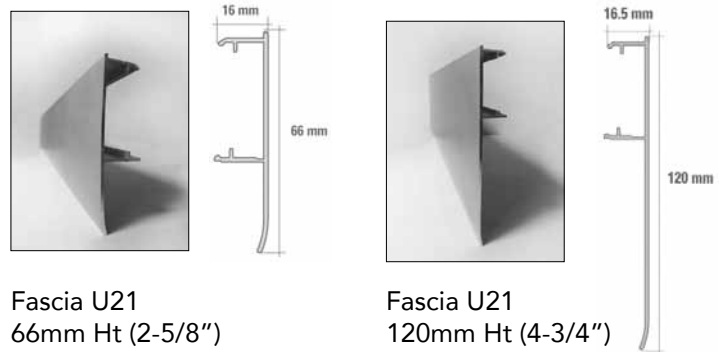

Fascia U21 66mm Ht (2-5/8") Fascia U21 120mm Ht (4-3/4")

Code	Description	List
041U21661	Fascia U21, 2-5/8" Ht, 6.5'	\$ 54.55
041U2166-08	Fascia U21, 2-5/8" Ht, 8'	64.35
041U21662	Fascia U21, 2-5/8" Ht, 9.85'	81.07
041U2166-12	Fascia U21, 2-5/8" Ht, 12'	80.29
041U211201	Fascia U21, 4-3/4" Ht, 6.5'	\$ 95.84
041U211202	Fascia U21, 4-3/4" Ht, 9.85'	143.66

U150 FASCIA
For U150 Track

Anodized aluminum fascia for a clean look. Not for use on "Smooth" style track.

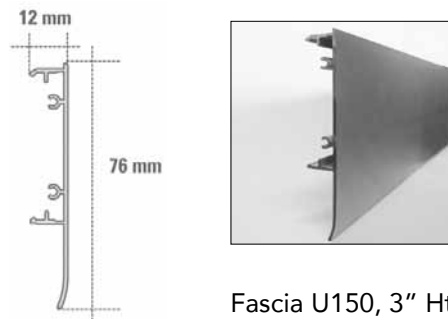

Fascia U150, 3" Ht

Code	Description	List
041U15076-08	Fascia U150, 3" Ht, 8'	\$ 77.90
041U150762	Fascia U150, 3" Ht, 9.85'	90.90
041U15076-12	Fascia U150, 3" Ht, 12'	115.81

TRACK

DUCASSE

TRACK U21 RT (SMOOTH):
A finished look for seamless exposed track

Use with: DN 80 PL2, DN 80 PL4, DN 80 LT, DN 80 FT, DN 80 VD, Twin Telescopic Wood (and Glass), Twin Opposite Wood (and Glass)

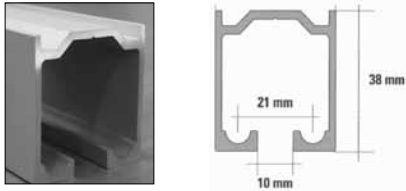

Code	Description	List
10100626082	Track U21 RT AL Smooth, 6.5'	\$ 77.90
10100626083	Track U21 RT AL Smooth, 9.85'	116.85
1010062608-12	Track U21 RT AL Smooth, 12'	150.72
10100626086	Track U21 RT AL Smooth, 19.7'	287.00

TRACK U21 DOUBLE: Faster installation of double track

Use with: Twin Telescopic Wood (and Glass), DN 80 CF, DN 80 LT, DN 80 FT, DN 80 VD

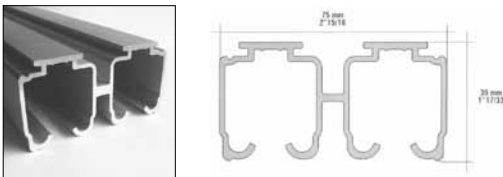

Code	Description	List
10100603020	Track U21 Double, 6.5'	\$ 162.57
101006030-08	Track U21 Double, 8'	203.21
10100603030	Track U21 Double, 9.85'	243.85
101006030-12	Track U21 Double, 12'	301.43

TRACK U21 CA (WITH WINGS):

To Mount flush with finished ceiling

Use with: DN 80 LT, DN 80 FT, DN 80 VD

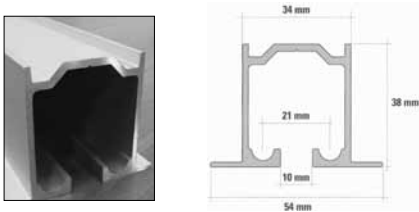

Code	Description	List
10100626093	Track U21 CA, w/ Wings, 9.85'	\$ 130.39
1010062609-12	Track U21 CA, w/ Wings, 12'	167.64

TRACK U150 AL: Heavy duty track

Use with: DN 150 CF, DN 150 VD

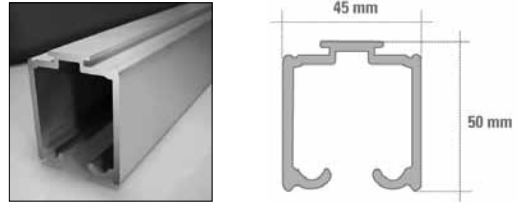

Code	Description	List
021U1501	Track U150 AL, 6.5'	\$ 151.65
021U1502	Track U150 AL, 9.85'	227.46
021U1504	Track U150 AL, 12'	324.82
021U1503	Track U150 AL, 19.7'	526.49

TRACK U150 (SMOOTH) Heavy duty track, finished look

Use with: Tauro PLMD Wood, Tauro PLVD Glass, DN 150 CF, DN 150 VD

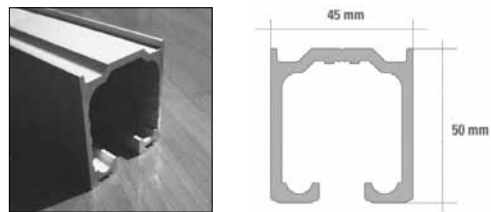

Code	Description	List
1010060569-08	Track U150 Smooth AL, 8'	\$ 208.30
10100605693	Track U150 Smooth AL, 9.85'	254.01
1010060569-12	Track U150 Smooth AL, 12'	374.07
10100605696	Track U150 Smooth AL, 19.7'	508.03

TRACK U45 RT SMOOTH DOUBLE AL

Use with DN 50 CLIP System

- For Door Thickness 3/4" - 1-3/8"
- Available in 6.5' (2m) and 9.85' (3m)

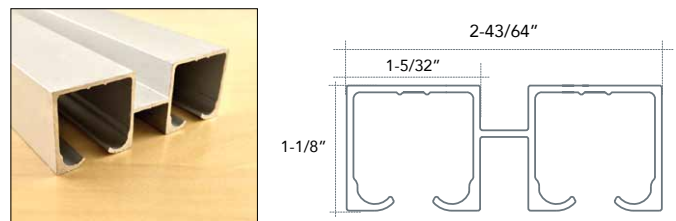

Code	Description	List/ea
021U45DRT351	Track U45DRT, 6.5'	\$ 96.53
021U45DRT352	Track U45DRT, 9.85'	143.95



Flat Track by Leatherneck Hardware, Inc.
Designer Sliding Door Hardware

Flat Track Hardware styling dates back to the turn of the century when it was used in warehouses and industrial settings. Today this look is perfect for unique interior/exterior applications. The hardware can be customized for specific applications, is space saving, and will enhance any opening. Available in clean, simple styling or can be designed to be ornate depending on the application. Comes in several finishes and styles.

Capacities are 400 lb and 800 lb units.

Flat Track Hardware is available for order in complete kits for single slide openings. The hardware can also be ordered as individual components.



4

- Drop Ship, FOB Danville, Illinois
- Check out www.doorhdwe.com for more information

142 Hanger Styles / 400 lbs.

11" Length



401 Arrowhead



402 Straight



403 Horseshoe



403 DBHH Double Bar Horseshoe



407 Top Mount



409 I-Shape



410 Teardrop



411 Wide Teardrop



413 Swivel

144 Hanger Styles / 800 lbs.

21" Length



404 Teardrop



405 Straight



406 Industrial Wide Teardrop

Wheels

3" Standard Steel Wheels (avail in all finishes)



Other Wheel Styles Available:

2-1/2" Low Profile Steel Wheels, 3" Quiet Wheels (made from durable polymer material) and New Aluminum Spoke Wheels 402S: a highly stylized 6" Wheel. Interchangeable with #142 Hanger Styles.

Finishes



00 Flat Black



25 Unfinished



27 Clear Coated



30 Machine Polished



40 Mill Finish Stainless Steel



50 Brushed Stainless Steel



60 Weathered Rust



80 Painted Bronze



90 Brushed Nickel

Please note the following:

To compose a complete order for one 1-3/4" door, the following items are needed:

- 2 Hangers
- 1 Flat Track
- 2 Door Stops
- 2 Anti-Jump Blocks
- 1 Fin Guide
- Mounting Screws (amount dependent on track size)





Leatherneck Hardware Kits

The following Leatherneck Kits Include:

- 2 ea. #402 Straight Hangers
- 1 ea. #142 Flat Track
- 2 ea. Door Stops
- 2 ea. Anti-Jump Blocks
- 1 ea. Fin Guide
- Mounting Screws
(amount dependent on track size)



4

Kit - Black Finish			Kit - Brushed Nickel			Kit - Painted Bronze		
Kit	Track	List	Kit	Track	List	Kit	Track	List
1024-0001	5' Track	\$ 373	1024-9001	5' Track	\$ 564	1024-8001	5' Track	\$ 560
1024-0002	6' Track	376	1024-9002	6' Track	569	1024-8002	6' Track	565
1024-0003	7' Track	390	1024-9003	7' Track	590	1024-8003	7' Track	584
1024-0004	8' Track	397	1024-9004	8' Track	600	1024-8004	8' Track	595



SLIDING TRACK SYSTEM

Stainless Steel Sliding Track System

Special Order



4

Configurations:

- Bi-parting (splice rod needed)
- Single

Installations:

- Side Wall Mount (only)

Finish:

- Brushed Stainless Steel

Features:

- Smooth & quiet operation with nylon coated stainless steel wheel
- Made of 304 stainless steel
- Hangers equipped with anti-rise pin so door cannot lift off track
- 176 lb (W60) / 198 lb (W100) panel capacity
- Tested to meet strict performance standards of ANSI/BHMA 156.14.

Kits Include:

- 1 ea 304 Stainless Steel Track w/ End Caps and Wall Brackets
- 2 ea Stainless Steel Hangers
- 1 ea Door Bottom Guide for 3/8" undercut
- 2 ea Track Stops
- Mounting / Installation Hardware

W60 Kit - For 1-3/4" Wood Doors

	<p>W60</p> <p>Door Weight: Up to 176 lbs.</p> <p>Hanger Height: 4-3/8"</p>
---	---

W100 Kit - For 1-3/4" Wood Doors

	<p>W100</p> <p>Door Weight: Up to 198 lbs.</p> <p>Hanger Height: 3-13/16"</p>
--	--

Part Number	Material	Track Length	Door Width	List
W60/6	304 St Steel	78-3/4"	36"	\$ 494
W60/8	304 St Steel	98-7/16"	48"	552
Splicerod	Splice rod for Bi-Parting			180

Part Number	Material	Track Length	Door Width	List
W100/6	304 St Steel	78-3/4"	36"	\$ 614
W100/8	304 St Steel	98-7/16"	48"	672
Splicerod	Splice rod for Bi-Parting			180

Specs next page



SLIDING TRACK SYSTEM

W60 Series - For Wood Doors

For Sliding Panels up to 176 lbs.

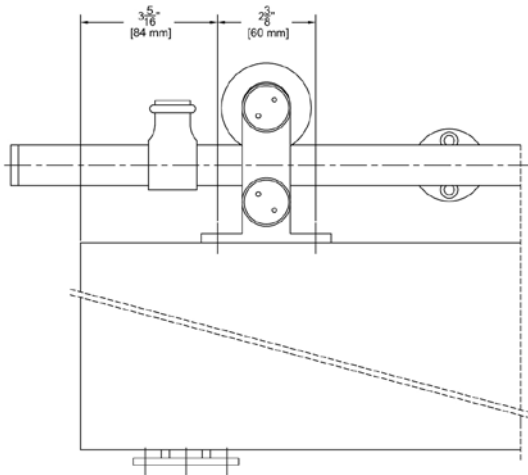
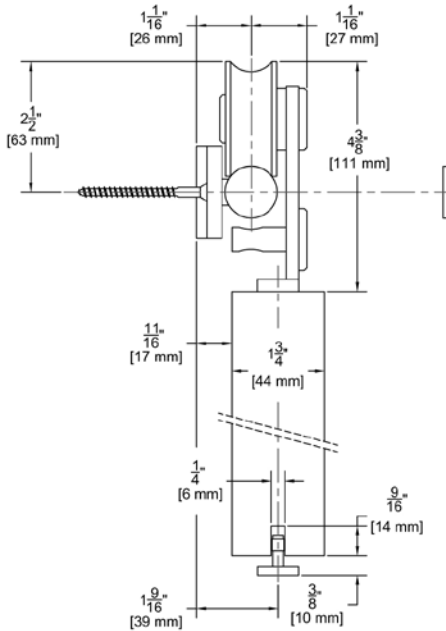

Options:

- Bottom Channel 94A
- Roller Guide 106R/94
- Mortise Guides 102N
- Polypropylene Guide Rail EPD3BL

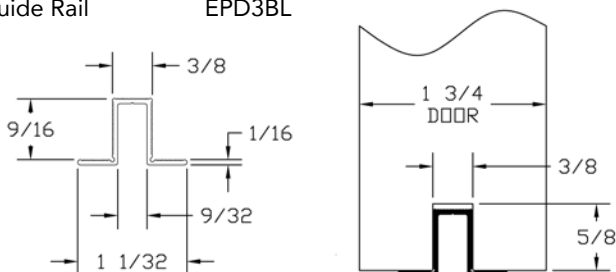

NOTE: Alternate route dimension when using optional EPD3BL

W100 Series - For Wood Doors

For Sliding Panels up to 198 lbs.

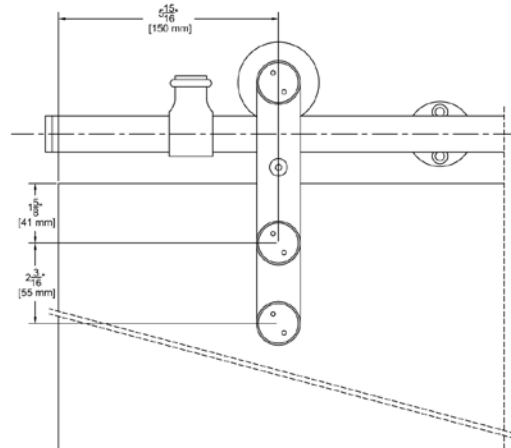
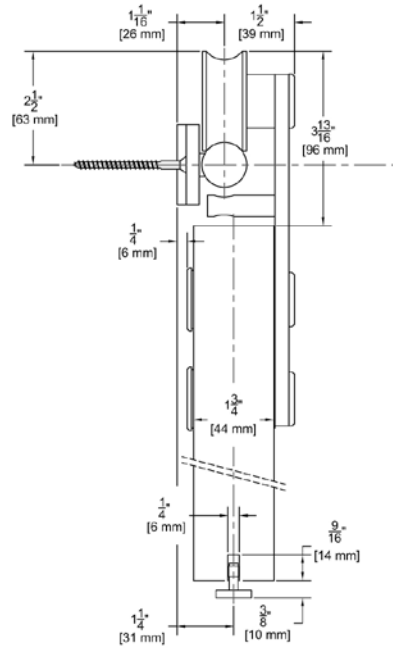

Options:

- Bottom Channel 94A
- Roller Guide 106R/94
- Mortise Guides 102N
- Polypropylene Guide Rail EPD3BL

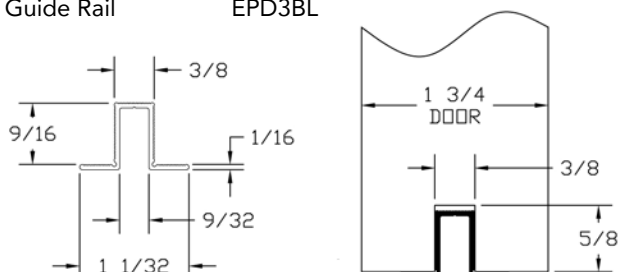

NOTE: Alternate route dimension when using optional EPD3BL

SLIDING DOOR TRACK

KV BULK PLASTIC TRACK

Low cost track for small, light doors. Fastens with brads or nails. For 1/4" or 3/4" doors only.

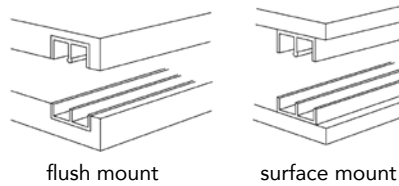
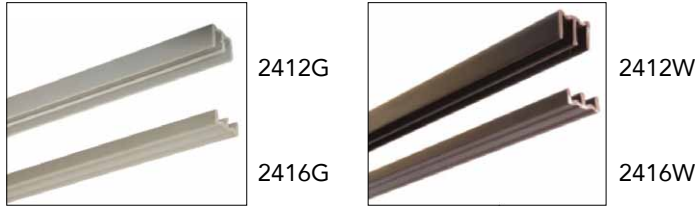

TRACK & GUIDES:
12' Lengths Only.
10 pcs. per box.

Code	Description	List
2412G-12	Guide, 12', Gray 1/4"	\$ 15.18
2412W-12	Guide, 12', Walnut 1/4"	15.18
2416G-12	Track, 12', Gray 1/4"	10.27
2416W-12	Track, 12', Walnut 1/4"	10.64

KV PACKAGED PLASTIC TRACK



Packaged set of low cost track for 1/8", 1/4", 1/2", or 3/4" doors. 10 set/carton.

Code	Description	List/ea
P2413T-4	48" Tan, 1/8" Doors	\$ 15.51
P2413T-6	72" " " "	20.58
P2417T-4	48" Tan, 1/4" Doors	14.66
P2417T-5	60" " " "	18.30
P2417T-6	72" " " "	22.68
P2417W-4	48" Walnut, 1/4" Doors	14.88
P2417W-6	72" " " "	23.95
P2419T-4	48" Tan, 3/4" Doors	19.57
P2419T-5	60" " " "	23.50
P2419T-6	72" " " "	26.39
P2421T-4	48" Tan 1/2" Doors	15.65
P2421T-5	60" " " "	18.66
P2421T-6	72" " " "	21.74

FIBRE TRACK & GLIDES

Fibre track and nylon glides for drawers and light weight sliding doors.

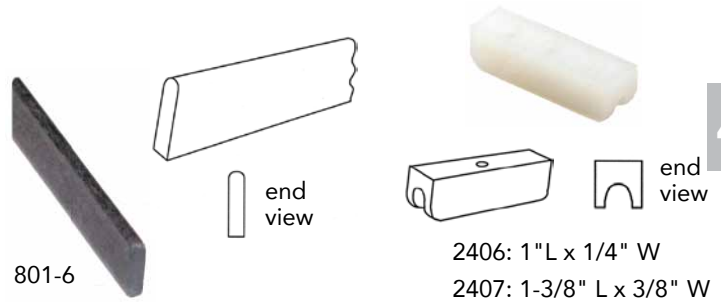

Code	Description	Ctn	List/ea
801-6	Track 1/8" x 1/2" x 6'	10 ea	\$ 12.07
2406	Nylon Glide, 1" long	50	.92
2407	Nylon Glide, 1-3/8" long	50	1.94

EXTRUDED GLASS/PANEL RETAINER

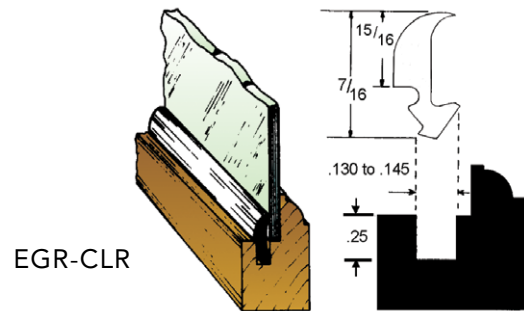

Clear, pliable plastic glass/panel retainer extrusion. Works well in cabinets with glass doors where back of door shows, and mirror-backed curios. 1000' per roll. Order by the foot.

Code	1'	100'	1000'
EGR-CLR	\$.70/ft	\$.44/ft	\$.38/ft

Amana 3 Wing Slot Cutter with 3 Wing cutter, arbor & ball-bearing. 5/32" size also used for 'biscuit-joint' cutting.

Code	Kerf	Shank	List
53407	Slot Cutter 5/32"	1/4"	\$ 36.24
53407-1*	Slot Cutter 5/32"	1/2"	54.00

* Special Order

SLIDING DOOR TRACK

EPCO SLIDING DOOR TRACK

Polybagged with all Components and Installation Instructions.

For Wood & Glass Doors

4

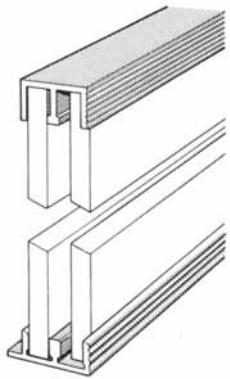

Extruded aluminum sliding door track and guide system for heavier 1/4" by-passing doors. Serrated face is designed to provide an attractive finished fascia. Screws included.

For Door Thickness: 1/4"
Door Type: Wood/Glass
Made of aluminum with a Mill Aluminum finish.

8-A-6

Code	Length	List/st
8-A-6	6'	\$ 69.77

For Wood Doors

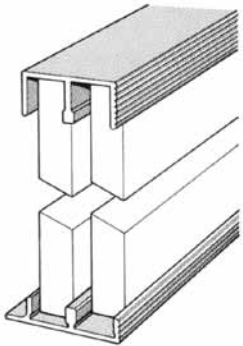

Extruded aluminum sliding door track and guide system for heavier 1/2" by-passing doors. Serrated face is designed to provide an attractive finished fascia. Button glides provide a smooth sliding action. Screws included.

Door Type: Wood
Made of aluminum with a Mill Aluminum finish.

10-A-6, 11-A-6

Code	Length	Door Thickness	List/st
10-A-6	6'	1/2"	\$ 70.96
11-A-6	6'	3/4"	73.78

KV P1092 - EZY ROLL ALUMINUM TRACK FOR SLIDING GLASS DOORS

Aluminum track assembly for sliding glass doors. Use on light, 1/4" glass doors. Consists of hardware for 1 pair of doors, overlapping 1". (Cut glass 1-1/4" less than opening vertically, allow for 1" overlap horizontally) Can be cut to size.

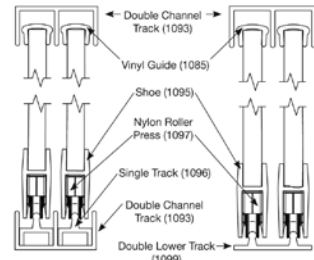
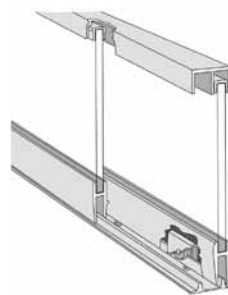

Recessed Mount

Surface Mount

Code	Description	List
P1092-3	Set with 36" Track Length	\$ 56.18 /st
P1092-4	Set with 48" Track Length	62.99
P1092-5	Set with 60" Track Length	83.92
P1092-6	Set with 72" Track Length	91.91
1097KV	Spare Nylon Rollers	2.07 /ea

KV P992 - EZY ROLL BALL-BEARING TRACK FOR SLIDING GLASS DOORS

Ball-bearing track for sliding glass doors. Use on 1/4" glass doors. Consists of hardware for 1 pair of doors, overlapping 1". (Cut glass 1-1/4" less than opening vertically, allow for 1" overlap horizontally)



P992 Track Assembly

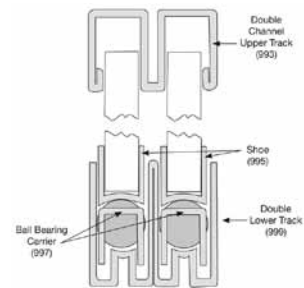

Cross Section

Code	Description	List
P992-3	Set with 36" Track Length	\$ 103.44 /st
P992-4	Set with 48" Track Length	120.29
P992-5	Set with 60" Track Length	155.41
P992-6	Set with 72" Track Length	159.88

SLIDING DOOR HARDWARE

KV SLIDING DOOR TRACK

KV track is used with KV rollers and sheaves for sliding wood doors. Note sheave numbers used with each style.



KV 455 Single track for sliding doors. With ridge up use 427, 429, 430, and 594 sheaves. With ridge down use 592 sheave. Stainless Steel finish. 12' lengths. 10 ea/ctn.



KV 467 Single track for sliding doors. Use with 427, 429, 430, 594 sheaves. Plain Steel finish. 12' lengths. 10 ea/ctn.

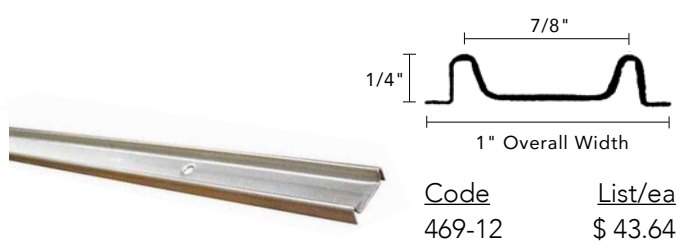

KV 469 Double track. Zinc plated steel. 1/4" high x 1" wide. 12' lengths. 10 ea/ctn.

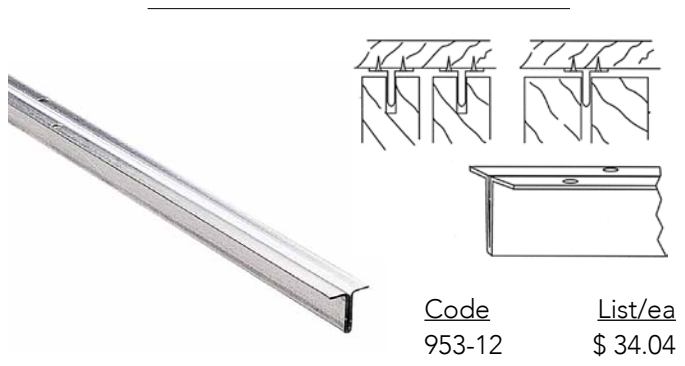

KV 953 Upper guide. Separates 2 sliding doors or use as a top guide for a single door. Pre-coated Steel. 5/8" W x 5/8" H. 12' lengths. 8 ea/ctn.

KV SLIDING DOOR SHEAVES



The 429 is a plain bearing sheave. The 427 & 430 are ball-bearing sheaves.

Code	Wheel Dia.	Frame	Ctn	List/ea
427KV	1-3/16"	2-15/16" x 1/2"	50	\$ 5.94
429	1"	2-1/4" x 3/8"	100	6.26
430KV	1-3/8"	2-3/4" x 1/2"	50	9.13

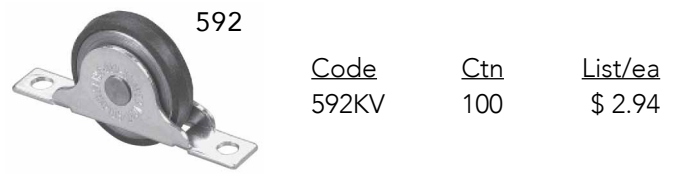

The 592 nylon sheave is for thin doors. Uses 455 track, inverted. 1-3/16" dia. roller. Frame: 9/32" x 2-1/4".

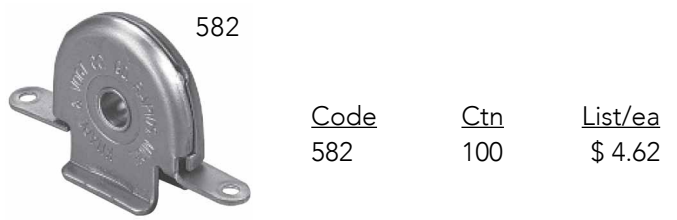

Use with 467 track. Enclosed nylon sheave roller for light doors. Case size: 1-1/4" x 5/16". Screw fastened. Flange 2-1/4" x 5/16".



The 607 is a heavy duty sheave with a side fastening plate. Round groove, ball-bearing steel wheel. Zinc plated steel frame. Use with #455, #467, & #469 track. Frame: 2-5/16" x 1-5/16", Wheel dia: 1-3/8".

4

SLIDING DOOR SYSTEM

SUGATSUNE

FLUSH SLIDING DOOR SYSTEM Special Order
MonoFlat Unison

4



- Flush Surface: Designed to close flush against surrounding walls, providing clean appearance
- Unique Movement: Door moves in first, and then slides sideways
- Clean Appearance: No bottom rails on floor required on MFU-1000-R/L

Door Width	800~1000 mm (31-1/2"~39-3/8")
Door Height	Max. 2500 mm (98-7/16")
Door Thickness	*28~30 mm (1-3/32"~1-3/16")
Door Weight	Max. 30 kg (66 lbs)
Adjustability	Depth: ±3.5 mm (1/8")
	Horizontal: ±4 mm (5/32")
	Vertical: ±4 mm (5/32")

*Can be used on door thicker than 30 mm (1-3/16") by mortising hanging bracket into the door.

- Flush Surface
Designed to close flush against surrounding walls, providing clean appearance.
- Unique Movement
Door moves in first, and then slides sideways.
- Clean Appearance
No bottom rails on floor required on MFU-1000-R/L

Note: Hardware must be installed onto a rigid frame, ceiling or wall to prevent door from falling off.

How the door moves:

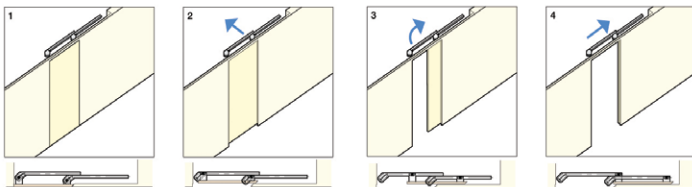

All Special Order

Code	Description	List
MFU-1000-R	For Right-Hand Opening	\$ 960
MFU-1000-L	For Left-Hand Opening	960

BI-FOLD DOOR HARDWARE



SLIDING DOOR HARDWARE

HETTICH/GRANT 1260 BI-FOLD DOOR SET

Up to 175 lbs/ door

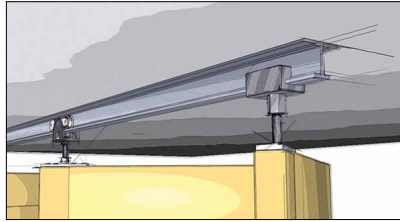

Track and hardware sold separately, one each required for assembly. Hinges not included. Accessories available.

- For door panels 1" minimum and up
- Extruded pre-drilled aluminum track
- 4 wheel carrier with nylon ball-bearing wheels
- Floor guide channel and door guide available



1260 Hardware set includes:



Accessories



TRACK ONLY

Aluminum extruded "I" Beam Track

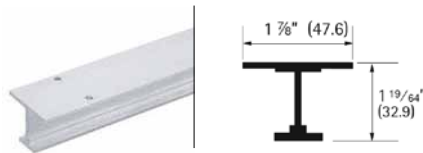

Code	Description	Ctn	List
1201-8	8' Track	5 ea.	\$ 68.39 /ea
1201-12	12' Track	5	102.60

HARDWARE SET / ACCESSORIES

1260	Hardware Set	5 sets	\$ 96.68 /st
1205	Carrier (extra)	10 ea.	38.51 /ea
1222-8	8' Guide Channel	5	30.86
1222-10	10' " "	5	38.88
1222-12	12' " "	5	46.31
1211	Guide Roller	20	3.96
1221	Door Guide	20	11.99

HETTICH/GRANT 1200 SLIDING DOOR HARDWARE

1210 for Doors up to 225 lbs.

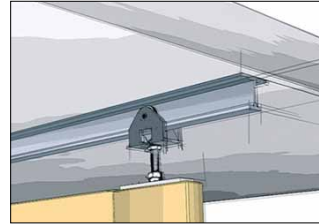

1230 for Doors up to 325 lbs.

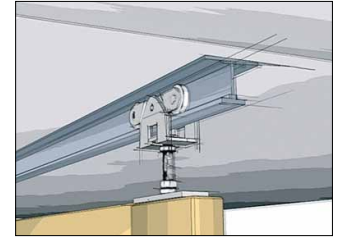

- For doors 1" and up.
225 lbs /door with 1210 hardware set,
325 lbs /door with 1230 hardware set
- Large nylon ball-bearing wheels, 1/2" vertical adjustment
- Extruded aluminum "I" beam track; jump proof design

1210 Hdwr set includes:



7015 floor guide 3" x 7/8" x 3/4"

1230 Hdwr set includes:



7015 floor guide 3" x 7/8" x 3/4"

Accessories



TRACK ONLY

Aluminum extruded "I" Beam Track

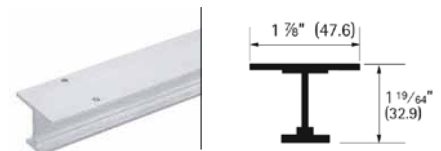

Code	Description	Ctn	List
1201-8	8' Track	5 ea.	\$ 68.39 /ea
1201-12	12' Track	5	102.60

HARDWARE SET / ACCESSORIES

1210	225 lb. Hardware set	10 sts.	\$ 68.82/st
1230	325 lb. Hardware set	10	86.51
1205	Four wheel carrier	10 ea.	38.51/ea
7015	Floor guide	10	6.39
50139	Stop - use with 1210 set	10	27.49
50140	Stop - use with 1230 set	5	35.38

BI-PASSING DOOR HARDWARE

Hettich **GRANT 7000 SERIES SLIDING DOOR HARDWARE**
Bi-passing sets for doors up to 150 lbs. each.

4

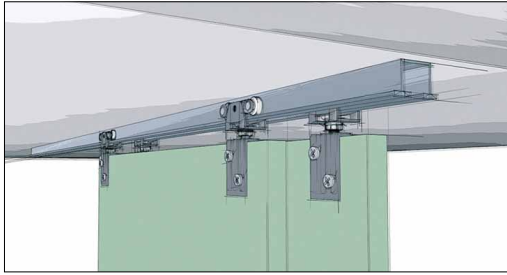

- For 1-3/8" and 1-3/4" doors up to 150 lbs.
- Steel, precision ball-bearing wheels
- Aluminum Double "I" Beam track, jump proof
- Serrations in carrier aprons permit vertical adj.
- Headroom: 1-7/8" min, 2-1/8" max
- Floor guide nylon on steel

For Doors 1-3/8"

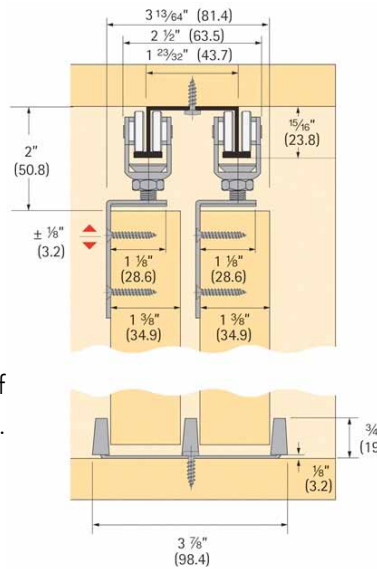

For Doors 1-3/4"

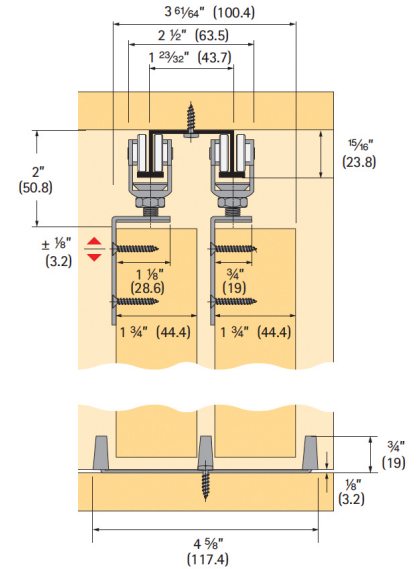

Must order Track and Hardware separately

Double Track 7003

Aluminum Extruded, pre-drilled holes



72-138 Hardware Set for 1-3/8" Doors

Set includes: (4) 7000 door carriers, (4) 7138 aprons, (1) 117 floor guide, screws, wrench and instructions



7000 Ball-bearing carrier, up to 150 lbs/door

7138 Apron 1-1/8" Offset

117 Floor guide

Code	Description	Ctn	List
7003-6	6' Track	5 ea.	\$ 44.81 /ea
7003-8	8' Track	5	58.80
7003-12	12' Track	5	89.61
72-138	Hardware set for 1-3/8" Doors	20 sts	159.58 /st
72-134	Hardware set for 1-3/4" Doors	20	174.33

72-134 Hardware Set for 1-3/4" Doors

Set includes: (4) 7000 door carriers, (2) 7034 aprons (front door), (2) 7138 aprons (rear door), (1) 118 floor guide, screws, wrench and instructions



7000 Ball-bearing carrier, up to 150 lbs/door

7034 Apron 3/4" Offset

7138 Apron 1-1/8" Offset

118 Floor guide