

TOUCH LATCHES

MAGNETIC TOUCH LATCH

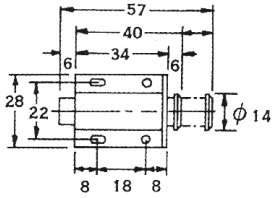

Individually polybagged with wood strike and screws.
Overall dimensions: 1-5/8" x 1-1/8".

Code	Description	Ctn	List/bg
50703-WH	White Plastic	20 bgs.	\$ 1.39
50703-BL	Black Plastic	20	1.46

DOUBLE MAGNETIC TOUCH LATCH

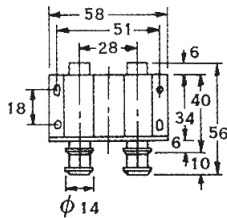

Individually polybagged with wood strike and screws.
Overall dimensions: 2-1/4" x 1-7/8".

Code	Description	Ctn	List/bg
50723-WH	White Plastic	20 bgs.	\$ 2.49
50723-BL	Black Plastic	20	2.55

TOUCH LATCH STRIKE
for Glass Doors



Length: 1-9/16"
Height: 15/16"

Code	Finish	Ctn	List/ea
50020-PB	Pol. Brass	100 ea.	\$.74
50020-BLK	Black	100	.51
50020-PC	Chrome	100	1.09

AMEROCK TOUCH LATCH

3 to 6 lbs. magnetic holding force.
Screws included.



Code	Color	Ctn	List/ea
BP32301-BR	Brown Plastic	25 ea.	\$ 5.58
BP32301-W	White Plastic	25	5.58

MAGNETIC TOUCH LATCH

Sugatsune



ML30S-BR

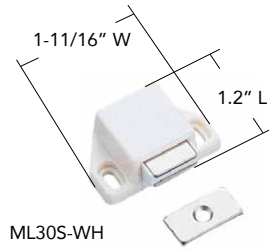

ML30S-WH

Push to open/close. For overlay door, allow a 4mm (5/32") gap between door and cabinet frame for pushing room.
Pull force: 2.6 lbs. Add .33" to length for stroke.

Code	Description	List/ea
ML30S-WH	Mag Touch Latch, White	\$ 2.93
ML30S-BR	Mag Touch Latch, Brown	2.93

MAGNETIC TOUCH LATCH

Pull force: 3.5 lbs.

Sugatsune

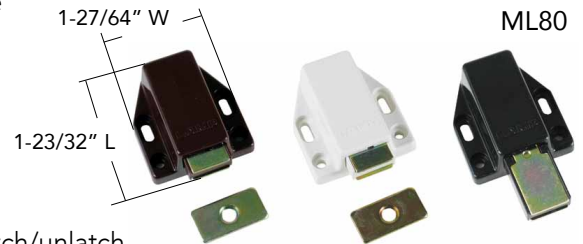

ML80

Push to latch/unlatch.
For overlay door, allow a 3.5mm (9/64") gap between door and cabinet frame for pushing room. With strikes and screws.

Code	Description	List/ea
ML80W	Mag Touch Latch, White	\$ 3.54
ML80BL	Mag Touch Latch, Black	3.54
ML80BR	Mag Touch Latch, Brown	3.54

MAGNETIC TOUCH LATCH

ML120 w/ Long Stroke for Inset Doors:

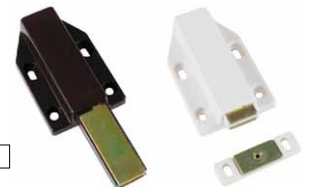
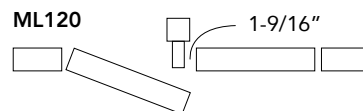
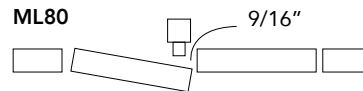

Pull force: 5.2 lbs.
1-13/16" W x 2.97" L
Add 1.57" to Length for stroke.

Push to latch/unlatch. Long stroke (40mm/1.57") for medium size doors. For overlay door, allow a 3.5mm (9/64") gap between door and cabinet frame for pushing room.

Code	Description	List/ea
ML120WH	Mag Touch Latch, White, Long stroke	\$ 4.78
ML120BR	Mag Touch Latch, Brown, Long stroke	4.78

TOUCH LATCHES

INVISIBLE LATCH

Ives CL12



CL12

Ideal for installations where no visible latch is desired. Can be installed at the top, bottom, or side of the door. Can be mortised into the stop or surface mounted to the stop. Recommended for use on larger panels or regular size doors. Latch by a slight push. A harder push releases the door. Allow 5/32" push distance to operate.

Brass and plastic construction.
Meets ANSI/BHMA A156.9, B03272.

Body: 2-1/4" Tall x 1-1/4" Wide x 7/16" Thick
Strike: 1-3/4" Tall x 3/4" Wide

Code	Finish	List/ea
CL12-26D	Dull Chrome	\$ 37.64

AUXILIARY PUSHER

for CL12 Latch

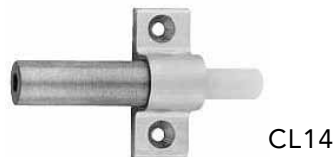

CL14

- Aids in the operation of the CL12 where hinges or surrounding conditions prevent smooth operation of doors
- Provides 1-1/16" throw
- Nylon pusher
- Brass construction
- Applies 10 lbs. to open the door

Body Dimensions:
2-15/16" Long x 1-11/16" Wide x 5/8" Deep

Code	Finish	List/ea
CL14-26D	Dull Chrome	\$ 31.54

BAINBRIDGE "TOUCH" DRAWER OPENER

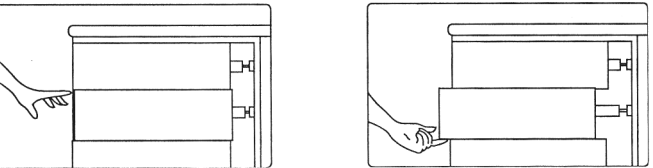

Press Drawer forward 1/8" and Drawer Opens!

Eliminates need for knobs and pulls. Not recommended for self-opening drawers. Can be mounted *through* or *on* back of drawer.

Code	Description	Ctn	List/ea
1021	Touch Drawer Opener	25 ea.	\$ 7.96

REV-A-LOCK CABINET LOCK

Rev-A-Shelf

Magnetic Lock



The lock is installed internally, leaving the outside design of the cabinet unmarred. A magnetic "key" placed on the outside of the cabinet door releases the lock. Excellent for childproofing a house. Keys and lock are packaged separately.

Code	Description	List/ea
RL-201	Lock w/strike plate	\$ 8.22
RL-202	Magnetic "key"	11.39

LATCHES

DRAW LATCHES

Sugatsune PS Series

- PS31A and PS30A designed for use with a padlock (not included)
- Polished stainless steel
- Load Cap:
PS31: 22 lbs, PS30: 33 lbs.

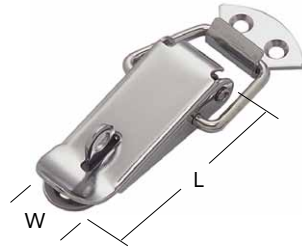

Code	Description	L	W	Ctn	List/ea
PS31A	Draw Latch, w/ hole	1-37/64"	.63"	100	\$ 9.10
PS30A	Draw Latch, w/ hole	2-3/32"	.83"	100	11.63
PS31	Draw Latch, no hole	1-1/2"	.63"	100	7.58
PS30	Draw Latch, no hole	2-3/32"	.83"	100	9.60

COMPRESSION DRAW LATCHES

Sugatsune



- Spring loaded design compensates for tolerance and vibrations.
- Provides constant hold tension for secure latching.
- Polished stainless steel

Code	Description	Ctn	List/ea
SCC-30SS	Compression Draw Latch	100	\$ 7.58
SCC-40SS	Compression Draw Latch	100	8.09
SCC-60SS	Compression Draw Latch	40	13.45

MAGNETIC CATCHES

AMEROCK MAGNETIC CATCH

For Inset Doors and other applications.
Packed with three strikes.



BP9765

Case Size: 1-15/16" L x 3/4" W x 11/16" H
Holding Strength: 10 lbs.

Three Strikes Included:

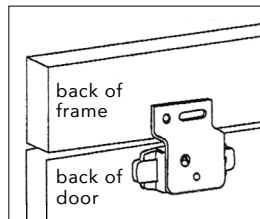

Inset Strike made for inset doors that use the Amerock full inset hinge. When doors and frames are the same thickness, alignment is automatic.

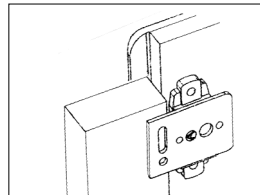

Use flat strike for 3/8" Inset Doors. Will work with all 3/8" door applications.

Polybag contains: 1 ea. magnetic catch, 3 ea. strikes (one of each shown above) and screws.

Code	Color	Ctn	List/ea
BP9765-3PT	Tan	25 ea.	\$ 3.97
BP9765-3W	White	25	4.58

Magnetic catch with inset strike only.
100 bulk/ctn.

Code	Color	Ctn	List/st
CM9765F-PT	Tan	100 ea.	\$ 4.40

MAGNETIC CATCHES

AMEROCK MAGNETIC CATCHES

Pull force: 10 lbs.
Magnetic Housing: Tan
1/2"H x 3/4"D x 2"L
Strike Plate: Zinc
3/4"H x 1-1/8"L
25 each/box.



BP9793

BP9793-PT List \$ 3.70 ea.



BP9753

Pull force: 10 lbs.
Magnetic Housing: Alum w/
Wood Grain Finish
9/16"H x 1-1/8"D x 1-15/16"L
Strike Plate: Zinc
25 each/box.

BP9753-AW List \$ 2.82 ea.

Pull force: 11 lbs.
Magnetic Housing: Aluminum
5/8"H x 1"D x 2"L
Strike Plate: Steel
3/4"H x 1-1/8"L
25 each/box, packed w/screws



BP9783

BP9783-AL List \$ 3.70 ea.



BP3473

Pull force: 10 lbs.
Magnetic Housing: Tan
1/2"H x 1-1/8"D x 2"L
Strike Plate: Zinc
3/4"H x 1-1/8"L
25 each/box.

BP3473-PT List \$ 1.27 ea.

Pull force: 19 lbs.
Magnetic Housing: Alum w/
Wood Grain Finish
13/16"H x 1-1/16"D x 2-1/32"L
Strike Plate: Zinc
25 each/box.



BP9798

BP9798-AW List \$ 5.55 ea.

SUGATSUNE MAGNETIC CATCHES

Sealed Magnetic Catch.
Hermetically sealed, ideal
for high corrosion resistance.
Magnetic force: 6.6 lbs.

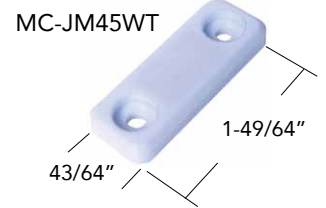

MC-JM45WT

Code	Description	List/ea
MC-JM45WT	Sealed Magnetic Catch	\$ 6.77

Sealed Magnetic Catch.
Hermetically sealed, ideal
for high corrosion resistance.
Magnetic force: 6.6 lbs.
Available in white or black.

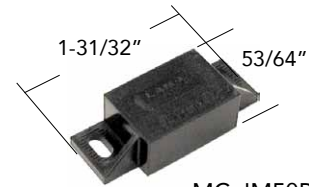

MC-JM50BL

Code	Description	List/ea
MC-JM50WT	Sealed Magnetic Catch, White	\$ 9.60
MC-JM50BL	Sealed Magnetic Catch, Black	9.60

Stainless Steel optional counterplate
for MC-JM magnetic catches. Ideal
for applications where rust is an issue.



Code	Description	List/ea
MC-JM49	Stainless Steel counterplate	\$ 1.21

Ultra Thin Magnetic Catch.
Design ideal for tight spaces.
Counterplate included.
Magnetic force: 5.9 lbs.

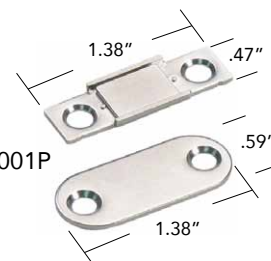

MC-YN001P

Code	Description	List/ea
MC-YN001P	Thin Magnetic Catch	\$ 6.77

Ultra Thin & Strong Magnetic Catch.
Designed with extra strong magnetic
force. Counterplate and fasteners
not included. Magnetic force: 8.8 lbs.



MC-159

Code	Description	List/ea
MC-159	Strong Magnetic Catch	\$ 4.25

MAGNETIC CATCHES

WHITE MAGNETIC CATCH

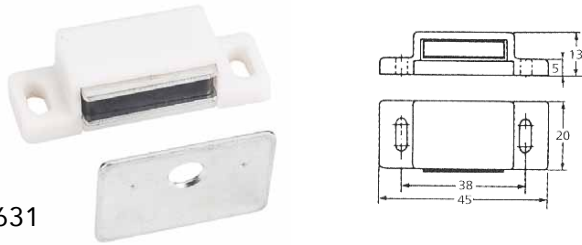

50631

Pull force: 9 lbs. Magnetic Housing: White. Strike Plate: Steel chromated. Polybagged with screws, 100 bags per carton.

Code	Color	List/bag
50631-WH	White	\$ 1.33

DOUBLE MAGNETIC CATCH



50620

2-7/8" L x 3/4" W. Pull force: 9 lbs. Magnetic Housing: Plastic White or Brown. Strike Plate: Steel chromated. Polybagged with screws, 25 bags per carton.

Code	Color	List/bag
50620-WH	White	\$ 2.48
50620-BR	Brown	2.60

ROUND MAGNETIC CATCH

Hettich

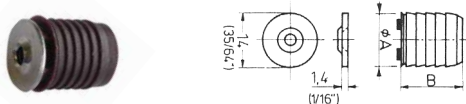

Counter plate is steel chromated (shown attached to catch). Pull force: 9 lbs. For 3/4" Board thicknesses. Bore Hole "A" is 14mm. Depth "B" is 15mm. Brown Plastic. 100 ea./box.

Code	Color	List/ea
57 273 901	Brown	\$.65

EPCO MAGNETIC CATCHES

Round Magnetic Catch for cabinet doors. Pull force: 4 lbs. Fits into 5/8" bore. Floating permanent strike. 10/ box.

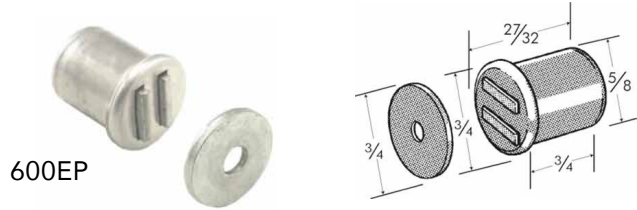

600EP

Code	Color	List/ea
600EP	Aluminum	\$ 2.43

Magnetic Catch for cabinet doors. Pull force: 6.5 lbs. Aluminum case with lifetime magnet is self-aligning to strike plate. Standard duty. 10/ box.

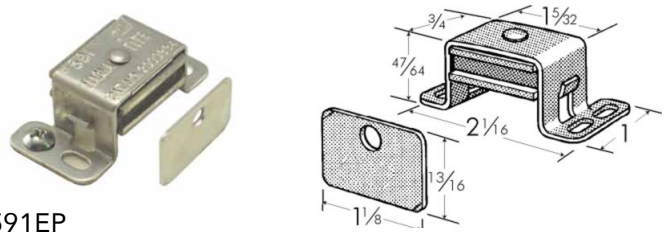

591EP

Code	Color	List/ea
591EP	Aluminum	\$ 2.27

Heavy Duty Magnetic Catch for larger doors. Pull force: 13 lbs. Aluminum case with lifetime magnet is self-aligning to strike plate.

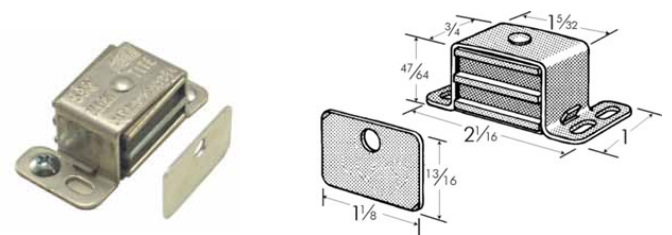

Code	Color	Ctn	List/ea
592EP	Aluminum	10	\$ 2.87
592B (Bulk)	Aluminum	250	2.66

MAGNETIC CATCHES

BELWITH MAGNETIC CATCHES

1-5/8" x 3/4".
Stat. Bronze.
25 each box.

P659STB
4.4 lb.



P659STB List \$ 2.47 ea.

1-3/4" W x 1/2" H
x 5/8" D
Brown plastic case.
25 each box.

P109-2C
4 lb.



P109-2C List \$ 3.44 ea.

2" H x 1-1/8".
Tan Plastic.
25 ea/box.

P110TP
5.5 lb.



P110TP List \$ 1.76 ea.

BELWITH DOUBLE MAGNETIC CATCH

2-1/4" W x 13/16" H
x 1" D
Stat. Bronze flanges.
Brown plastic case.
25 each box.

P651STB
6 lb.

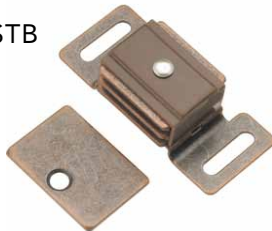

P651STB List \$ 4.61 ea.

IVES MAGNETIC CATCH

Aluminum case, double pole.
Self-aligning magnet insures
maximum pull. 50 per pack.



Case Size: 2-1/16" x 1-1/8" x 5/8".

SP325A92
6 lbs.

Code	Finish	List/ea
SP325A92	Aluminum	\$ 2.45

IVES HEAVY DUTY MAGNETIC CATCH

Heavy duty 30 lb. pull.
Furnished with one large
strike and two small
strikes.

SP326
30 lb.

Natural Aluminum Finish.
15 per pack.



SP326A92 List \$ 6.94



CATCHES

AMEROCK CATCHES



Roller Catch. 1-1/2" L x 1-1/4" W x 7/8" H. 25 each per box.

<u>Code</u>	<u>Finish</u>	<u>List/ea</u>
BP9745-2G	Zinc	\$ 4.67

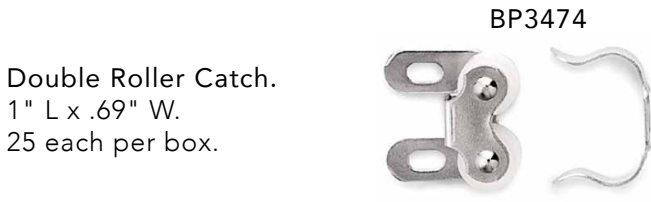

Double Roller Catch. 1" L x .69" W. 25 each per box.

<u>Code</u>	<u>Finish</u>	<u>List/ea</u>
BP3474-14	Bright Nickel	\$ 1.27



Flexi-Grip Catch. 1.25" L x .375" W. 25 each per box.

<u>Code</u>	<u>Finish</u>	<u>List/ea</u>
BP3471-2G	Zinc	\$ 1.27



Double Roller Catch. Chrome finish. 25 each per box.

<u>Code</u>	<u>List/ea</u>
143-2G	\$ 1.22

AMEROCK CATCHES cont.



Roller Catch. 1-3/4" L x 1-1/4" W x 3/8" H. Includes two strikes. 25 ea. per box.

<u>Code</u>	<u>Finish</u>	<u>List/ea</u>
BP9823-2G	Zinc	\$ 3.00

BELWITH CATCHES

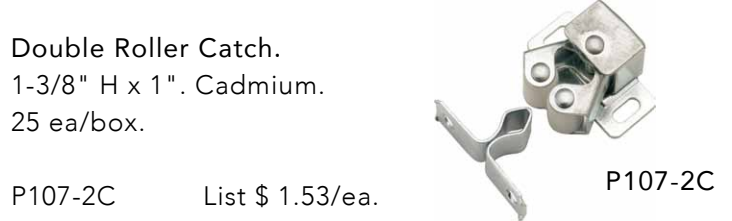

Double Roller Catch. 1-3/8" H x 1". Cadmium. 25 ea/box.

P107-2C	List \$ 1.53/ea.
---------	------------------

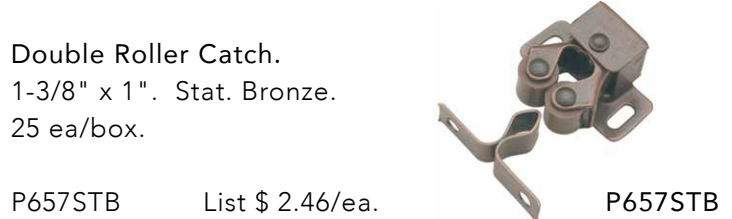

Double Roller Catch. 1-3/8" x 1". Stat. Bronze. 25 ea/box.

P657STB	List \$ 2.46/ea.
---------	------------------

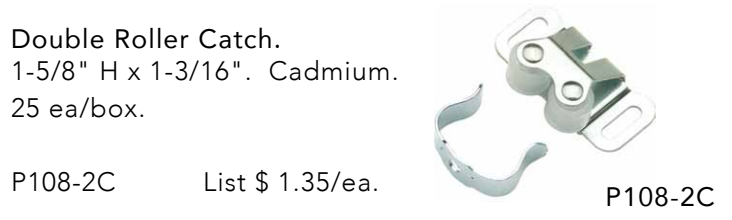

Double Roller Catch. 1-5/8" H x 1-3/16". Cadmium. 25 ea/box.

P108-2C	List \$ 1.35/ea.
---------	------------------

A & P SPRING ROLLER CATCH



Heavy duty jumbo spring roller catch. Polybagged w/screws. Polished Brass Finish. 100 ea./box.

1905-PB	List \$ 1.79/ea.
---------	------------------

6

BULLET CATCHES

CATCHES

KV BULLET CATCHES



901

Bullet catch. Varnish proof. Steel w/ brass barrel and spring. Barrel: 3/8" dia, 1/2" long. Strike: 5/8" dia. Dipped Brass. 100/box. 10 pcs. per bag.

Must order in increments of 10.

901 List \$ 1.84 ea.



902

Bullet catch. Steel w/ brass barrel and spring. Barrel: 21/64" dia, 3/8" long. Strike: 5/8" dia. Dipped Brass. 100/box. 10 pcs. per bag.

Must order in increments of 10.

902 List \$ 1.90 ea.



903

Adjustable bullet catch. Adjusts with any pointed object. Barrel: 3/8" dia, 5/8" long. Strike: 9/16" x 1-1/16". Dipped Brass. 100/box. 10 pcs. per bag.

Must order in increments of 10.

903 List \$ 4.34 ea.



905

Adjustable barrel. Barrel: 1/2" dia, 1-1/32" long. Strike: 5/8" x 1-1/4". Dipped Brass. 50/box. 10 pcs. per bag.

Must order in increments of 10.

905 List \$ 4.42 ea.

EPCO HEAVY DUTY ELBOW CATCH

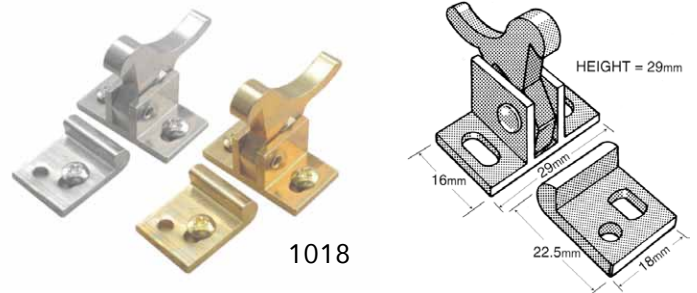

1018

Solid brass, heavy-duty elbow catch is WIC listed. Catch portion has elongated holes providing for adjustment. Strike portion has one elongated hole and one round hole. The elongated hole provides adjustment on the strike and then a screw in the round hole anchors the strike so it will not spin. Can be mounted to a laminated surface. Polybagged with screws.

Overall Base Dimensions:

5/8" x 1-1/16"

Overall Catch Height: 1-1/16"

Strike Plate: 7/8" x 11/16" x 1/4"



Listed

Code	Finish	Ctn	List/ea
1018B	Bright Brass	10 ea.	\$ 3.77
1018N	Bright Nickel	10	4.31

AMEROCK ELBOW CATCH

1-15/16" L x 1" W x 1/2" H. Steel. Bright Zinc Finish. 2 each per pack.



Code	Ctn	List/pk
BP3675-2G	25 pks.	\$ 5.16

INSET DOOR STOP

Tenn-Tex

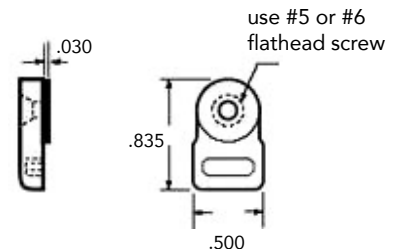

Door stop for cabinet inset doors. Clear in color. Uses #5 or #6 flathead screws (sold separately).

Code	Ctn	List/C
T230	1000 ea.	\$ 12.79

CORNA CATCHES

CORNA CSM CATCH for Corner Bi-Fold Doors



CSM catch prevents sagging of bi-fold corner doors and damage due to accidental misuse. Includes: catch, aligner and protector. Suits standard two door corner units. System 32 friendly.

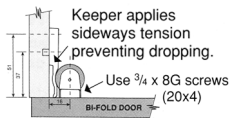
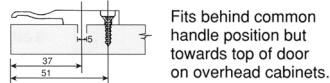
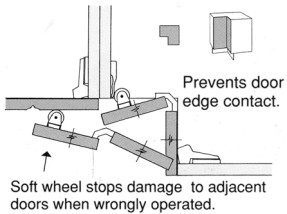
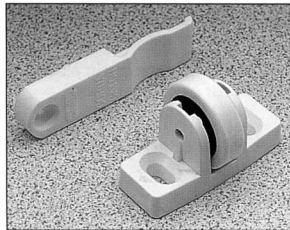

Code	Description	Ctn	List/ea
CSM	Catch for corner doors	50 ea.	\$ 3.18

CORNA FACE FRAME ADAPTER PLATE



Code	List
FFP	\$ 3.18/ea.

Pack: 10 ea.

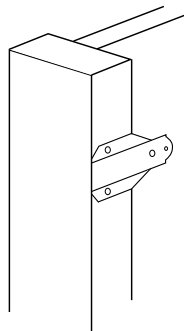

Face-frame adapter plate for easy mounting of CORNA Catch on corner unit (lazy susan) doors.

Overall Size: 2-3/16" L x 1-9/16" W

Seats the door, prevents damage to neighboring cabinetry and prevents sag of the corner unit doors.

CORNA SDP ROLL-OUT DRAWER BUMPER

SDP Bumper

Prevents damage to back of door by internal drawers and roll out shelves (suits all metal sided drawers). Only the soft wheel makes contact with the door during accidental misuse.

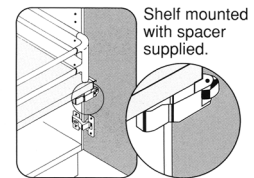
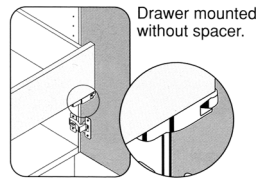
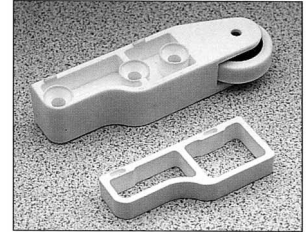

Set drawer/shelf minimum 8mm back from cabinet face edge.

Code	Description	Ctn	List/ea
SDP	Slide Door Protection	50 ea.	\$ 3.66

SELF-ALIGNING CABINET CATCH

"Bulldog"



Acts as a coupling between door and cabinet frame. Relieves strain on doors - door weight is no longer all on hinge screws. Smooth, quiet operation. Adjustable slotted steel bracket acts as a self-locating template.

Pre-assembled screw-on strike is an automatic self-marker to the door. 5-1/2 lb. pull resistance.

Code	Finish	Ctn	List/ea
65S-WH	White	100 ea.	\$.82
65S-BR	Brown	100	.81

SUGATSUNE

CATCHES

ROTARY CATCH - Sugatsune
6900, 6901

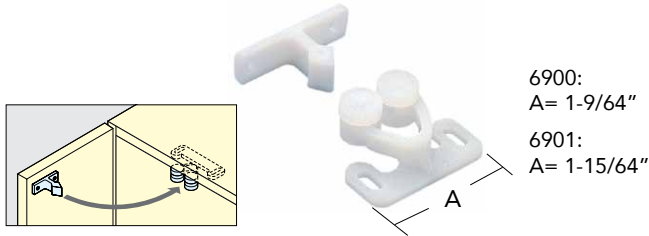

6900:
A= 1-9/64"
6901:
A= 1-15/64"

Grabs and holds doors tightly. Avail in White or Brown.
Push/Pull force of 6900: 2.4 lbs/3.5 lbs. 6901: 4.8 lbs/7 lbs.

Code	Description	List/ea
6900-WHT	Sm Rotary Catch, White	\$.30
6901-WHT	Rotary Catch, White	.38
6901-BRN	Rotary Catch, Brown	.38

KNUCKLE CATCH - Sugatsune
K-CATCH-WHT-T

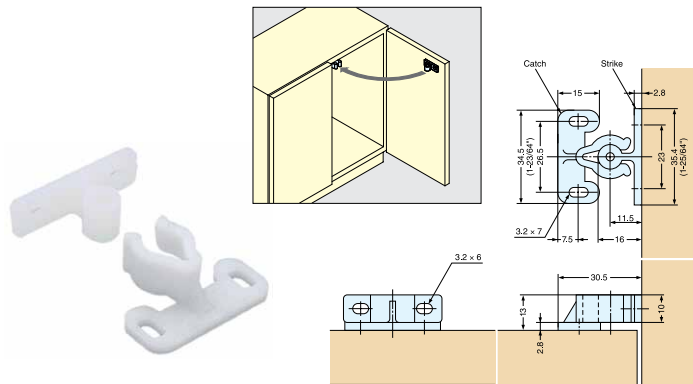

Grabs and holds doors tightly. White finish.
Push/Pull force: 12.5 lbs/15.6 lbs.

Code	Description	Ctn	List/ea
K-CATCH-WH-T	White Knuckle Catch	100	\$.85

TENSION CATCH - Sugatsune
BCT/BCTS

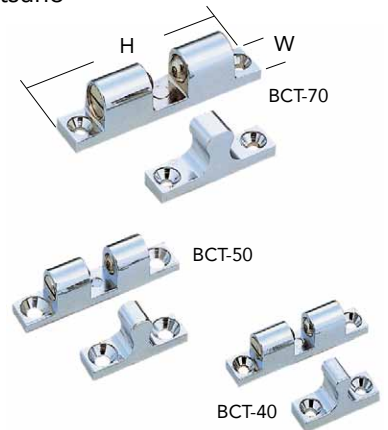

Available in Polished Chrome on Zinc alloy and in Solid Polished Stainless Steel finish.
Tension force is not adjustable.

Code	Description	H	W	Ctn	List/ea
BCT-40	Tension Catch, Lt	1-43/64"	.31"	100	\$ 5.46
BCT-50	Tension Catch, Md	1-31/32"	.39"	100	6.37
BCT-70	Tension Catch, Hvy	2-3/4"	.53"	50	10.31
BCTS-40	SS Ten Catch, Lt	1-11/16"	.31"	50	36.40
BCTS-50	SS Ten Catch, Md	1-31/32"	.39"	50	41.45
BCTS-70	SS Ten Catch, Hvy	2-3/4"	.53"	25	54.59

INSET EURO DOOR STOP - Fastcap
"Cam" adjustable inset stop

ED-BR



ED-CL



Easy to Adjust



Screw Euro Door Stop at desired depth

Designed for use with inset cabinets. Simply screw inside cabinet and rotate to adjust where you want the cabinet door to shut.

Code	Color	Ctn	List/ea
ED-BR	Brown	100 ea.	\$.20
ED-CL	Clear	100	.44



BALL CATCHES

EPCO THREE WAY BALL CATCH

Solid extruded brass. Tension adjustable from both sides provided by set screws. Strike enters from front or either side. 10/box.



Length: 1-15/16". Width: 3/8"
Projection: 9/16" strike engaged.

Code	Finish	List/ea
1012DB	Dull Brass	\$ 6.12
1012DC	Dull Chrome	6.12

Length: 2-3/8", Width: 12/32"
Projection: 5/8" strike engaged.

1013DB	Dull Brass	\$ 5.50
1013DC	Dull Chrome	9.74

BALDWIN BALL CATCH - Solid Brass

Dual adjustment ball-bearing.
Strike: 2.125" x 1.375".
Lip to center: .875".
Faceplate: 2.125" x 1".
Bore: .875" dia. x 1.25" long.
10/box.



Code	Finish	List/ea
0426-030	Polished Brass	\$ 19.21
0426-102	Oil Rubbed Bronze	19.21
0426-260	Polished Chrome	19.21
0426-264	Dull Chrome	19.21
0426-050	Sat. Brass & Black	19.21
0426-060	Sat Brass & Brown	19.21
0426-150	Satin Nickel	19.21
0426-151	Antique Nickel	19.21
0426-112	Venetian Bronze	19.21

IVES BALL CATCH - Solid Brass

Adjustable to clearance only.
Faceplate: 1-1/2" x 3/4".
Bore: 9/16" x 7/8"
Strike: 1-1/2" x 25/32".
Lip: 13/32" to center. 15/box.



Code	Finish	List/ea
SP345B3	Bright Brass	\$ 6.67

IDH BALL CATCH - Solid Brass

Dual adjustment. Lip strike is especially designed for use when catch is mounted in door.

Faceplate: 2-1/8" x 1"
Bore: 7/8" x 1-1/4"
Strike: 2-1/8" x 1-3/8"
Lip: 7/8" to center



Pack: 10 each.

Code	Finish	List/ea
12011-003	Polished Brass	\$ 8.49
12011-10B	Oil Rubbed Bronze	9.91
12011-026	Polished Chrome	9.91
12011-015	Satin Nickel	9.91
12011-26D	Dull Chrome	9.91
12011-005	Antique Brass	10.02

**DELTA BALL CATCH
Solid Brass Adjustable**

Faceplate: 2-1/8" x 1"
Strike: 2-1/8" x 1-3/8"
Bore: 11/16" x 1-1/4"
Lip: 7/8" to center



Pack: 20 each.

Code	Finish	List/ea
BC218U10B	Oil Rubbed Bronze	\$ 11.90
BC218U15A	Antique Nickel	10.72
BC218U26	Polished Chrome	10.72
BC218U26D	Dull Chrome	10.72
BC218U3	Polished Brass	8.80

ROLLER LATCHES

BALDWIN HEAVY DUTY ROLLER LATCH

Solid Brass



0430 - Latch w/Full Lip Strike
0432 - Latch w/ T-Strike

For interior doors in hospitals or where quiet operation is required. Forged brass throughout. Adjustable roller projection. Screws included.

Faceplate: 3.38" L x 1" W. Mortise Depth: 1.69".

Code	Finish	List/ea
0430-030	Pol. Brass	\$ 75.83
0430-102	Oil R. Bronze	75.83
0430-264	Dull Chrome	75.83
0430-150	Sat. Nickel	75.83
0430-260	Pol. Chrome	75.83
0432-102	Oil R. Bronze	75.83
0432-264	Dull Chrome	75.83

IVES ROLLER CATCH

Solid Brass

With standard box type strike.



336

Adjustable spring tension roller catch. Solid brass.

Faceplate: 2-1/4" x 7/8". Bore: 3/4" x 1-3/4".

Lip: 1-1/8" to center. 10 each per box.

Code	Finish	List/ea
336B3	Polished Brass	\$ 10.94
336B10B	Oil R. Bronze	14.30
336B26	Polished Chrome	13.75
336B15	Satin Nickel	13.75
336B26D	Dull Chrome	12.64

BALDWIN ROLLER LATCH

Solid Brass



0440

Adjustable tension heavy roller latch. Easily installed on thick doors. Fully adjustable from 3 lbs. to 18 lbs. Nylon rollers. Faceplate: 1.062" x 2-1/4", Bore: 1" dia. x 1.625" long, Strike: 2.75" x 1.125" Lip to center: 1.312"

Code	Finish	List/ea
0440-030	Pol. Brass	\$ 23.25
0440-102	Oil R. Bronze	23.25
0440-260	Pol. Chrome	23.25
0440-264	Dull Chrome	23.25
0440-150	Satin Nickel	23.25
0440-151	Ant. Nickel	23.25
0440-050	Sat. Brass & Black	23.25
0440-112	Venetian Bronze	23.25

IVES ROLLER CATCH

Solid Brass

With strike for simplified mortising.



335

Adjustable spring tension roller catch. Solid brass.

Faceplate: 2-1/4" x 7/8". Bore: 3/4" x 1-3/4".

Lip: 1-3/16" to center. 10 each box.

Code	Finish	List/ea
335B3	Polished Brass	\$ 13.73
335B10B	Oil R. Bronze	13.75
335B15	Satin Nickel	14.26
335B26	Pol. Chrome	13.75
335B26D	Dull Chrome	13.75

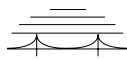

LATCHES

DELTA CABINET LOCKS

Solid Brass

Small Lock:

1-1/8" x 1-13/16"

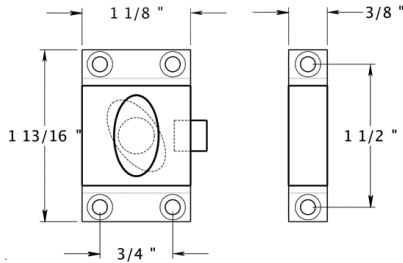

CL1532

Code	Finish	List/ea
CL1532U10B	Oil R. Bronze	\$ 22.04
CL1532U15	Sat. Nickel	22.04

Other finishes can be special ordered.

Large Lock (Special Order):

1-9/16" x 2-15/16"

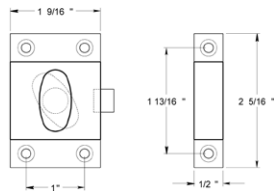

Code	Finish	List/ea
CL1580U10B	Oil R. Bronze	\$ 32.00
CL1580U15	Sat. Nickel	32.00

Special Order (other finishes available).

BERENSON CABINET LOCKS



5149-VB-P



5150-BPN-P

Designed to be either fully functional or exclusively decorative. To convert to decorative, push and hold catch in open position, then insert screw to lock catch in place. Both flat and phillips head screws provided.

2-1/16" L x 2-1/8" W x 1-1/8" H. C/C: 7/8"

Code	Finish	List/ea
5149-VB-P	Verona Bronze	\$ 39.30
5150-BPN-P	Brushed Nickel	37.10

SECRET GATE LATCHES

Designed to restrict entry into fenced off areas in banks, stores, or public buildings. (Handle does not operate a latch.)



KNAPPE & VOGT

Cast Aluminum. 3 per box.

989BR	Brass Finish	List/ea \$ 22.55
989AL	Alum. Finish	22.55

PARKER

Solid Cast Brass. 1 per box.



551PC	Chrome Plate	List \$ 29.07
-------	--------------	---------------

MASTER SAFETY HASP

Carded, exclusive pinless hinge. Ribbed for extra strength. Heavy, hard-wrought steel. Cadmium rust proofed. 12 ea/box with screws.



Code	Description	List/ea
703	3-1/2" Length	\$ 5.18
704-	4-1/2" Length	5.98

MASTER PADLOCK EYES

Hard-wrought 1/8" steel, cadmium, rust resistant. Width 2-1/8". Hole size: 3/4" x 5/8". Recessed screw seatings. Pairs individually boxed with 6 screws.

60	List \$ 3.19/pr
----	-----------------



Same as No. 60 except eye is formed at right angle. Complete with 4 unslotted bolts and nuts. 6 prs with screws per box.

60R	List \$ 3.47/pr.
-----	------------------



OLYMPUS LOCK

OLYMPUS CABINET DOOR LOCK

For Commercial Doors

Cabinet Door
Rekeyable
Deadbolt Lock

100DR

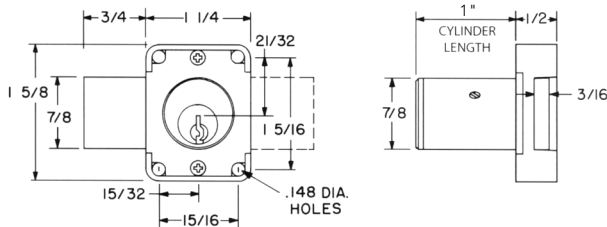

National D4292 5 pin keyway. Solid brass cylinder; pin tumbler. In stock keyed alike or different. Easily rekeyable. Includes bar strike (OL56-1). 26D finish.

Material Thickness: 7/8", Satin Chrome finish.

Code	Key #	Ctn	List/ea
100-26D78-	XXXXX	10 ea.	\$ 29.47

Available Key Numbers:

107, 915, G0001, G0002, G0003, G0004, G0005, G0006, G0007, KD (Keyed Different)

OLYMPUS CABINET DRAWER LOCK

For Commercial Drawers

Cabinet Drawer
Rekeyable
Deadbolt Lock

200DW

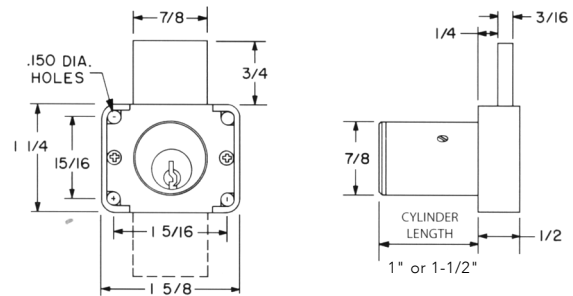

Schlage "C" keyway. Re-keyable pin tumbler lock. Pinned for 5, drilled for 6. Satin chrome (26D) finish. Stocked keyed alike or different.

Material Thickness: 7/8", 1-3/8", or 1-5/8"

Code	Key #	Mat. Thknss	Ctn	List/ea
200-26D78-	XXXXX	7/8"	10 ea.	\$ 29.47
200-26D138-	XXXXX	1-3/8"	10	29.47
200-26D158-	XXXXX	1-5/8"	10	32.51

Available Key Numbers:

7/8" = 107, 915, G0001, G0002, G0003, G0004, G0005, KD (Keyed Different)

1-3/8" = 107, 915, G0001 thru G0009, KD

1-5/8" = G0001, G0002, G0003, G0004, G0005, G0006, G0007, KD

OLYMPUS CABINET DRAWER LOCK

Commercial Cabinet Drawer Plunger Lock



300SD
Plunger Lock
Rekeyable

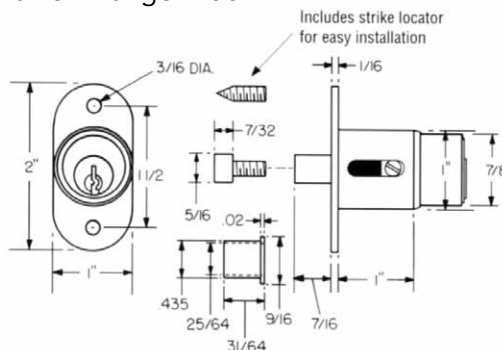

Speed release mechanism for easy rekeying. Pin tumbler cylinder drilled for 5-pin. Includes strike locator for accurate installation. Satin Chrome finish (26D). Keyed alike or different.

Material Thickness: 7/8"

Code	Key #	Ctn	List/ea
300SD-26D-	XXXXX	20 ea.	\$ 44.39

Available Key Numbers:

G0001, G0002, G0003, G0004, G0005, 915, KD (Keyed Different)

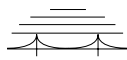

OLYMPUS LOCK

OLYMPUS PIN TUMBLER CAM LOCKS - Rekeyable

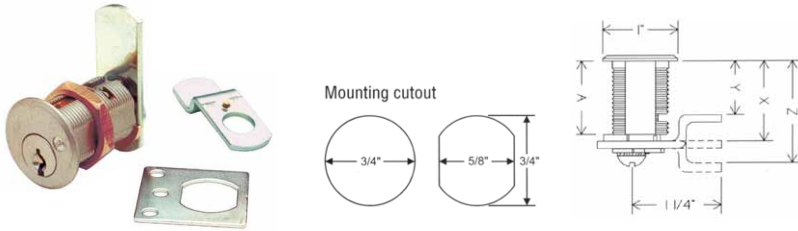

5-pin National D4292 keyway. Straight cam and offset cam included. Reversible cam, easy to install, higher security. Keyed alike or different.
Finish: 26D Satin Chrome.
Pack: 20 ea./box

	For Mat. Thickness	Straight Cam (X)	Inbent Cam (Y)	Outbent Cam (Z)	Cylinder Length (A)
DCN1	3/4"	1-1/16"	3/4"	1-3/8"	1"
DCN2	7/8"	1-3/16"	7/8"	1-1/2"	1-1/8"
DCN4	1-1/2"	1-13/16"	1-1/2"	2-1/8"	1-3/4"

Code	Mat. Thickness	List/ea
DCN1-26D-	3/4"	\$ 22.28
DCN2-26D-	7/8"	22.28
DCN4-26D-	1-1/2"	22.28

Available Key Numbers: G0001, G0002, G0003, G0004, G0005, 915, KD (Keyed Diff)

6

PADLOCKABLE CAM LOCK

DCP

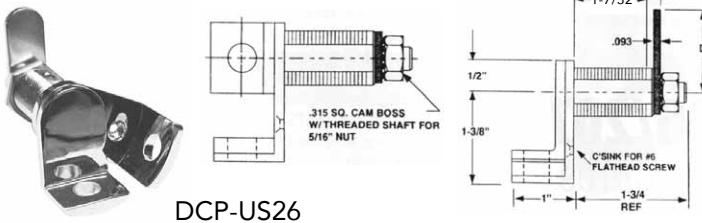

Cam Lock for use with padlock as locking device. Functions on doors and drawers. Ideal for locker applications. Max material thickness: 1-1/8". Barrel diameter: 3/4". US26 finish. Accepts most standard padlocks with a shackle diameter of 3/8" or less.

DCP-US26 15/bx List: \$ 14.94/ea.

SPACER FOR 7/8" DIA LOCKS

WP21

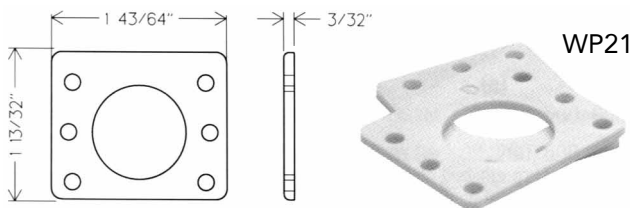

Thickness: 3/32" thick shim for flush mounting face of lock with face of cabinet. For 7/8" dia locks.

WP21 List: \$ 1.68/ea.

LARGE ANGLE STRIKE

Heavy duty angle strike.
26D finish.



12-2 List \$ 2.15/ea.

PLASTIC BAR STRIKE

10-055

1/2" bar strike.
White plastic finish.

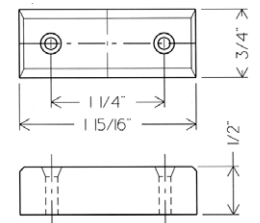

10-055 List \$ 2.31/ea.

NATIONAL KEYWAY CUT KEYS

KB-GM2MK-NP

Cut master key for National GM2 (5-pin) master key system.



KB-GM2MK-NP List \$ 3.83/ea.

CABINET LOCKS

FLUSH DOOR INSTALLATION

CompX/National



For high security installations such as cash drawers. 90° bolt throw for left and right hand doors & drawers. Key removable in locked and unlocked positions. Bore: 3/4" dia. hole. Brass construction. Pin tumbler cylinder. Dull chrome finish. Pack: 10 each.

No.	Cyl. Length	Max. Material Thickness
C8102	1-1/16"	3/4"
C8106	1-7/16"	1-1/8"
C8108	1-3/4"	1-3/8"

Code	Keying	List/ea
C8102-26D-KA915	KA#915	\$ 24.24
C8102-26D-KD	KD	24.24
C8106-26D-KA915	KA#915	24.24
C8108-26D-KA915	KA#915	24.24

LIPPED DOOR INSTALLATION

CompX/National



C8103
C8109

Same specifications as the above locks. 26D finish. Brass construction. Pin tumbler cylinder. Dull chrome finish. Pack: 10 each.

Code	Keying	Max Mat. Thickness	Cyl. Length	List/ea
C8103-26D-KA915	KA#915	7/8"	1-3/16"	\$ 24.24
C8109-26D-KA103	KA#103	1-1/2"	1-3/4"	24.24

CHEST LID LOCK

CompX/National

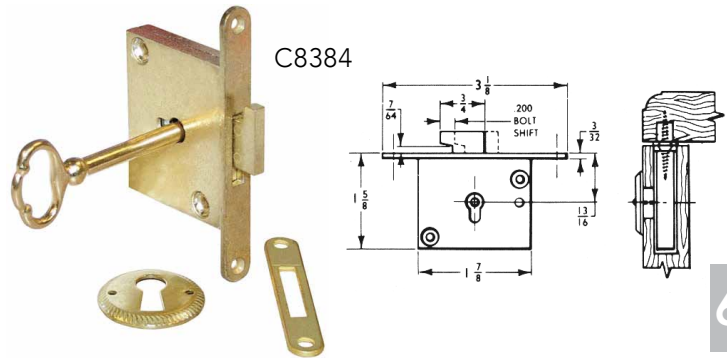

Requires full mortise and 1/2" dia. for keyhole. Hook-type bolt. Bolt travel: 5/16" .200 side shift. Key removable in locked and unlocked position. KA only. Packed with one key, screws, strikes, and keyhole escutcheons.

Code	Finish	Ctn	List/ea
C8384-3-KA	Pol. Brass	25	\$ 18.87

EXTRA STRIKES FOR NATIONAL LOCKS



C2001
Formed Strike,
no bolt hole



C2002
Formed Strike,
no bolt hole,
countersunk holes
reversed

Pack: 25 each per bag. Sold in full bags only.
Overall Size: 1-3/4" x 1/2" with 3/16" form.

Code	Finish	Ctn	List/bag
C2001-14A	Nickel Plate	1 bag	\$ 30.84
C2002-14A	Nickel Plate	1 bag	30.84

CABINET LOCKS

CompX/National Surface Mounted Drawer Locks



C8178

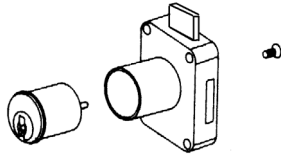

Removable Cylinder

Locks are reversible. Bore 7/8" dia. hole. Key removable in locked & unlocked positions. Brass construction. Pin tumbler. 3/4" bolt throw. Cylinder can be removed for rekeying while the lock stays in place.

No.	Cyl Length	Ctn
C8178	7/8"	10 ea
C8179	1-3/8"	10

Code	Finish	Keying	List/ea
C8178-26D-KA915	Dull Chrm	KA#915	\$ 31.64
C8178-26D-KD	" "	KD	31.64
C8178-4G-KA915	Ant. Brass	KA#915	31.64
C8179-26D-KA915	Dull Chrm	KA#915	31.64
C8179-26D-KD	" "	KD	31.64

CompX/National Surface Mounted Door Locks



C8173

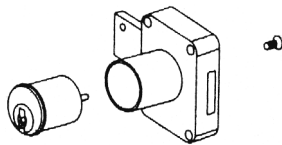

Removable Cylinder

Locks are reversible. Bore 7/8" dia. hole. Key removable in locked or unlocked positions. Brass construction. Pin tumbler. 3/4" bolt throw. Dull Chrome Finish. Cylinder Length: 7/8". Cylinder can be removed for rekeying while the lock stays in place.

Code	Ctn	Keying	List/ea
C8173-26D-KA915	10	KA#915	\$ 31.64
C8173-26D-KD	10	KD	31.64

CompX/National Door Lock: C8422

Surface mounted. Lever tumbler, for 7/8" material. 1/2" dia. Cylinder. Bolt Travel: 7/32". Cylinder Length: 7/8" Finish: Polished Brass, 25/box, keyed alike.

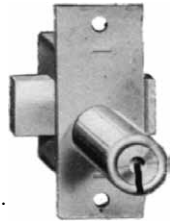

C8422-3-KA List \$ 18.39 ea.

CompX/National Door Lock: C8704

Die-cast cylinder. Steel bolt. For wood up to 15/16" thick. 7/8" dia. hole required. Bolt Throw: 11/32".

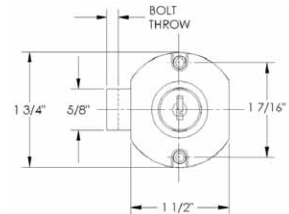

Pack: 25 each.

Code	Finish	Keying	List/ea
C8704-14A-KA415	Nickel Plate	KA#415	10.70

CompX/National Drawer Locks: C8703/C8705

Die-cast cylinder. Steel bolt. For wood up to 15/16" thick. 7/8" dia. hole required. Bolt Throw: 11/32".



C8703 for wood up to 15/16" thick

C8705 for 1-3/16" thick drawer

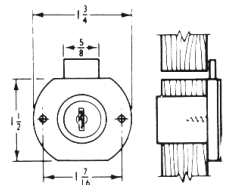

Pack: 25 each.

Code	Finish	Keying	List/ea
C8703-14A-KA346	Nickel Plate	KA#346	\$ 10.43
C8703-14A-KA413	" "	KA#413	10.43
C8703-14A-KA415	" "	KA#415	10.43
C8703-14A-KA420	" "	KA#420	10.43
C8703-14A-KD	" "	KD	10.43
C8703-3-KA413	Pol. Brass	KA#413	10.70
C8703-3-KA415	" "	KA#415	10.70
C8703-3-KD	" "	KD	10.70
C8703-4G-KA415	Ant. Brass	KA#415	10.70
C8705-3-KD	Pol. Brass	KD	11.40
C8705-4G-KA346	Ant. Brass	KA#346	11.40

CABINET LOCKS

DRAWER LOCK FOR FALSE FRONT DRAWERS

CompX/National

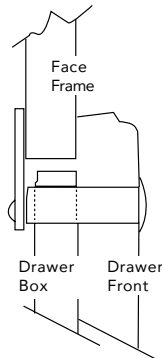

The C8060 has a cylinder length of 1-3/4" and a maximum material thickness of 1-7/16". The extra long cylinder makes this an ideal lock for false front drawers. It can also be used on cabinet doors in a lipped, overlay or flush mount. Choice of 90° or 180° cam turn. Key removable in locked and unlocked positions. Comes with two keys.

Code	Finish	Keying	List/ea
C8060-14A-KA346	Pol. Nickel	KA #346	\$ 10.65
C8060-14A-KA413	Pol. Nickel	KA #413	10.65
C8060-14A-KA415	Pol. Nickel	KA #415	10.65
C8060-14A-KD	Pol. Nickel	Keyed Diff.	10.65
C8060-3-KA413	Pol. Brass	KA #413	11.06
C8060-3-KA415	Pol. Brass	KA #415	11.06
C8060-4G-KA415	Ant. Brass	KA #415	11.06
C8060-4G-KD	Ant. Brass	Keyed Diff.	11.06

IMPROVED CAM LOCK STRIKE

Holes large enough for J085 (1/2 pan head) screws

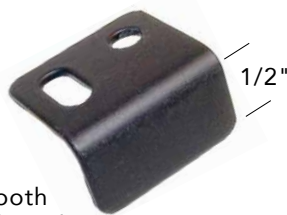

Smooth Radiused Corners

This adjustable strike has smooth radiused corners and holes large enough for J085 (1/2 x 8 Pan head) screws.

Code	Color	Ctn	List/ea
SP-101	Black	100 ea.	\$ 1.63

PADLOCKABLE CYLINDERS FOR LOCKERS

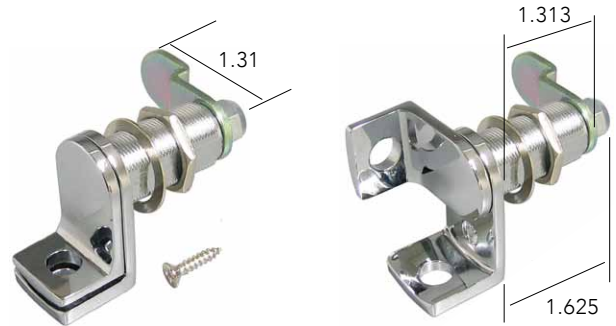

Closed position

Open position

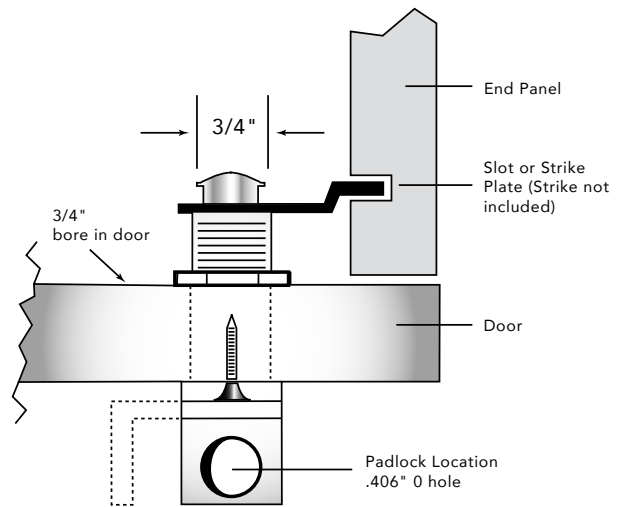

Padlockable lock cylinder can be used on sports lockers, country club lockers, band room lockers, employee lockers, etc. Each polybag includes cylinder, offset cam, nylon lock nut, body nut and body washer. Material is die-cast zinc, plated and polished. Padlock hole is .406" in diameter. Cylinder diameter is 3/4".

Code	Description	Finish	List/bg
5902	Locker latch	Pol. Chrome	\$ 16.83

6



CABINET LOCKS

CABINET CAM LOCKS FOR FLUSH OR LIPPED DOORS

CompX/National

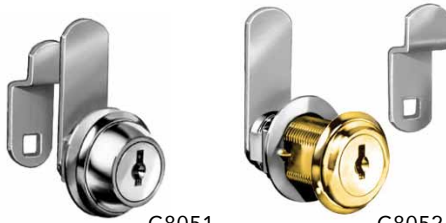

C8051

C8052, C8053
C8054, C8055

Lipped/
Overlay

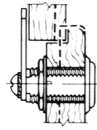

Flush

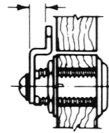

CAM FOR NATIONAL C8053 LOCK

C7014

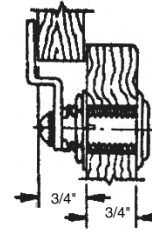

The C8053 lock using the C7014 cam accommodates overlay construction using a 3/4" thick front and 3/4" thick frame.

Code	Ctn	List/ea
C7014-2C	20 ea.	\$ 2.25

6

Lock-die cast. Supplied with two bolts: for 3/4" flush door or 3/4" door with 3/8" inset. Requires from 3/4" up to 13/16" dia. hole. Disc tumbler cylinder. 90° cam turn. Pack: 25 ea/box.

No.	Cyl. Length	Max. Material Thickness
C8051	7/16"	7/64"
C8052	5/8"	15/64"
C8053	1-3/16"	7/8"
C8054	15/16"	5/8"
C8055	1-7/16"	1-1/8"

Code	Finish	Keying	List/ea
C8051-14A-KA413	Nickel Plate	KA#413	\$ 7.57
C8051-14A-KD	" "	KD	7.57
C8052-14A-KA413	Nickel Plate	KA#413	7.57
C8052-14A-KA415	" "	KA#415	7.57
C8052-14A-KD	" "	KD	7.57
C8053-14A-KA413	Nickel Plate	KA#413	7.57
C8053-14A-KA415	" "	KA#415	7.57
C8053-14A-KA420	" "	KA#420	7.57
C8053-14A-KD	" "	KD	7.57
C8053-14A-KA346	" "	KA#346	7.57
C8053-14A-MKD	" "	KD-MKD	10.43
C8053-3-KA413	Pol. Brass	KA#413	8.03
C8053-3-KA415	" "	KA#415	8.03
C8053-3-KD	" "	KD	8.03
C8053-4G-KA413	Ant. Brass	KA#413	8.03
C8053-4G-KA415	" "	KA#415	8.03
C8053-4G-KD	" "	KD	8.03
C8054-14A-KA415	Nickel Plate	KA#415	7.57
C8054-14A-KD	" "	KD	7.57
C8055-14A-KA413	Nickel Plate	KA#413	7.57
C8055-14A-KA415	" "	KA#415	7.57
C8055-14A-KD	" "	KD	7.57
C8055-3-KA415	Pol. Brass	KA#415	8.03
C8055-3-KD	" "	KD	8.03
C8055-4G-KA415	Ant. Brass	KA#415	8.03

TUMBLER CAMS

DISC TUMBLER CAMS
CompX/National

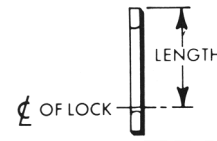
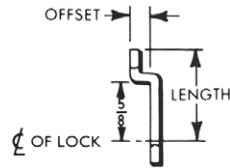

Code	Description	Length	Offset	Ctn	List
C7005-2C	Straight Cam	3"	-	25	\$ 1.47
C7014-2C	Double Formed Cam	1-5/8"	5/16"	25	2.25

6

PIN TUMBLER CAMS
CompX/National



C7104 C7105

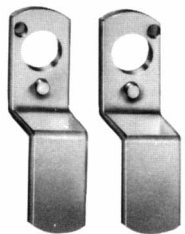
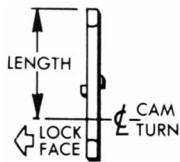



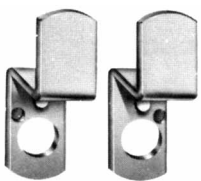
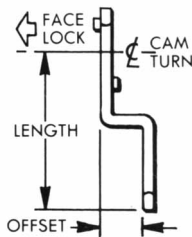



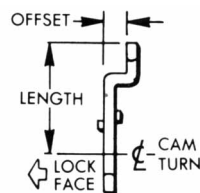

C7116 C7113



C7115 C7114



Applications - Solid lines show locked position of cam	Position of shifter on back of lock	Code	Description	Length	Offset	Qty/ Bag	List
 RH Door	 Drawer	C7104-2C	Straight Cam	3"	-	20	1.76
		*C7115-2C	Double Formed Cam	1-5/8"	7/16"	20	2.19
 LH Door	 Drawer	C7105-2C	Straight Cam	3"	-	20	1.76
		*C7114-2C	Double Formed Cam	1-5/8"	7/16"	20	2.18
 RH Door	 LH Door (bottom edge)	*C7113-2C	Double Formed Cam	1-5/8"	7/16"	20	2.20
 LH Door	 RH Door (bottom edge)	*C7116-2C	Double Formed Cam	1-5/8"	7/16"	20	2.20

* For overlay construction using 3/4" thick front and 3/4" thick frame material. Use with C8102 pin tumbler locks



KIT-LOCKS: Keyless Locking Solutions for Cabinets and Lockers



KL1006SG-KIT

5-3/8" Long
1-5/16" Wide
1-1/8" Deep

Silver Gray in color.



open position



locked position

Ideal applications:

- Public lockers, hospitals, workstations.
- Wherever keyless entries are desired
- Easily retrofitted to settings with existing cam locks

2 Modes:

- Private: same code every time. Ideal for personal use
- Public: different code each time. Ideal for lockers with multiple users

Includes:

- Setup for 3/4" thick material
- Additional parts provided for material up to 1" thick and sheet metal up to 1/4"
- Drilling template and 2 AAA batteries included
- Default vertical orientation,
- Horizontal Left and Right Hand orientations also available special order
- 2 year Guarantee by Manufacturer

<u>Code</u>	<u>Description</u>	<u>List/ea</u>
KL1006SG-KIT	Kit Lock: Vertical Electronic Cabinet Lock	\$ 100

6

SLIDING DOOR LOCKS

STERLING CABINET LOCKS

For Sliding Doors:



1068-3

For by-passing doors 3/4" to 1-3/4" thickness. KA. 6 ea./box.

Code	Finish	List/ea
1068-3	Polished Brass	\$ 17.77

For Folding Doors:

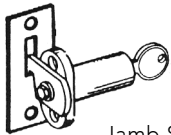

Jamb Strike for 2 Door Installation

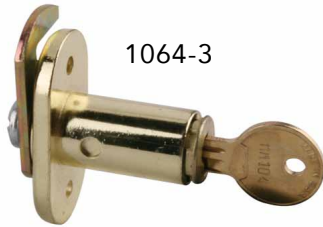

1064-3

Positive locking action locks together two center panels of any four-door, bi-fold installation. Also locks most multiple folding door installations. 5 ea/box.

Code	Finish	List/ea
1064-3	Polished Brass	\$ 21.49

KV SLIDING GLASS DOOR LOCKS

Glass sliding door lock, for up to 1/4" thick glass sliding doors. Adjustable for doors overlapping from 1" to 3-3/8".



965

Polished Nickel finish. 12 ea/box.

Code	Keying	List/ea
965KA	Alike	\$ 34.98
965KD	Different	30.25



963



Heavy duty sliding glass door lock, for doors 1/4" thick overlapping 3/4" to 3-3/8". Polished Chrome Finish. 12 ea/box.

Code	Keying	List/ea
963KA	Alike	\$ 40.58

WOOD SLIDING DOOR LOCKS

Parker

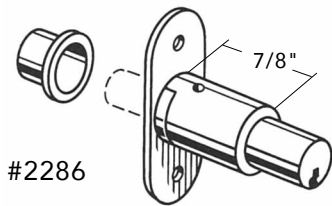

#2286

Lock Bore: 5/8"
Bolt Dia: 9/32"
Plate: 1-7/8" x 3/4"
Strike Bore: 5/8"
For 7/8" material

Elongated mounting plate, 1-7/8" x 3/4". Solid brass bolt 9/32" dia. for 7/8" material. KA only, w/screws and strike.

Code	Finish	Ctn	List/ea
2286PB	Polished Brass	10 ea.	\$ 16.79
2286PC	Polished Chrome	10 ea.	17.99

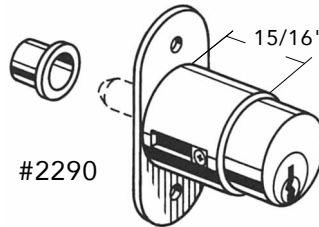

#2290

Lock Bore: 7/8"
Bolt Dia: 5/16"
Plate: 2" x 7/8"
Strike Bore: 3/8"
For 7/8" material

Pin tumbler lock mounts same as 2286. For 7/8" material. Keyed alike.

Code	Finish	Ctn	List/ea
2290PB	Polished Brass	10 ea.	\$ 12.72
2290PC	Polished Chrome	10 ea.	13.12