



## J95 HEAVY DUTY CONCEALED HINGES AND PLATES



- Load capacity: **55 lbs** w/ 2 hinges, **88 lbs** w/ 3 hinges
- Doors up to **6' 6" tall!**
- Clip on type for easy installation
- 3-way adjustment with door installed
- Requires 6 M5 or equivalent (US#10) screws: 2 screws for each hinge, and 4 screws for each mounting plate.
- Requires J95-P6T Mounting plate
- 40mm cup dia.



**J95-C24-25T**  
Self-Closing  
Overlay (20-25mm)



**J95-C24-16T**  
Self-Closing  
Half Overlay (16mm)



**J95-C24-0T**  
Self-Closing  
Inset

J95 Thick Door Inset Hinges used on 31" W x 93" H door.



**J95-P6T plate**

**New** **J95 Hinge and Plate Cover Caps - Nickel finish**



Baseplate Cover Cap      Hinge Arm Cover Cap

Heavy Duty Self-Closing hinges, 40mm cup dia.

Code	Description	Net	
		1	10+
J95-C24-25T	HD, Overlay hinge	\$ 10.41	\$ 8.99
J95-C24-16T	HD, Half Overlay hinge	11.71	10.11
J95-C24-0T	HD, Inset hinge	12.36	10.67
J95-P6T	Plate, Frameless, 3-cam	4.33	3.76
J95FO-H-NI	Full Overlay Hng Cover, Nickel	3.48	3.02
J95HO-H-NI	Half Overlay Hng Cover, Nickel	3.48	3.02
J95I-H-NI	Inset Hinge Cover, Nickel	3.48	3.02
J95-P-NI	Baseplate Cover, Nickel	3.56	3.24
J95SC-25GR	Overlay Hng Cover, Gry Plstic	2.09	1.72
J95ZC-GR	Baseplate Cover, Gry Plstic	2.77	2.26

## SALICE KITCHEN SPACE ORGANIZERS

### Fly Moon



LH Shown



- Shelves pull out independently
- Easy to Install
- Height adj. shaft 26" - 32"
- Maple melamine tray bottoms with Champagne railing
- Load Cap: 44 lbs /shelf
- Order Shelf set and hardware separately, choose RH or LH

- Standard and Soft Close versions available

Code	Hand	Min. Opening	Depth	Width
FLY40CH-R	RH	13-5/8"	16-1/32"	29"
FLY40CH-L	LH	13-5/8"	16-1/32"	29"
FLY45CH-R	RH	16"	17-3/8"	32-3/16"
FLY45CH-L	LH	16"	17-3/8"	32-3/16"
FLY60CH-R	RH	21"	18-3/4"	38-7/16"
FLY60CH-L	LH	21"	18-3/4"	38-7/16"

### Order 1 Shelf Set & 1 Hardware Set

Code	Description	Net
FLY40CH-R or L	2 shelf set, Fly Moon, 29" W	\$ 133
FLY45CH-R or L	2 shelf set, Fly Moon, 32" W	133
FLY60CH-R or L	2 shelf set, Fly Moon, 38" W	165
FLY-RH or LH	Standard Hdwr Set, RH or LH	145
FLY-RH or LH-SC	Soft Close Hdwr Set, RH or LH	185
FLY-RH-SC-60	Soft Close Hdwr Set, RH for FLY60CH-R 38" W Shelf Set	187
FLY-LH-SC-60	Soft Close Hdwr Set, LH for FLY60CH-L 38" W Shelf Set	187



## KIDNEY SHAPE SUSANS

2 Shelf Set

4WLS472



- Solid 1-5/8" Maple Rim
- Smooth radius ends
- UV cured clear coat finish
- Chrome metal hubs
- Steel Bearings

Maximum Load Control

Code	Size	Net/ea	3+
4WLS472-24-52	24"	\$ 125	\$ 123
4WLS472-28-52	28"	137	135
4WLS472-32-52	32"	157	152

**REV-A-SHELF® Bottom Mount Wood Waste Containers with Soft Open/Close**



Dovetail wood drawer with door mount brackets. Over-travel concealed 150 lb. slides. Metallic silver waste bins.



4WCBM-2430DM-2

Code	Description	Net	3+
4WCBM-2430DM-2	Two 30 Quart Bins	\$ 182	\$ 169
4WCBM-15DM-1	One 35 Quart Bin	146	137
4WCBM-18DM-2	Two 35 Quart Bins	149	139
4WCBM-1550DM-1	One 50 Quart Bin	185	173
4WCBM-2150DM-2	Two 50 Quart Bins	170	158

**REV-A-SHELF: TOP MOUNT WASTE BINS**



**35 QUART - DOUBLE BIN**

Width: 12/15", Depth: 22-3/4", Height: 17-7/8"

Two 35 quart white bins.

Code	Net	3+
4WCTM-15DM2	\$ 69	\$ 66
4WCTM-18DM2	70	67

**REV-A-SHELF BOTTOM MOUNT HAMPER**

Aluminum / Canvas Liner

- Adjustable door mount brackets
- Easy installation with only 4 screws
- Easy to clean durable molded base
- Features Rev-A-Motion™ Soft-Open/Soft-Close
- Machine washable canvas liner



16-1/16" W x 18-1/16" D x 19-5/16" H

Min Cab Opening

14-1/2" W x 18-1/4" D x 19-1/2" H

Code	Description	Net/ea
5190-15RM-117	Bottom Mount Hamper w/ Canvas Liner	\$ 185

**4WCSC Series with Soft-Close**



4WCSC - Soft Close

- Dovetail Maple construction
- Adjustable door mounting brackets
- Has 2 silver polymer containers
- Full Extension Soft Close slides

Bottom Mount Waste Containers feature heavy duty, full-extension concealed slides with Soft-Close. Dovetail construction. Comes with 35 or 50 Qt. containers. Door mount with adjustable mounting brackets.

		Min. Opening
1535DM-1	Has One 35 Quart Bin	12" W
1835DM-2	Has Two 35 Quart Bins	15" W
2135DM-2	Has Two 35 Quart Bins	18" W
2150DM-2	Has Two 50 Quart Bins	18" W

Code	Dimensions	Net	2+
4WCSC-1535DM-1	12"W x 21-3/4"D x 19-1/2"H	\$ 134	\$ 128
4WCSC-1835DM-2	15"W x 21-3/4"D x 20-3/8"H	146	141
4WCSC-2135DM-2	18"W x 21-3/4"D x 19-1/4"H	182	179
4WCSC-2150DM-2	18"W x 21-3/4"D x 24-1/4"H	164	159

**REV-A-SHELF HEAVY DUTY-MIXER LIFT**



Heavy-duty mixer lift can be attached to any custom made shelf. Has built-in shock dampeners, adjustable spring tension and upgraded support brackets. Also available in soft-close.

Holds appliances up to 60 lbs.

Code	Description	Net/ea	2+
RAS-ML-HDCR	Chrome Mixer Lift	\$ 79	75
RAS-ML-HDSC	<b>Soft-Close</b> Chrome Mixer Lift	139	133



## SALICE Waste / Recycle Pull-Outs



- Easy to Install
- Bottom Mount, Soft Close
- Smooth Undermount Slides
- Door mount brackets improve stability: 15" vertical centers
- Bins equipped with handles to lift cans up
- Depth: 19-5/8", Height: 19-1/2"

Code	Description	Net/ea
QPAM12-1C	Single 35 Qt, 12"W Base pull-out	\$ 70
QPAM15-2C	Double 32 Qt, 15"W " "	89
QPAM18-2C	Double 32 Qt, 18"W " "	102
QPAM21-2C	Double 35 Qt, 21"W " "	122

## TWO SHELF BLIND CORNER OPTIMIZER 5PSP CR Series - Chrome



**Non-handed!**

15" (15-CR), 18"(18-CR)  
Min Cab Width Opening  
20-1/4" Min Inside Cab Depth  
21" Min Cab Height Opening

5PSP15-CR unit fully extended

Code	Min Opening	Net/1	Net/2+
5PSP15-CR	15" W x 21" Ht	\$ 225	\$ 212
5PSP18-CR	18" W x 21" Ht	252	241
<b>Soft-Close</b>			
5PSP15SC-CR	15" W x 21" Ht	275	265
5PSP18SC-CR	18" W x 21" Ht	312	297



Aluminum Frame  
Glass Doors

## MacMurray Pacific

AF Series - Natural Aluminum Finish  
AF-S Series - Brushed Stainless Steel Look Finish



- Doors ship fully assembled
- Quick Delivery
- 11 profiles
- Made in USA

## New SWING CORNER

- Shelves pull out independently
- Height adjustable for overhead drawer
- Maple shelves with non-slip surfacing
- Brushed Nickel trim
- Load cap: 110 lbs. (55 lbs. per shelf)
- Minimum Installation Height: 20"
- Minimum Installation Depth: 21"



Right Hand unit shown

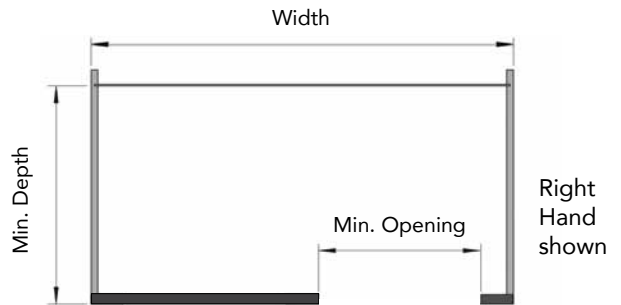

Code	Min Opening	Width	Net/ea
AS-R-15-3	16" RH	33-1/2"	\$ 236
AS-L-15-3	16" LH	33-1/2"	236
AS-R-18-3	19" RH	34-1/2"	246
AS-L-18-3	19" LH	34-1/2"	246
AS-R-21-3	22" RH	39-1/2"	257
AS-L-21-3	22" LH	39-1/2"	257



Decorative Hardware  
from  
MacMurray Pacific







**CHEF PANTRY**  
Made in Germany

**12 Minute Install**  
**Soft-Close Pantry**

**Full Depth: 22-3/4"**  
**High Capacity: 23% more storage**

**Door adjusts:**  
Height, Side, Door Warp & Tilt



Chrome Plated Baskets



Maple Melamine base, silver powder coated baskets



- 12 Minute Install
- Door adjusts for: Height, Side, Door Warp & Tilt
- Baskets Adjust in 2-1/2" steps
- Synchro-action : 265 lbs.
- Five widths : 9" - 20"
- Any height: 26" - 84"

	Height		Height
9037	25-1/2" - 37"	9067	57" - 67"
9047	37-1/2" - 47-1/4"	9076	67" - 76-3/4"
9057	47-1/4" - 57"	9091	74-3/4" - 84-1/2"

**Specify Width and Basket type when ordering:**  
**'C' for Chrome baskets or 'M' for Maple baskets**  
Example: 9076-11C.

Chrome	# of Bskts	# of				
		8-7/8"	11-5/8"	14-3/8"	17-1/8"	19-7/8"
9037-	2	\$ 390	\$ 394	\$ 400	\$ 405	\$ 409
9047-	4	391	400	412	419	430
9057-	4	392	400	413	421	431
9067-	4	404	414	424	432	442
9076-	6	476	490	506	518	532
9091-	6	480	494	510	522	536

Maple	# of Bskts	# of				
		8-7/8"	11-5/8"	14-3/8"	17-1/8"	19-7/8"
9037-	2	\$ 434	\$ 442	\$ 457	\$ 472	\$ 480
9047-	4	482	497	526	555	569
9057-	4	482	498	527	556	571
9067-	4	494	512	538	567	583
9076-	6	611	636	677	721	743
9091-	6	615	639	681	725	746

**CONCEALED COUNTER BRACKETS**

Mount to stud for extra strength

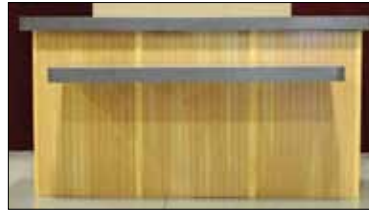

This Island was made using Extended Concealed and Concealed brackets

- Steel Construction
- Load limit range of 1,800 to 4,500 lbs. per pair
- Mounting hardware included
- All welds on reverse for easy, clean install

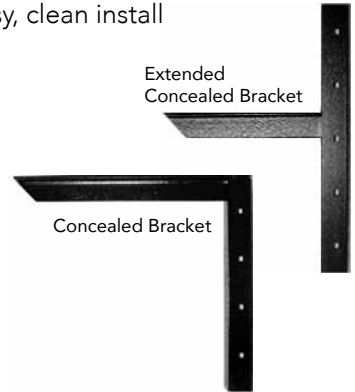
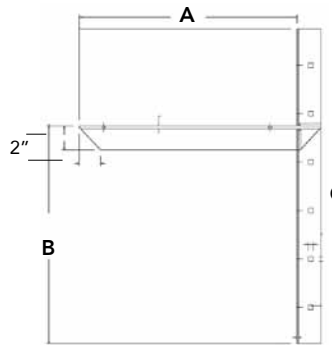

Code	A	B	C	Weight Cap / pr.	Net/ea
C18-BL	18"	18"	-	2,060	\$ 22
C24-BL	24"	18"	-	1,800	25
EC-18BL	18"	18"	26"	4,500	29
EC-24BL	24"	18"	26"	2,320	32

**FUHR 375 Waterborne Pre-Cat Lacquer**

Self-crosslinking, used for a hand rubbed, low build look in the furniture and kitchen cabinet industries.



- Self Sealing
- Durable
- Ready to Spray
- High clarity acrylic with minimal to no grain raise
- Very low VOC, Formaldehyde free and HAPS free  
VOC = 81 g/l. Passes KCMA, LEEDS, Green Seal, SCAQMD
- Weight solids: 30.2 - 32.3%

Choose sheen: 20: Low, 40: Satin, 55: Semi-Gloss, 75: Gloss

Code	Description	Size	Net/1	2+
375-XX-1	WB Pre-Cat Lacquer	1 Gal	\$ 38	\$ 35
375-XX-5	WB Pre-Cat Lacquer	5 Gal	169	165
9200-40-1	Waterborne White Varnish, Enamel Base 40 Sheen	1 Gal	39	36

Reducer: Max 10% with Distilled water

### SOFT CLOSE SIDE MOUNT BALL BEARING SLIDES



#### Enterprise

- 100 lbs. Load Capacity
- Soft Close, Soft Pull
- Full Extension
- 1/2" Side Space
- Ball Bearing
- Rear Bracket available
- Stocking 14" to 28" sizes



Soft Close \$ 7.95 /pr 22"

10 pr/Ctn. Bulk, No screws

Code	Size	Net/10	Net/50
4903-14	14"	\$ 5.98/pr	\$ 5.64/pr
4903-16	16"	6.52	6.15
4903-18	18"	7.20	6.80
4903-20	20"	7.69	7.26
4903-22	22"	8.51	7.95
4903-BRKT	Rear Bracket	.48/ea	.46/ea

### K45 ENTERPRISE FULL EXTENSION DRAWER SLIDE

Steel Ball-bearing, Load Cap: 75 lbs.

22" = \$ 3.45

- Faceframe mounting hole
- Trigger Release

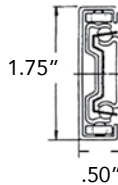

Pack: 15 pr.

Code	Size	Net 15 pr	Net 30 pr
K45-14	14"	\$ 2.54	\$ 2.23
K45-16	16"	2.91	2.55
K45-18	18"	3.27	2.86
K45-20	20"	3.50	3.18
K45-22	22"	3.95	<b>3.45</b>
K45-BR	Rear Mount Brkt	\$ 1.36/pr	



New ES10+

Longer Open Time  
Better Spray pattern  
2017 CA VOC Compliant

### ES10 & ES80 CONTACT

- No VOCs, No ODS, No Haps, Flammable
- SCAQMD Rule 1168 & OTC Compliant
- LEED Compliant
- Fast Tack Bond
- High Temp resistance > 200° F.
- Pebble spray pattern
- Postformable
- Low Odor



ES10P-13C



ES80-13C

ES10-130C Clear

ES80-140 Clear/Red

ES10-27 Clear/Red

ES80-27 Clear/Red



\*gun and hose sold separately

Code	Description	Net/ea	36+
ES10P-13C*	13 oz. 2017 Spray Adh, Cl.	6.95	<b>6.50</b>
ES80-13C	13 oz. Spray Adh, Clear (long open time)	6.45	<b>6.25</b>
ES10-CC	13 oz. Citrus Adh. Remover	6.45	<b>6.25</b>
ES10-05C	5 Gallon Pail, Bulk Clear	\$ 163	
ES10-05R	5 Gallon Pail, Bulk Red	163	
ES10-050R	52 Gallon Drum, Bulk Red	1499	
ES10-27C/R	27 lb Canister, Clear or Red	\$ 239	
ES10-130C	130 lb Canister, Clear	959	
ES80-27C/R	27 lb Canister, Clear or Red (long open time)	254	
ES80-140C/R	140 lb Canister, Clear or Red	1119	

\* Meets new 2017 CA regs. for small cans.  
Plus - improved spray tip, and longer open time.



**EVERSTRONG CONTACT CEMENTS**



These high performance industrial strength contact adhesives comply with CA VOC & OTC regulations. Water resistant & temp resistant, bonds decorative laminates and veneers, fiberglass, glass, fabrics and particle board.

**PRE-GLUED EDGEBOARDING**

Genuine Wood Veneer

Genuine Wood veneer in **250' rolls**. Pre-glued. The resin impregnated backer helps reduce splitting, tearing and checking. Unfinished. .5mm.



Pack: 12 Rolls

Code	Width	Specie	Net/Roll
KO-RWO-1316	13/16"	Rift White Oak	\$ 31
KO-WBI-1316	"	White Birch	20
KO-RBI-1316	"	Red Birch	22
KO-WL-1316	"	Walnut	23
KO-CH-1316	"	Cherry	22
KO-MAA-1316	"	Mahogany	23
KO-WO-1316	"	White Oak	21
KO-RO-1316	"	Red Oak	20
KO-VFI-1316	"	Vertical Fir	23
KO-MP-1316	"	<b>Maple</b>	<b>20</b>
KO-ASH-1316	"	Ash	23
KO-RA-1316	"	Alder	22
KO-WBI-78	7/8"	White Birch	22
KO-RBI-78	"	Red Birch	22
KO-WL-78	"	Walnut	35
KO-CH-78	"	Cherry	25
KO-WO-78	"	White Oak	24
KO-RO-78	"	Red Oak	21
KO-MP-78	"	<b>Maple</b>	<b>21</b>
KO-RA-78	"	Alder	24

**AUTOMATIC EDGEBOARDING**

Genuine Wood Veneer

Fleece-backed, Automatic Edgebanding. 7/8" Width, 500' Rolls. Unfinished. .5mm.



Code	Description	Net/Roll
K6-CH-78	Cherry, 7/8", 500'	\$ 32
K6-MP-78	<b>Maple</b> , 7/8", 500'	<b>31</b>
K6-RA-78	Red Alder, 7/8", 500'	33
K6-RWO-78	Rift Wh. Oak, 7/8", 500'	48
K6-WL-78	Walnut, 7/8", 500'	35
K6-WO-78	White Oak, 7/8", 500'	35



**MOHAWK LACQUERS 25% Solids**

**DuraCoat™ Lacquer**

Features moisture resistance, good flexibility and mar resistance. Passes KCMA testing. Low VOC.



All 5 gallon pails.

550 VOC Pre-Catalyzed	Finish	Sheen	1 pail	5
M610-24808	Gloss	80	\$ 131	\$ 126
M610-24608	Semi-Gloss	60	131	126
M610-24408	Satin	40	131	126
M610-24208	Matte	20	131	126
M610-24108	Dead Flat	10	131	126
M610-6408	White Satin	40	159	154
M610-24008	Sealer	-	131	126
M610-8008	EZ Vinyl Sealer		120	115

275 VOC Post-Catalyzed	Finish	Sheen	1 pail	5
M612-34608	Semi-Gloss	60	125	<b>120</b>
M612-34408	Satin	40	125	<b>120</b>
M612-34208	Matte	20	125	<b>120</b>
M612-34108	Dead Flat	10	125	<b>120</b>
M612-36408	White Satin	40	145	140
M612-34008	Sealer		125	120
M612-8008	EZ Vinyl Sealer		125	120
M612-3015	Catalyst: Use 16 oz. per 5 gal. Allows 6 mos. use life		6.41	

**MOHAWK EPOXY STICKS**

Restore, rebuild and repair all kinds of wood and hard surfaces. Fills loose knots.



- Easy to use, cut off only amount needed
- 3-5 minute workable time
- Fast curing, hardens in less than 20 minutes
- No shrinkage - molds to any shape
- May be sanded, drilled, stained or painted

Pack: 12 ea. 7" long, 7/8" dia, 2.7 oz. net wt.

Code	Color	Net/ea
M743-1510	Pine	\$ 6.96
M743-1530	Oak/Light Walnut	8.54
M743-1560	Walnut	8.54
M743-1520	White	6.96
M743-1570	Black	8.54
M743-1550	Cherry	8.54
M743-1580	Nat. Maple	8.54

### PORTER CABLE PCE

Laminate Trimmers, 1/4"

Includes base, 1/4" collet, edge guide.

<b>PCE6430</b>	<b>PCE6435</b>
4.6 lbs.	5.2 lbs.
Amps: 4.5	Amps: 5.6
31000 rpm	16000-35000 rpm



<u>Code</u>	<u>Description</u>	<u>Net/ea</u>
PCE6430	4.5 amp, 31000 rpm	\$ 115
PCE6435	5.6 amp, 16000-35000 rpm	140



### CMT LAMINATE TRIM BITS



<u>Code</u>	<u>Shank</u>	<u>Cut Dia.</u>	<u>Cut Length</u>	<u>Bearing Dia.</u>	<u>Net/ea</u>
806.096.11	1/4"	3/8"	1/2"	3/8"	\$ 14.52
806.128.11	1/4"	1/2"	1/2"	1/2"	14.93
806.127.11	1/4"	1/2"	1"	1/2"	15.69
806.191.11	1/4"	3/4"	1"	3/4"	21.57

### CMT CARBIDE TIPPED BORING BITS

"Fatigue proof" Swiss steel body, micrograin carbide tips, bake-on non-stick coating and honed edges. Made in Italy. Negative ground spurs on boring bits give clean cuts in melamine without chipping.

### 2 FLUTE DOWEL DRILL



<u>Size</u>	<u>RH</u>	<u>LH</u>	<u>Length</u>	<u>Net</u>
5mm	310.050.11	310.050.12	57.5mm	\$ 9.10
8mm	310.080.11	310.080.12	57.5mm	9.10
5mm	311.050.11	311.050.12	70mm	9.15
8mm	311.080.11	311.080.12	70mm	9.15

### HINGE BORING BIT

Overall Length: 57.5mm



<u>Size</u>	<u>RH</u>	<u>Net</u>
35mm	317.350.11	\$ 24.19
40mm	317.400.11	39.72

### FESTOOL RTS 400 REQ ORBITAL SANDER



Rectangular



Power.....	<b>250 watts</b>
Pad Size.....	80 x 130mm
Speed.....	6000-12000 opm
Sanding stroke.....	1/16"
Weight.....	2.6 lbs.

<u>Code</u>	<u>Price</u>
201221	\$ 260

Well suited for one-handed use. Compact design and lightweight. Step-less variable speed improves working results, and vibration-stop balancing reduces fatigue during prolonged use. StickFix Hook & Loop design for fast and easy abrasive changes between grits or to re-use abrasives. Includes re-usable dust bag and in SYSTAINER SYS 2 T-LOC.

### DTS 400 REQ ORBITAL SANDER



Power.....	<b>250 watts</b>
Pad Size.....	4" x 6"
Speed.....	6000-12000 opm
Sanding stroke.....	1/16"
Weight.....	2.6 lbs.

<u>Code</u>	<u>Price</u>
201228	\$ 260

Same as the RTS shown above but has a delta shape for sanding detailed, small, difficult to reach and angled surfaces. Includes re-usable dust bag and in SYSTAINER SYS 2 T-LOC.

### DYNORBITAL-SPIRIT™ RANDOM ORBIT AIR SANDER

*The Lightest Weight Random Orbital Sander at 1.4 lbs.*



Two orbit patterns available

- Low profile design, only 3-1/2" high.
- New muffling system rated at 75 dB.
- One-piece speed control lever.
- Horsepower: .25

<u>Code</u>	<u>Dia/Orbit</u>	<u>Net/ea</u>
59020	5" / 3/16"	\$ 149
59035	5" / 3/32"	149
59025	6" / 3/16"	149
94300	Dynaswivel: air hose swivel	15

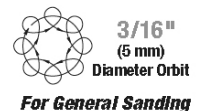





**QUADRO 4D UNDERMOUNT**

4-Way adjustment, Chrome steel bearings

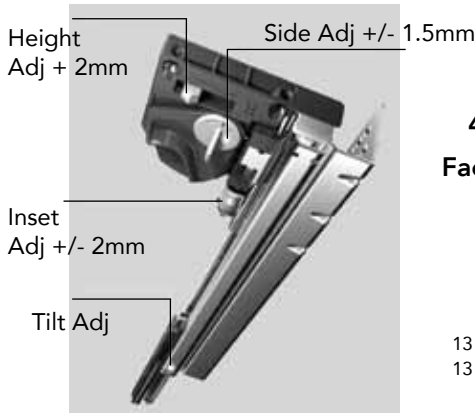

**4D Adjustments  
Face Frame Friendly**

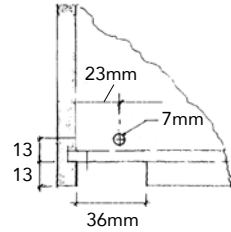

- Load cap: 100 lbs. when mounted to case side
- Silent system: Easy open, soft quiet close
- Tool-less **height, side & depth** adjust.
- Optional rear **tilt**.

Rear Tilt Bracket



Code	Size	Ctn	Net/5 pr	20 pr
9181140-41	9"	10 pr.	\$ 17.50	\$ 16.50
9181142-43	12"	10	17.50	16.50
9181144-45	15"	10	17.50	16.50
9181146-47	18"	10	16.95	16.18
9181148-49	21"	10	16.95	<b>16.18</b>
9181150-51	24"	10	31.25	27.95

Code	Description	Ctn	Net
9218980	Front Fixing <b>Clips</b> (pr), includes spacer	10	1.79 /pr
9205924 /25	<b>Tilt</b> Adjustment LH/RH	100	.76 /ea
9055093	Metal Rear Bracket	10	1.32 /st



See video at [MacMurrayPacific.com/videos#hettich](http://MacMurrayPacific.com/videos#hettich)



**4D Euro Series IW20  
Quadro - 14 Sizes**



Code	Drawer Size	Code	Drawer Size
9181186-87	11", 280mm	9181200-01	<b>18"</b> , 450mm
9181188-89	<b>12"</b> , 300mm	9181202-03	19", 480mm
9181190-91	13", 320mm	9181204-05	<b>20"</b> , 500mm
9181192-93	<b>14.2"</b> , 350mm	9181206-07	21", 520mm
9181194-95	15.4", 380mm	9181208-09	<b>22"</b> , 550mm
9181196-97	<b>16"</b> , 400mm	9181210-11	23", 580mm
9181198-99	17", 420mm	9181212-13	<b>24"</b> , 600mm

Uses 4D Clips shown above

**SALICE: Soft Close Undermount**

**New Smoother**

Full Extension Slide **\$ 13.50/pr**

**Face Frame Friendly:**

Mounts on face frame or frameless 37mm. Mounts flat on cabinet floor.



75 lbs.

**Standard Box Sizes 21", 18", 15", 12"**

Packed: 6 pr/ctn.

Code	Drawer Length	1 pr	12 pr	36+
A7555-12	12" 305 mm	\$ 15.25	\$ 14.75	\$ 14.60
A7555-15	15" 381 mm	15.25	15.09	14.95
A7555-18	18" 457 mm	15.25	14.75	13.50
A7555-21	21" 533 mm	15.45	<b>14.45</b>	<b>13.50</b>
*A6555-24	<b>24"</b> / 600mm	22.02	20.84	19.99

A710.610	Front Clips	\$ .99/pr.
A750.010	<b>6-Way</b> Adj. Ht/Side/ <b>Inset</b> Clips	2.89/pr.
AGSKXC5	Back Bracket	.39/ea.

\* Does not allow rear bracket

**FULTERER 5001ECD Soft Close Slide**

Full Extension, Load Capacity: 100 lbs.



**22" - \$ 9.95**



- Full extension, ball-bearing slide
- ECD mechanism provides impact absorbing soft-close feature
- Smooth & Quiet

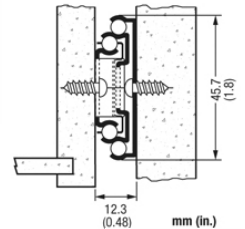

**12 - 28" In Stock**

5000BMB Bottom Mount Bracket



10 pr/Ctn. Bulk, No screws

Code	Size	10 pr	50 pr
5001ECD-16	16"	\$ 10.15	\$ 9.15
5001ECD-18	18"	10.85	9.50
5001ECD-20	20"	11.15	9.75
5001ECD-22	<b>22"</b>	11.40	<b>9.95</b>

5000MET	Rear Bracket	.95/pr
5000BMB	Bottom Mount Bracket	.50/ea



## Grass SOFT CLOSE SLIDE



- Soft-pull, soft-close
- **100 lb.** dynamic load  
125 lbs. static
- Drawers up to **48" wide**
- Made in Austria; **Grass**
- **132 lb.** Heavy Duty Dynamic
- **Anti-racking**
  - Smooth and fluid movement
  - Progressive / syncro-motion - no pickup bump
  - Minimal side sway - great for wide drawers
  - No stabilizer bars needed

## 100 lb Dynamic



Side Adjustment

\* Inset Adjustment



Rear Tilt Adjustment

### 100 lb. Dynamic Load - Height / Side Adjustment

Code	Description	Net 5 pr.	Net 20 pr.
DP-9	9" soft-close slide	\$ 21.90	\$ 20.99
DP-12	12"	17.50	16.50
DP-15	15"	17.50	16.50
DP-18	18"	16.95	15.99
DP-21	21"	16.95	<b>15.99</b>

### 100 lb. Dynamic Load - 3D: Height/Side/Tilt Adjustment

DP-9-3D	9" soft-close slide	22.97	22.33
DP-12-3D	12"	18.95	18.50
DP-15-3D	15"	18.95	18.58
DP-18-3D	18"	18.95	17.95
DP-21-3D	21"	18.95	17.95

### 132 lb. Dynamic Load - 3D: Height/Side/Tilt Adjustment

DP-18-HD	18" heavy duty slide	\$ 35.00	\$ 32.52
DP-21-HD	21"	35.00	33.37
DP-24-HD	24"	39.19	38.41
DP-27-HD	<b>27"</b>	48.78	47.39
DP-30-HD	<b>30"</b>	55.50	53.92

DP-CL/CR	Front Clips, Ht & Side	.95/ea.	.91
DP-CL/CR-3D	Rear Tilt Clips LH, RH	.58/ea.	.49
7950	Rear Metal Bracket	.78/ea.	.75
*DP-I	Inset Adjuster - Snaps on all DP slides	2.52/pr.	2.45



## QUADRO 2D UNDERMOUNT

2-Way adjustment, Steel bearings

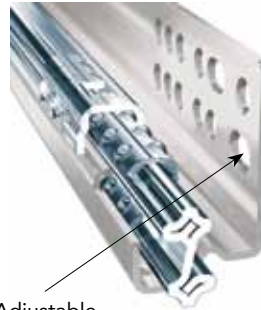

Adjustable mounting

## Quadro 100 lb. \*Dynamic Load Cycles



Less sag with all kitchen undermount drawers.

**\$ 10.99 /pr.**

### Full Extension

**24" 21" 18" 15" 12" 9"**

Smooth soft close. WIC Approved at 100 lbs / 21".  
Elongated hole pattern allows setback adjustment.  
100 lb. ANSI/BHMA Grade 1.  
All Steel Bearings.



**100 lbs.**

### 5 pr/ Ctn.

IW21 Code	Max Drawer Box Length	Min. Cab Depth	Net 5+	20
9048793	18"	18-7/8"	\$ 11.98	10.79
9048776	<b>21"</b>	21-7/8"	<b>12.50</b>	<b>10.99</b>
9026839		Front Clips, 5/8" and 1/2"	\$ 1.32/pr	
9140416		Front Clips, <b>1/2"</b> mat. only	<b>.74</b>	<b>New</b>
9055093		Rear Metal Adj. Brackets	1.29	

**DRAWERS:** Pre-Assembled & Machined for Quadro, Grass, Enterprise and Salice Slides.



**Materials:** Solid Maple, Melamine, Maple 9-ply prefinished and unfinished, 7-ply prefinished Maple, MDF and more.

Rush Service avail.  
in Bay Area.

**Construction:** Dovetail, Butt Joint or Dowelled.

**Customer Specs:** Boxes guaranteed to size within 1/32" width, 1/16" height and 1/8" depth. All dimensions are O.D.

Fax Orders to: 415-552-8577  
or email: orders@macmurraypacific.com



**ROCKY MOUNTAIN®**  
H A R D W A R E  
HANDCRAFTED BRONZE HARDWARE



door  
hinges  
grips  
window  
tile  
sinks  
cabinet  
custom  
faucets

Metro Entry Set 2-1/4 x 30"



**High Gloss Custom Door & Drawer Fronts**

Allow 5-7 Days

LUXE is an advanced decorative panel with a high gloss finish on one face, while the back is a matching decorative matte melamine in the same design.

- 3/4" MDF Core
- High Gloss Polyester Front / Matte Back
- Two Edgebanding options (solid and bi-color)
- Separate edgebanding & boards available

View All Colors and Styles and Order Form at [macmurraypacific.com/bulletins/luxe-syncron.pdf](http://macmurraypacific.com/bulletins/luxe-syncron.pdf)



**TECTUS®**  
by **SIMONSWERK**

**3-WAY ADJUSTABLE CONCEALED HINGES**



**TE-240-3D**  
88 lbs/pr.  
  
For 1.02"  
(26mm)  
Door Min.



**TE-340-3D**  
176 lbs/pr.  
For 1-1/2" (38mm)  
Door Min.  

---

**TE-540-3D**  
264 lbs/pr.  
For 1-5/8" (40mm)  
Door Min.

Completely concealed for flush doors with wood, steel or aluminum frames. Opening angle up to 180°, non-handed.

Coated Finishes



F1 -  
Satin Chrome Look



F2 -  
Satin Nickel Look

Code	Door Min	Finish	Net/ea
TE-240-3D-F1	1"	Sat Chrome Look	\$ 65
TE-240-3D-F2	1"	Sat Nickel Look	62
TE-340-3D-F1	1-1/2"	Sat Chrome Look	75
TE-340-3D-F2	1-1/2"	Sat Nickel Look	75
TE-540-3D-F1	1-5/8"	Sat Chrome Look	118
TE-540-3D-F2	1-5/8"	Sat Nickel Look	118

Other finishes available:



Rustic Umber



Matte Deep Black



Stainless Steel Look



Satin Nickel (Plated)

**TECTUS MILLING FRAME AND ROUTING TEMPLATES**



Makes door prep fast and easy. Jig clamps to door or frame to hold templates in perfect alignment.

Code	Description	Net/ea
TE-JIG	Universal Milling Frame	\$ 288

**YouTube** See video at [macmurraypacific.com/videos.html#simonswerk](http://macmurraypacific.com/videos.html#simonswerk)

Routing Templates

RT-DOOR-240	Routing Template, Door	\$ 44
RT-FRAME-240	Routing Template, Frame	44
RT-DOOR-340	Routing Template, Door	37
RT-FRAME-340	Routing Template, Frame	37
RT-540-S1	For TE-540-3D, Step 1	\$ 36
RT-540-S2	For TE-540-3D, Step 2	36
RT-540-A8-S3	For TE-540-3D-A8, Step 3	36

## SURFACE MOUNT FLAT TRACK SETS

6.5', 8' and Mini Sets - Retail View Packs



- Carbon Steel Matte Black w/ Powder coat



### Std Flat Track Set

- 6.5' and 8' Track sets
- Max. Door Weight: 350 lbs. (160 kg)
- For door thickness of 1-1/4 to 1-3/4"
- **Set Includes:**

- (5) Clamps for Fixing Track
- (2) Door Stoppers
- (1) Rail, Length 6.5' or 8'
- (2) Anti Jump Blocks
- (2) Sliding Door Rollers
- (1) Floor Guide
- Screws and Allen Key

### Mini Flat Track Set

- 5' 10" Track sets
- Max. Door Weight: 44 lbs. (20 kg)
- For door thickness of 1 to 1-3/16"
- **Set Includes:**

- (2) Door Stoppers
- (1) Rail, Length 5' 10"
- (2) Anti Jump Blocks
- (2) Sliding Door Rollers
- (1) Floor Guide
- Screws and Allen Key

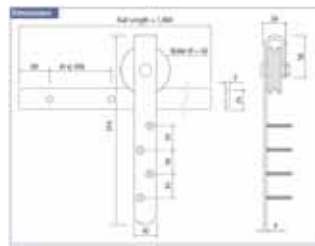
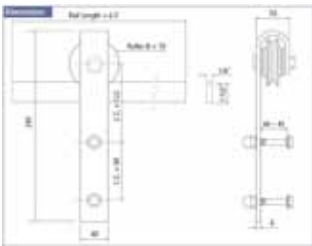

Code	Description	Net	Net/2+
FT-MB-6	Surface Mount 6.5' Matte Black Flat Track Set, Retail View Pack	\$ 115	\$ 99/st
FT-MB-8	Surface Mount 8' Matte Black Flat Track Set, Retail View Pack	119	109
FT-MINI-MB	Mini Surface Mount, Matte Black Flat Track Set, Retail View Pack	79	71
FRC-MB	Flat Rail Connectors, Matte Black	\$ 3	\$ 2/ea

## DUCASSE SLIDING DOOR SYSTEM DN 80 CF



Carrier DN 80 CF



176 lbs/door

Instop holds door - no bounce

Floor Guide

- 176 lbs /Door ANSI - BHMA Grade 1, ISO 9001
- Ultra-smooth and quiet - aluminum track and ball-bearing rollers
- Door-Track gap: 17-23mm, Door-Floor gap: 10mm
- No bounce
- One Hardware Kit per door

Code	Description	Net
013203	DN 80 CF Hardware Kit	\$ 29
021U211	DN 80 CF Track 6.5'	35
021U21-8	DN 80 CF Track 8'	40
021U21-12	DN 80 CF Track 12'	67

## Ducasse



### Soft Close for Sliding Doors!

Concealed Soft-Close for 110 - 176 lb Doors

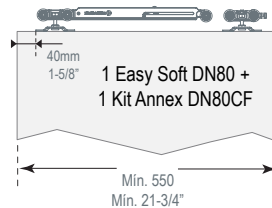

1 Direction Soft with hangers for 1 door

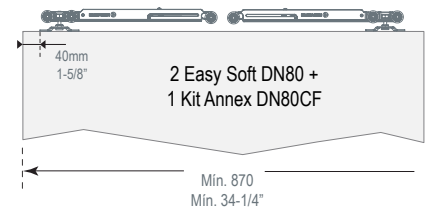

2 Direction Soft with hangers for 1 door

Code	Description	Net
10107026485	Easy Soft DN 80 Kit	\$ 65
10107026486	Annex Kit DN 80 CF	7



RETURN SERVICE REQUESTED

PRSRT STD  
U.S. POSTAGE  
**PAID**  
San Francisco, CA  
PERMIT NO. 200

## August - September 2017 Specials

Order Desk (800) 244-1455 Fax (415) 552-5840  
Email [orders@macmurraypacific.com](mailto:orders@macmurraypacific.com)  
On the Web [www.macpac1.com](http://www.macpac1.com)

## **SALICE** SWITCH HINGE 3 Settings

**\$ 2.09 /ea.**

- Soft Close with **3 Door Settings:**
  - Heavy** (with '+' sign showing on both hinges)
  - Medium** (with one '+' sign and one '-' on each hinge)
  - Light** (with '-' sign showing on both hinges)

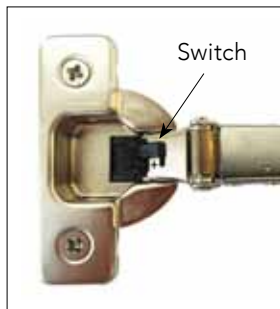

Switch in Heavy '+' position

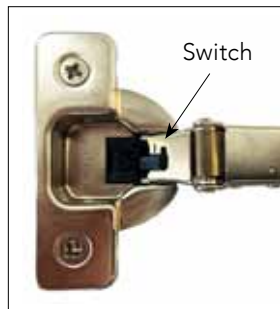

Switch in Light '-' position

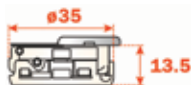

13.5 (17/32")  
cup depth

### Switch Hinge, Soft Close - with Dowels

Code	Description	Net 50	300
C7R6AG9	110°, Full Overlay	\$ 2.19	<b>\$ 2.09</b>
C7R6DG9	110°, 1/2" Overlay	2.19	<b>2.09</b>
C7R6GG9	110°, Half Overlay	2.19	<b>2.09</b>
<b>C7R6PG9</b>	<b>110°, Inset</b>		

**Coming Soon!**



See videos at  
[macmurraypacific.com/videos.html#salice](http://macmurraypacific.com/videos.html#salice)

### Contents:

Adhesives: Newstar Everstrong	5
Barn Door (Flat Track) Hardware	11
CMT Bits	7
Concealed Counter Brackets	4
Drawer Slides, Side Mount	5,8
Drawer Slides, Undermount	8,9
Ducasse Door Systems	11
Edgebanding	6
Element Designs	3
Fuhr Lacquer	4
Hettich Quadro Slides	8,9
Luxe High Gloss Panels	10
Mohawk Lacquer / Wood Repair	6
Orbital Sanders: Festool, Dynabrade	7
Porter Cable Laminate Trimmers	7
Rev-A-Shelf Products	1-3
Salice Flymoon Kitchen Organizers	1
Salice Switch Hinges	12
Swing Corner Kitchen Storage	3
Sugatsune Hinges & Plates	1
Tectus Hinges / Templates	10
Vauth Sagel Pantry Pull-Outs	4
Waste / Recycle Pull-Outs	2-3