



# FLAT TRACK

BY LEATHERNECK HARDWARE



---

Hotels | Office Space | Baths | Barn Doors | Restaurants | Galleries | Lofts | Kitchens  
Rustic Homes | Closets | Recessed Storage





**FLAT TRACK**  
BY LEATHERNECK HARDWARE

MADE IN  
  
U. S. A.

Flat Track Hardware by Leatherneck Hardware styling dates back to the turn of the century when it was used for barn doors, warehouses and in industrial settings. Today the award-winning hardware, with its unique look and versatile finishes, is perfect for many space-saving interior and exterior applications.

We personally design and manufacture all of our hardware and specialize in custom projects. Whether new construction, repurpose, remodel, repair or retrofit, we have over 35 years of creative solutions for any door hardware project.

Our sliding hardware has been featured everywhere from HGTV to The Ellen Show, but what means the most to us is hearing that our hardware was even better than our customers expected. They tell us the difference is in our quality – materials, craftsmanship and experienced service.

***“What I like is the form follows the function. The beauty lies in the raw simplicity.”***

***- Cavin Costello,  
Chief Designer, The Ranch Mine***

- Interior and Exterior Applications
- Commercial and Residential
- Smooth and Solid Operation
- Highest Quality and Workmanship
- Space Saving
- Capacities 400 lb and 800 lb Units
- Complete Kits or Individual Components
- Single Slide and Bi-parting Openings

## Custom Solutions

We excel at designing customized solutions in partnership with our customers. No matter the design idea or challenge, our team of innovators can develop a sliding hardware answer that makes every space unique and functional.



### Design

The hardware is available in clean, simple styling or can be reimagined to fit any application perfectly.

### Finishes

The hardware is available in many standard finishes. Don't see what you want? Our team continues to develop show-stopping finishes in every painted color on the spectrum, a variety of textures and our new graphics applications.

### Applications

Custom track lengths and unique design ideas help our customers save space in the most unconventional places.



# Hangers

400 lb Door Track  
142 Series Hanger Styles



401 Arrowhead



402 Straight



403 Horseshoe



403 DBHH  
Double Bar Horseshoe



407 Top Mount

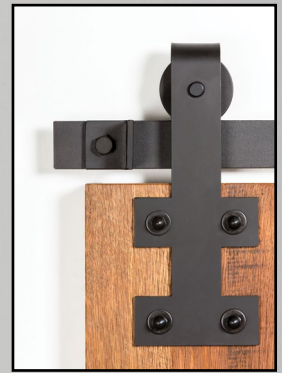

409 I-Shape



410 Teardrop



411 Wide Teardrop

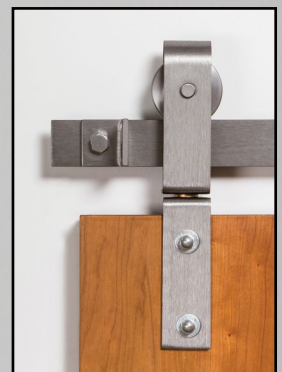

413 Swivel

# Hangers

800 lb Door Track  
144 Series Hanger Styles



404 Teardrop



405 Straight



406 Industrial  
Wide Tear Drop



142 series hanger is 11" in length

144 series hanger is 21" in length

# Track

*Two sizes to fit all needs*

142 series for doors up to 400 lbs

144 series for doors up to 800 lbs

# Finishes



00 Flat Black



25 Unfinished



27 Clear Coated



30 Machine Polished



40 Mill Finish  
Stainless Steel



50 Brushed  
Stainless Steel



60 Weathered Rust



80 Painted Bronze

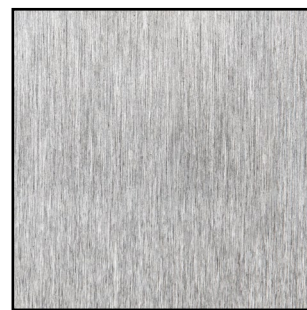

90 Brushed Nickel Finish

## Custom

Custom finishes are common at Leatherneck Hardware. We continue to develop and create solutions that are as unique as our customers. Don't see what you are looking for? Be sure to ask!



# Graphics Series

With our new Graphics Series, the sky's the limit for finish ideas. This series gives your Flat Track by Leatherneck Hardware some flair. Customers can choose to add anything from camo for a rustic room to a leather-look – and everything in between. The durable Graphics finish can be added to any Flat Track kit order.

The Delrin hanger wheels, hanger pin, track mounting screws, anti-jumps and hanger fasteners are in black.

Track lengths and lead times may vary.



## Graphic Samples



Army Camo

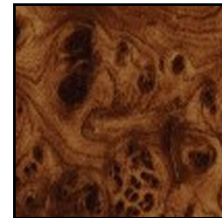

Knurl Wood



Walnut



Diamond Plate

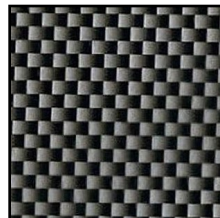

Carbon Fiber



Light Wood Grain



White Marble

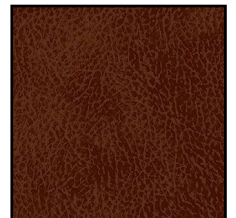

Leather

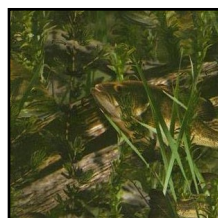

Fish Camo



Pink Camo



Tan Camo

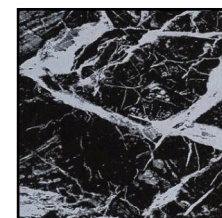

Black Marble

# Signature Accent Series

The Signature Accent Series creates a unique contrast of finish and color for the Flat Track line. Customers choose the two colors – one for the Base, the other for the Accent. The Base color is applied to the hangers, stops and spacers. The Accent color is applied to the track and overlay.

The custom color overlay acts as a washer under the acorn nut that fastens the hanger to the door - creating a unique offset of color.

Delrin hanger wheels, track mounting screws, anti-jumps and hanger fasteners are in black.

Signature Accent Series colors can be added to any Flat Track by Leatherneck Hardware kit.

## Color Pallet

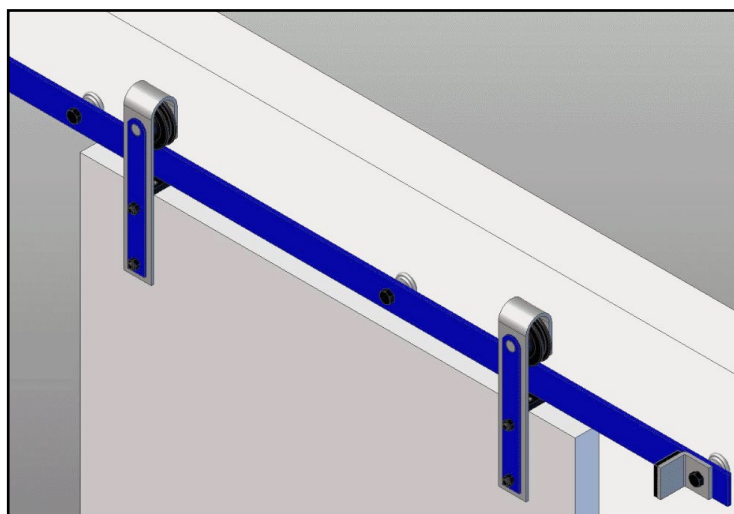
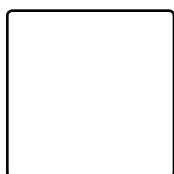

Examples from our wide range of color options. Actual colors may vary.



# Wheels

All of our wheels are precisely machined and feature sealed ball bearings that are lifetime lubricated. Wheels are available in all finishes.



3" Standard Steel Wheel and 2-1/2" Low Profile Steel Wheel



3" Quiet Wheel Made from a durable polymer material

## Standard Steel Wheel

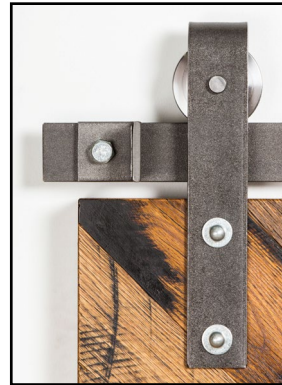

## Low Profile Wheel



## New Aluminum Spoke Wheels 402S Series

The aluminum spoke wheel is a highly stylized 6" wheel to enhance the design of your Flat Track system. This style wheel is interchangeable with the 142 series.



5-Spoke



10-Spoke



Bullet

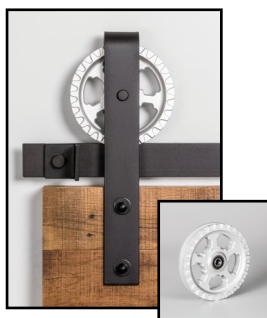

Gear Head



Mark II



Six Shooter



Texas Star

## Accessories



Close-Ease  
(0119-0092)

Soft-closing mechanism to close doors silently and smoothly. The mechanism, concealed behind the track, catches the activator for gentle, even closing. Door weight capacity of 150 lbs. (Pictured from rear view)



Privi-Loc  
(0119-7019)

Sliding door locking system with safety opening feature. Jamb mounted.



Cast Iron Raised  
Bow Handle  
(0117-0054)



Cast Iron Lower Profile  
Bow Handle  
(C95-607)

*Finish: Standard Black*



Cast Iron Flush  
Pull Handle  
(0117-0099)



Stainless Steel Flush  
Pull Handle  
(C95-612)





Track Mounting Screws  
(0316-0046)

One per spacer.  
*Finish: Black Oxide  
(also in Zinc Oxide)*



Stop for #142 Track  
(0115-0022)  
Fixed on the end hole.



Reversible Stop  
(0119-0099)

Low profile track stop that provides flexibility in door stop placement, extending the movement of the door. It can be used with single, bi-pass and bi-parting door systems.



Splice Plate for #142 Track  
(0115-0021)

Bracket used to hold two ends of track together.

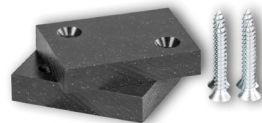

Anti-Jump Block for #142 Track  
(0115-0033)

Fixed on top of door to keep door on track.



Spacer for #142 Track  
(0115-0020)

Flange against wall and behind track.

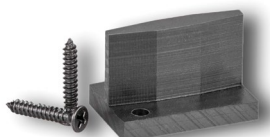

Bottom (FIN) Guide (Black)  
(0119-0030)

Bottom floor guide to secure door.  
Floor mounted.



Cradle Guide  
(0120-0001)

Designed for lightweight doors that do not require a mortise cut along the bottom. It cradles the bottom of the door for vertical wall alignment.

# Retail Kits

Flat Track by Leatherneck Hardware is available in standard length kits. Flat Track kits are easy to order, warehouse, and display in any retail setting. The kits include all components needed for a standard size opening. Kits are available in all finishes with track lengths of:

5 ft | 6 ft | 7 ft | 8 ft

*Custom track lengths, finishes, hangers and bi-parting kits are available upon request.*

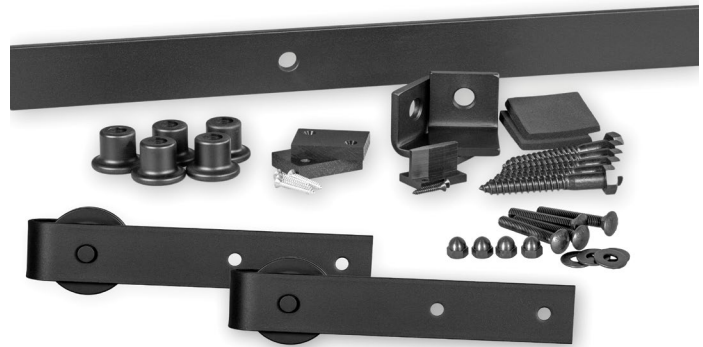

## Retail Track and Component Kit Includes:

- 2 Flat Track Hangers with Mounting Hardware
- 1 Flat Track with 4-7 Spacers and Track Mounting Screws  
*(quantity varies by size of track)*
- 2 Door Stops with Cushions
- 2 Anti-Jump Blocks
- 1 Bottom Fin Guide
- Easy-To-Follow Instructions

*Bi-parting openings require multiple kits and splice plate. Door openings wider than the specified kit width will require multiple tracks and splice plate.*



## Retail Showroom Display

Leatherneck Hardware offers a solid wood Showroom Display for the Flat Track Hardware line. The compact display may be wall mounted or used on a counter top.

### Display measures

**23-1/2" wide x 25" tall x 11-1/2" deep**

### Display includes:

Solid Wood Display Board with Mounted Track

Removable Base

Flat Track Hangers - one Flat Black finish and one Brushed Nickel finish

Print Materials

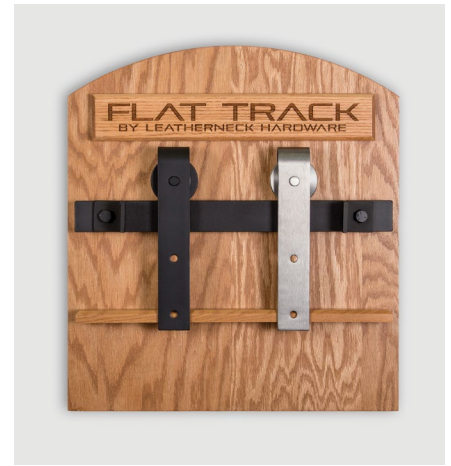

## Custom

If you have space for a full-size door display, special pricing is available for Flat Track kits.

Leatherneck Hardware Inc. has been a family owned and operated business since 1977. From the beginning, our goal has been to continually improve the design and manufacture of sliding hardware. We have grown from a small component supplier to the highly specialized company we are today.

Our lines of hardware include award-winning solutions for Aircraft Hangar Doors, Heavy-Duty Industrial Sliding and Rolling Doors, Flat Track by Leatherneck Hardware, and the stylized line of Coburn Sliding Systems.

# FLAT TRACK

BY LEATHERNECK HARDWARE



Leatherneck Hardware, Inc.

P.O. Box 1142, Danville, Illinois 61834

888.442.4572 • 217.442.4572 phone • 217.442.3613 fax

info@doorhdwe.com • www.doorhdwe.com

